

JEFFERSON MATH PROJECT

REGENTS BY TYPE

The NY Geometry Regents Exams
Fall 2008-August 2009

www.jmap.org

Dear Sir

I have to acknowledge the receipt of your favor of May 14. in which you mention that you have finished the 6. first books of Euclid, plane trigonometry, surveying & algebra and ask whether I think a further pursuit of that branch of science would be useful to you. there are some propositions in the latter books of Euclid, & some of Archimedes, which are useful, & I have no doubt you have been made acquainted with them. trigonometry, so far as this, is most valuable to every man, there is scarcely a day in which he will not resort to it for some of the purposes of common life. the science of calculation also is indispensable as far as the extraction of the square & cube roots; Algebra as far as the quadratic equation & the use of logarithms are often of value in ordinary cases: but all beyond these is but a luxury; a delicious luxury indeed; but not to be indulged in by one who is to have a profession to follow for his subsistence. in this light I view the conic sections, curves of the higher orders, perhaps even spherical trigonometry, Algebraical operations beyond the 2d dimension, and fluxions.

Letter from Thomas Jefferson to William G. Munford, Monticello, June 18, 1799.

Geometry Multiple Choice Regents Exam Questions

1. 080921ge, G.G.72

Which equation represents circle K shown in the graph below?

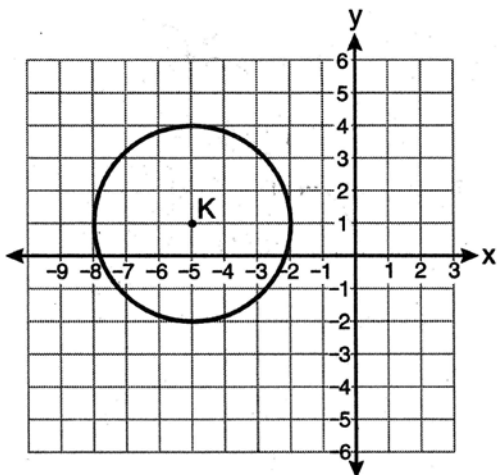

- a. $(x + 5)^2 + (y - 1)^2 = 3$
- b. $(x + 5)^2 + (y - 1)^2 = 9$
- c. $(x - 5)^2 + (y + 1)^2 = 3$
- d. $(x - 5)^2 + (y + 1)^2 = 9$

2. 060926ge, G.G.63

Which equation represents a line perpendicular to the line whose equation is $2x + 3y = 12$?

- a. $6y = -4x + 12$
- b. $2y = 3x + 6$
- c. $2y = -3x + 6$
- d. $3y = -2x + 12$

3. 060928ge, G.G.8

In three-dimensional space, two planes are parallel and a third plane intersects both of the parallel planes. The intersection of the planes is a

- a. plane
- b. point
- c. pair of parallel lines
- d. pair of intersecting lines

4. 060907ge, G.G.64

What is an equation of the line that passes through the point $(-2, 5)$ and is perpendicular to the line

whose equation is $y = \frac{1}{2}x + 5$?

- a. $y = 2x + 1$
- b. $y = -2x + 1$
- c. $y = 2x + 9$
- d. $y = -2x - 9$

5. 080907ge, G.G.38

In the diagram below of parallelogram $ABCD$ with diagonals \overline{AC} and \overline{BD} , $m\angle 1 = 45$ and $m\angle DCB = 120$.

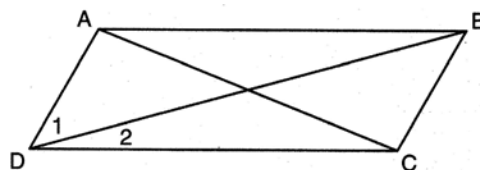

What is the measure of $\angle 2$?

- a. 15°
- b. 30°
- c. 45°
- d. 60°

Geometry Multiple Choice Regents Exam Questions

www.jmap.org

6. *fall0815ge, G.G.12*

A rectangular prism has a volume of $3x^2 + 18x + 24$. Its base has a length of $x + 2$ and a width of 3. Which expression represents the height of the prism?

- a. $x + 4$
- b. $x + 2$
- c. 3
- d. $x^2 + 6x + 8$

7. *080908ge, G.G.57*

On the set of axes below, Geoff drew rectangle $ABCD$. He will transform the rectangle by using the translation $(x,y) \rightarrow (x+2,y+1)$ and then will reflect the translated rectangle over the x -axis.

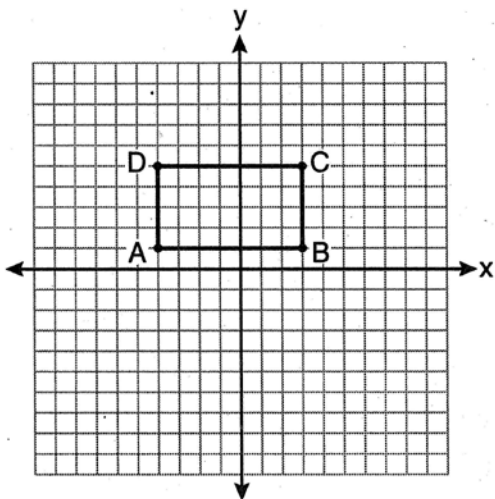

What will be the area of the rectangle after these transformations?

- a. exactly 28 square units
- b. less than 28 square units
- c. greater than 28 square units
- d. It cannot be determined from the information given.

8. *fall0816ge, G.G.1*

Lines k_1 and k_2 intersect at point E . Line m is perpendicular to lines k_1 and k_2 at point E .

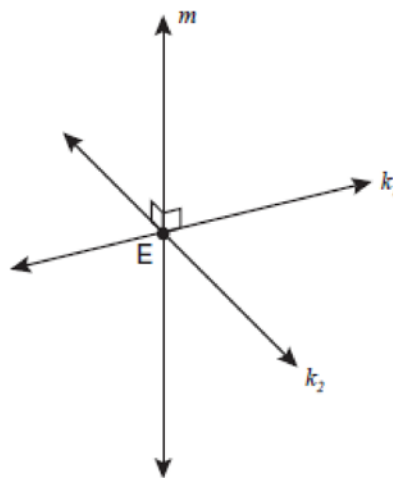

Which statement is always true?

- a. Lines k_1 and k_2 are perpendicular.
- b. Line m is parallel to the plane determined by lines k_1 and k_2 .
- c. Line m is perpendicular to the plane determined by lines k_1 and k_2 .
- d. Line m is coplanar with lines k_1 and k_2 .

9. *060923ge, G.G.70*

Given the system of equations:

$$y = x^2 - 4x$$

$$x = 4$$

The number of points of intersection is

- a. 1
- b. 2
- c. 3
- d. 0

Geometry Multiple Choice Regents Exam Questions

www.jmap.org

10. 080918ge, G.G.41

A quadrilateral whose diagonals bisect each other and are perpendicular is a

- rhombus
- rectangle
- trapezoid
- parallelogram

11. 060917ge, G.G.44

In the diagram of $\triangle ABC$ and $\triangle EDC$ below, \overline{AE} and \overline{BD} intersect at C , and $\angle CAB \cong \angle CED$.

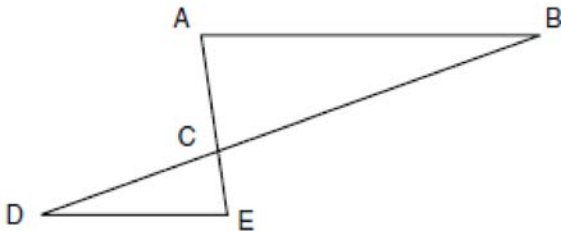

Which method can be used to show that $\triangle ABC$ must be similar to $\triangle EDC$?

- SAS
- AA
- SSS
- HL

12. fall0820ge, G.G.71

The diameter of a circle has endpoints at $(-2, 3)$ and $(6, 3)$. What is an equation of the circle?

- $(x - 2)^2 + (y - 3)^2 = 16$
- $(x - 2)^2 + (y - 3)^2 = 4$
- $(x + 2)^2 + (y + 3)^2 = 16$
- $(x + 2)^2 + (y + 3)^2 = 4$

13. 060915ge, G.G.47

In the diagram below, the length of the legs \overline{AC} and \overline{BC} of right triangle ABC are 6 cm and 8 cm, respectively. Altitude \overline{CD} is drawn to the hypotenuse of $\triangle ABC$.

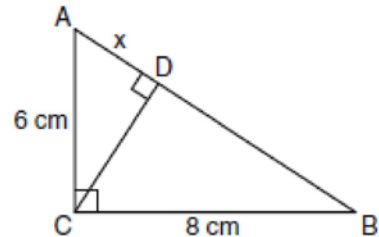

What is the length of \overline{AD} to the nearest tenth of a centimeter?

- 3.6
- 6.0
- 6.4
- 4.0

14. 080916ge, G.G.33

Which set of numbers represents the lengths of the sides of a triangle?

- $\{5, 18, 13\}$
- $\{6, 17, 22\}$
- $\{16, 24, 7\}$
- $\{26, 8, 15\}$

15. 060927ge, G.G.45

In $\triangle ABC$, point D is on \overline{AB} , and point E is on \overline{BC} such that $\overline{DE} \parallel \overline{AC}$. If $DB = 2$, $DA = 7$, and $DE = 3$, what is the length of \overline{AC} ?

- 8
- 9
- 10.5
- 13.5

Geometry Multiple Choice Regents Exam Questions

www.jmap.org

16. 080911ge, G.G.73

What are the center and the radius of the circle whose equation is $(x - 3)^2 + (y + 3)^2 = 36$

- a. center = (3, -3); radius = 6
- b. center = (-3, 3); radius = 6
- c. center = (3, -3); radius = 36
- d. center = (-3, 3); radius = 36

17. 080919ge, G.G.67

If the endpoints of \overline{AB} are $A(-4, 5)$ and $B(2, -5)$, what is the length of \overline{AB} ?

- a. $2\sqrt{34}$
- b. 2
- c. $\sqrt{61}$
- d. 8

18. fall0813ge, G.G.66

Line segment \overline{AB} has endpoints $A(2, -3)$ and $B(-4, 6)$. What are the coordinates of the midpoint of \overline{AB} ?

- a. (-2, 3)
- b. $\left(-1, 1\frac{1}{2}\right)$
- c. (-1, 3)
- d. $\left(3, 4\frac{1}{2}\right)$

19. fall0825ge, G.G.21

In which triangle do the three altitudes intersect outside the triangle?

- a. a right triangle
- b. an acute triangle
- c. an obtuse triangle
- d. an equilateral triangle

20. fall0823ge, G.G.58

The endpoints of \overline{AB} are $A(3, 2)$ and $B(7, 1)$. If $\overline{A''B''}$ is the result of the transformation of \overline{AB} under $D_2 \circ T_{-4, 3}$ what are the coordinates of A'' and B'' ?

- a. $A''(-2, 10)$ and $B''(6, 8)$
- b. $A''(-1, 5)$ and $B''(3, 4)$
- c. $A''(2, 7)$ and $B''(10, 5)$
- d. $A''(14, -2)$ and $B''(22, -4)$

21. 080927ge, G.G.4

If two different lines are perpendicular to the same plane, they are

- a. collinear
- b. coplanar
- c. congruent
- d. consecutive

22. 080903ge, G.G.31

In the diagram of $\triangle ABC$ below, $\overline{AB} \cong \overline{AC}$. The measure of $\angle B$ is 40° .

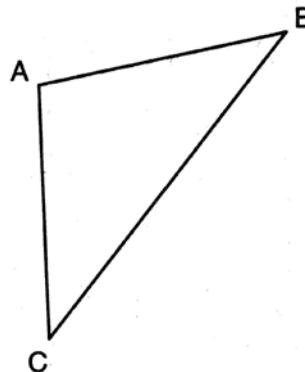

What is the measure of $\angle A$?

- a. 40°
- b. 50°
- c. 70°
- d. 100°

Geometry Multiple Choice Regents Exam Questions

www.jmap.org

23. *fall0814ge, G.G.73*

What are the center and radius of a circle whose equation is $(x - A)^2 + (y - B)^2 = C$?

- a. center = (A, B) ; radius = C
- b. center = $(-A, -B)$; radius = C
- c. center = (A, B) ; radius = \sqrt{C}
- d. center = $(-A, -B)$; radius = \sqrt{C}

24. *080912ge, G.G.70*

Given the equations: $y = x^2 - 6x + 10$

$$y + x = 4$$

What is the solution to the given system of equations?

- a. $(2, 3)$
- b. $(3, 2)$
- c. $(2, 2)$ and $(1, 3)$
- d. $(2, 2)$ and $(3, 1)$

25. *060905ge, G.G.54*

Point A is located at $(4, -7)$. The point is reflected in the x -axis. Its image is located at

- a. $(-4, 7)$
- b. $(-4, -7)$
- c. $(4, 7)$
- d. $(7, -4)$

26. *060911ge, G.G.34*

In $\triangle ABC$, $m\angle A = 95$, $m\angle B = 50$, and $m\angle C = 35$. Which expression correctly relates the lengths of the sides of this triangle?

- a. $AB < BC < CA$
- b. $AB < AC < BC$
- c. $AC < BC < AB$
- d. $BC < AC < AB$

27. *fall0822ge, G.G.63*

The lines $3y + 1 = 6x + 4$ and $2y + 1 = x - 9$ are

- a. parallel
- b. perpendicular
- c. the same line
- d. neither parallel nor perpendicular

28. *fall0801ge, G.G.40*

Isosceles trapezoid $ABCD$ has diagonals \overline{AC} and \overline{BD} . If $AC = 5x + 13$ and $BD = 11x - 5$, what is the value of x ?

- a. 28
- b. $10\frac{3}{4}$
- c. 3
- d. $\frac{1}{2}$

29. *080928ge, G.G.50*

How many common tangent lines can be drawn to the two externally tangent circles shown below?

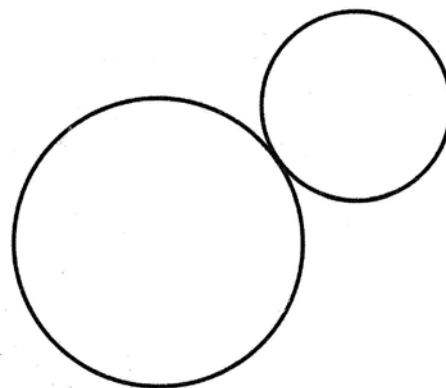

- a. 1
- b. 2
- c. 3
- d. 4

Geometry Multiple Choice Regents Exam Questions

www.jmap.org

30. 080909ge, G.G.63

What is the equation of a line that is parallel to the line whose equation is $y = x + 2$?

- a. $x + y = 5$
- b. $2x + y = -2$
- c. $y - x = -1$
- d. $y - 2x = 3$

31. 080906ge, G.G.59

Which transformation produces a figure similar but not congruent to the original figure?

- a. $T_{1,3}$
- b. $D_{\frac{1}{2}}$
- c. R_{90°
- d. $r_{y=x}$

32. 060914ge, G.G.43

In the diagram of $\triangle ABC$ below, Jose found centroid P by constructing the three medians. He measured CF and found it to be 6 inches.

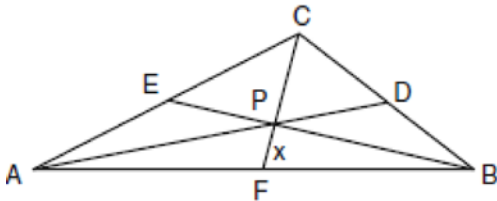

If $PF = x$, which equation can be used to find x ?

- a. $x + x = 6$
- b. $2x + x = 6$
- c. $3x + 2x = 6$
- d. $x + \frac{2}{3}x = 6$

33. 080923ge, G.G.53

In the diagram of circle O below, chord \overline{AB} intersects chord \overline{CD} at E , $DE = 2x + 8$, $EC = 3$, $AE = 4x - 3$, and $EB = 4$.

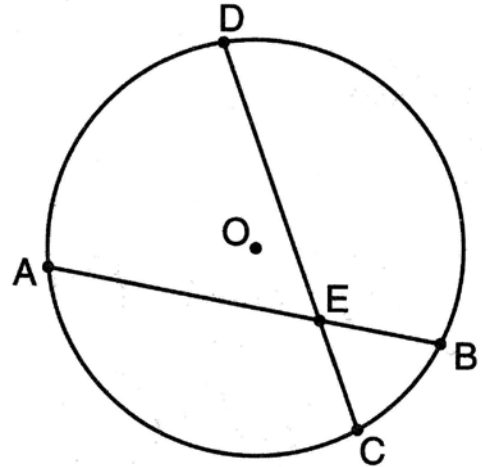

What is the value of x ?

- a. 1
- b. 3.6
- c. 5
- d. 10.25

34. fall0818ge, G.G.61

A polygon is transformed according to the rule: $(x,y) \rightarrow (x+2,y)$. Every point of the polygon moves two units in which direction?

- a. up
- b. down
- c. left
- d. right

Geometry Multiple Choice Regents Exam Questions

www.jmap.org

35. 080924ge, G.G.24

What is the negation of the statement "Squares are parallelograms"?

- Parallelograms are squares.
- Parallelograms are not squares.
- It is not the case that squares are parallelograms.
- It is not the case that parallelograms are squares.

36. 060906ge, G.G.52

In the diagram of circle O below, chords \overline{AB} and \overline{CD} are parallel, and \overline{BD} is a diameter of the circle.

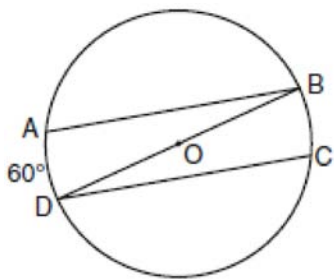

If $m\widehat{AD} = 60$, what is $m\angle CDB$?

- 20
- 30
- 60
- 120

37. fall0809ge, G.G.31

The vertices of $\triangle ABC$ are $A(-1,-2)$, $B(-1,2)$ and $C(6,0)$. Which conclusion can be made about the angles of $\triangle ABC$?

- $m\angle A = m\angle B$
- $m\angle A = m\angle C$
- $m\angle ACB = 90$
- $m\angle ABC = 60$

38. fall0821ge, G.G.44

In the diagram below of $\triangle PRT$, Q is a point on \overline{PR} , S is a point on \overline{TR} , \overline{QS} is drawn, and $\angle RPT \cong \angle RSQ$.

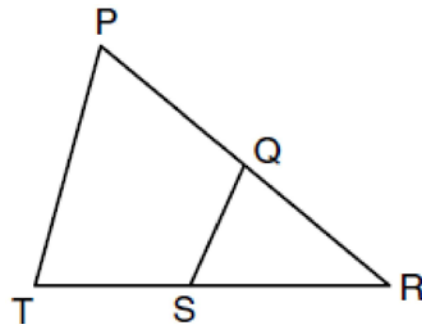

Which reason justifies the conclusion that $\triangle PRT \sim \triangle SRQ$?

- AA
- ASA
- SAS
- SSS

39. 060901ge, G.G.30

Juliann plans on drawing $\triangle ABC$, where the measure of $\angle A$ can range from 50° to 60° and the measure of $\angle B$ can range from 90° to 100° . Given these conditions, what is the correct range of measures possible for $\angle C$?

- 20° to 40°
- 30° to 50°
- 80° to 90°
- 120° to 130°

Geometry Multiple Choice Regents Exam Questions

www.jmap.org

40. 080902ge, G.G.17

The diagram below shows the construction of the bisector of $\angle ABC$.

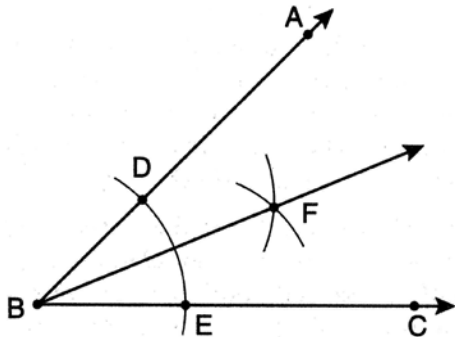

Which statement is *not* true?

- a. $m\angle EBF = \frac{1}{2} m\angle ABC$
- b. $m\angle DBF = \frac{1}{2} m\angle ABC$
- c. $m\angle EBF = m\angle ABC$
- d. $m\angle DBF = m\angle EBF$

41. 080917ge, G.G.62

What is the slope of a line perpendicular to the line whose equation is $y = -\frac{2}{3}x - 5$?

- a. $-\frac{3}{2}$
- b. $-\frac{2}{3}$
- c. $\frac{2}{3}$
- d. $\frac{3}{2}$

42. 060904ge, G.G.13

The lateral faces of a regular pyramid are composed of

- a. squares
- b. rectangles
- c. congruent right triangles
- d. congruent isosceles triangles

43. fall0810ge, G.G.24

Given $\triangle ABC$ with base \overline{AFEDC} , median \overline{BF} , altitude \overline{BD} , and \overline{BE} bisects $\angle ABC$, which conclusion is valid?

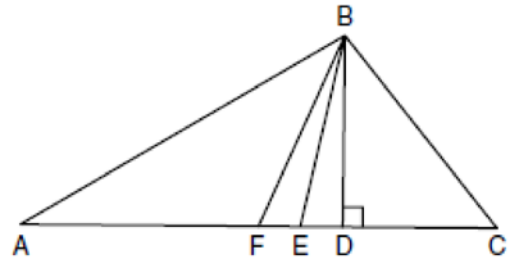

- a. $\angle FAB \cong \angle ABF$
- b. $\angle ABF \cong \angle CBD$
- c. $\overline{CE} \cong \overline{EA}$
- d. $\overline{CF} \cong \overline{FA}$

44. 080910ge, G.G.66

The endpoints of \overline{CD} are $C(-2, -4)$ and $D(6, 2)$.

What are the coordinates of the midpoint of \overline{CD} ?

- a. $(2, 3)$
- b. $(2, -1)$
- c. $(4, -2)$
- d. $(4, 3)$

Geometry Multiple Choice Regents Exam Questions

www.jmap.org

45. 080920ge, G.G.42

In the diagram below of $\triangle ACT$, D is the midpoint of \overline{AC} , O is the midpoint of \overline{AT} , and G is the midpoint of \overline{CT} .

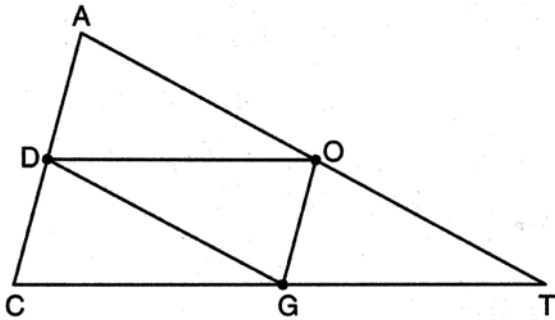

If $AC = 10$, $AT = 18$, and $CT = 22$, what is the perimeter of parallelogram $CDOG$?

- a. 21
- b. 25
- c. 32
- d. 40

46. 060925ge, G.G.17

Which illustration shows the correct construction of an angle bisector?

- a.
- b.
- c.
- d.

47. 060908ge, G.G.60

After a composition of transformations, the coordinates $A(4,2)$, $B(4,6)$, and $C(2,6)$ become $A''(-2,-1)$, $B''(-2,-3)$, and $C''(-1,-3)$, as shown on the set of axes below.

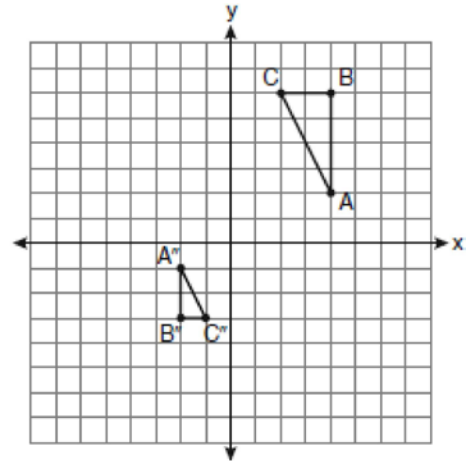

Which composition of transformations was used?

- a. $R_{180^\circ} \circ D_2$
- b. $R_{90^\circ} \circ D_2$
- c. $D_{\frac{1}{2}} \circ R_{180^\circ}$
- d. $D_{\frac{1}{2}} \circ R_{90^\circ}$

48. 060910ge, G.G.71

What is an equation of a circle with its center at $(-3,5)$ and a radius of 4?

- a. $(x-3)^2 + (y+5)^2 = 16$
- b. $(x+3)^2 + (y-5)^2 = 16$
- c. $(x-3)^2 + (y+5)^2 = 4$
- d. $(x+3)^2 + (y-5)^2 = 4$

Geometry Multiple Choice Regents Exam Questions

www.jmap.org

49. 060921ge, G.G.15

In the diagram below, a right circular cone has a diameter of 8 inches and a height of 12 inches.

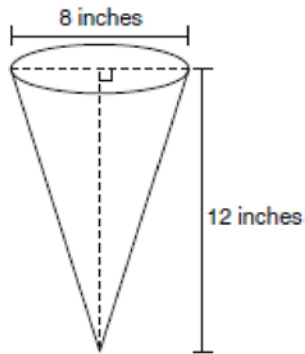

What is the volume of the cone to the *nearest cubic inch*?

- a. 201
- b. 481
- c. 603
- d. 804

50. fall0819ge, G.G.33

In the diagram below of $\triangle ABC$, D is a point on \overline{AB} , $AC = 7$, $AD = 6$, and $BC = 18$.

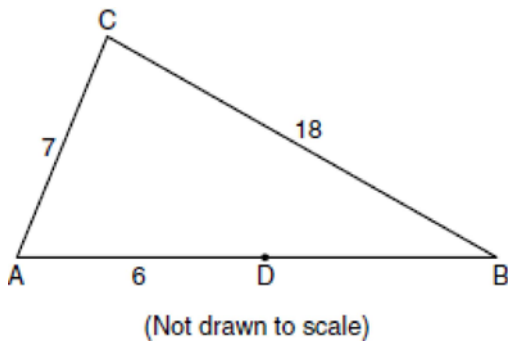

The length of \overline{DB} could be

- a. 5
- b. 12
- c. 19
- d. 25

51. fall0824ge, G.G.50

In the diagram below, circle A and circle B are shown.

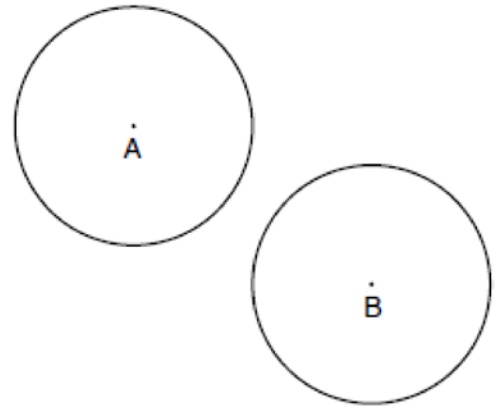

What is the total number of lines of tangency that are common to circle A and circle B ?

- a. 1
- b. 2
- c. 3
- d. 4

52. 060922ge, G.G.73

A circle is represented by the equation $x^2 + (y + 3)^2 = 13$. What are the coordinates of the center of the circle and the length of the radius?

- a. (0,3) and 13
- b. (0,3) and $\sqrt{13}$
- c. (0,-3) and 13
- d. (0,-3) and $\sqrt{13}$

Geometry Multiple Choice Regents Exam Questions

www.jmap.org

53. 080904ge, G.G.52

In the diagram of circle O below, chord \overline{CD} is parallel to diameter \overline{AOB} and $m\widehat{AC} = 30$.

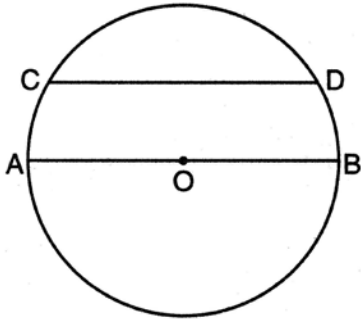

What is $m\widehat{CD}$?

- a. 150
- b. 120
- c. 100
- d. 60

54. fall0808ge, G.G.10

The figure in the diagram below is a triangular prism.

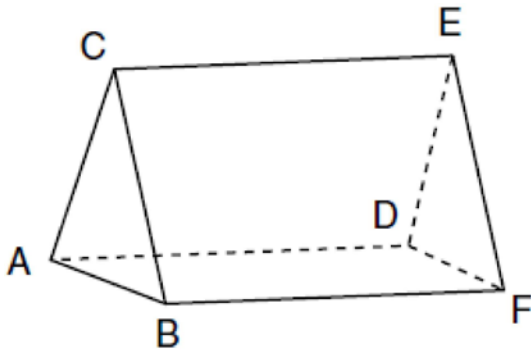

Which statement must be true?

- a. $\overline{DE} \cong \overline{AB}$
- b. $\overline{AD} \cong \overline{BC}$
- c. $\overline{AD} \parallel \overline{CE}$
- d. $\overline{DE} \parallel \overline{BC}$

55. fall0804ge, G.G.18

The diagram below shows the construction of the perpendicular bisector of \overline{AB} .

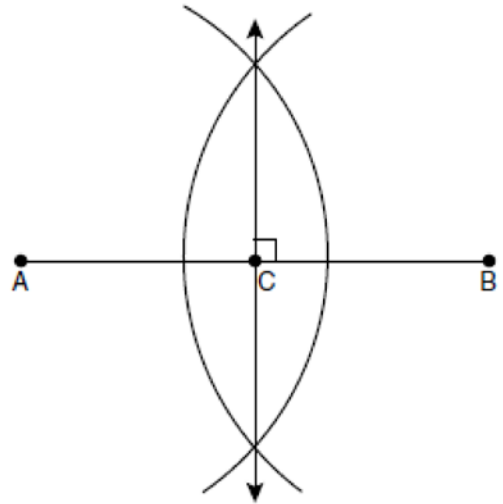

Which statement is *not* true?

- a. $AC = CB$
- b. $CB = \frac{1}{2}AB$
- c. $AC = 2AB$
- d. $AC + CB = AB$

56. 060924ge, G.G.33

Side \overline{PQ} of $\triangle PQR$ is extended through Q to point T . Which statement is *not* always true?

- a. $m\angle RQT > m\angle R$
- b. $m\angle RQT > m\angle P$
- c. $m\angle RQT = m\angle P + m\angle R$
- d. $m\angle RQT > m\angle PQR$

57. 080925ge, G.G.21

The diagram below shows the construction of the center of the circle circumscribed about $\triangle ABC$.

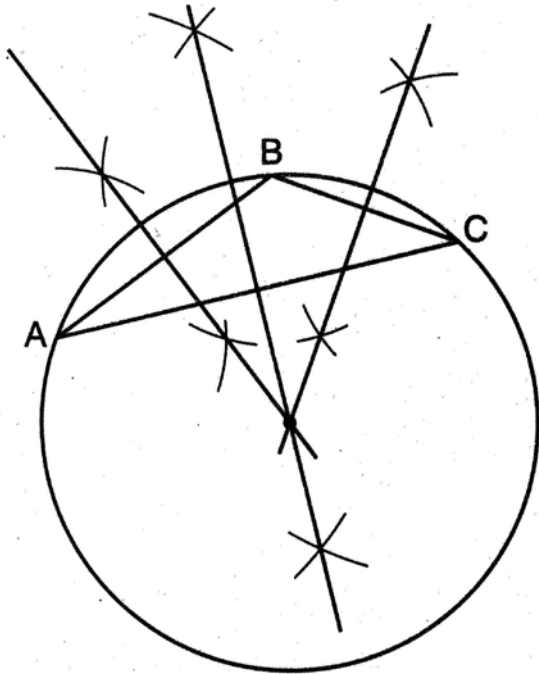

This construction represents how to find the intersection of

- a. the angle bisectors of $\triangle ABC$
- b. the medians to the sides of $\triangle ABC$
- c. the altitudes to the sides of $\triangle ABC$
- d. the perpendicular bisectors of the sides of $\triangle ABC$

58. 080926ge, G.G.14

A right circular cylinder has a volume of 1,000 cubic inches and a height of 8 inches. What is the radius of the cylinder to the nearest tenth of an inch?

- a. 6.3
- b. 11.2
- c. 19.8
- d. 39.8

59. fall0806ge, G.G.9

Line k is drawn so that it is perpendicular to two distinct planes, P and R . What must be true about planes P and R ?

- a. Planes P and R are skew.
- b. Planes P and R are parallel.
- c. Planes P and R are perpendicular.
- d. Plane P intersects plane R but is not perpendicular to plane R .

60. 080901ge, G.G.35

Based on the diagram below, which statement is true?

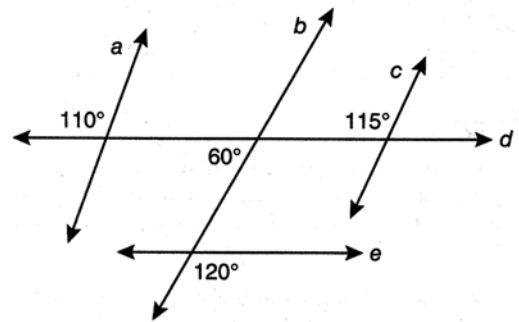

- a. $a \parallel b$
- b. $a \parallel c$
- c. $b \parallel c$
- d. $d \parallel e$

61. fall0802ge, G.G.24

What is the negation of the statement "The Sun is shining"?

- a. It is cloudy.
- b. It is daytime.
- c. It is not raining.
- d. The Sun is not shining.

Geometry Multiple Choice Regents Exam Questions

www.jmap.org

62. 080914ge, G.G.7

In the diagram below, line k is perpendicular to plane \mathcal{P} at point T .

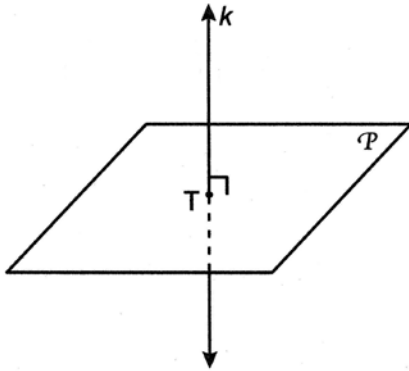

Which statement is true?

- Any point in plane \mathcal{P} also will be on line k .
- Only one line in plane \mathcal{P} will intersect line k .
- All planes that intersect plane \mathcal{P} will pass through T .
- Any plane containing line k is perpendicular to plane \mathcal{P} .

63. 060913ge, G.G.26

What is the contrapositive of the statement, "If I am tall, then I will bump my head"?

- If I bump my head, then I am tall.
- If I do not bump my head, then I am tall.
- If I am tall, then I will not bump my head.
- If I do not bump my head, then I am not tall.

64. fall0827ge, G.G.37

What is the measure of an interior angle of a regular octagon?

- 45°
- 60°
- 120°
- 135°

65. 080913ge, G.G.28

The diagonal \overline{AC} is drawn in parallelogram $ABCD$. Which method can *not* be used to prove that $\triangle ABC \cong \triangle CDA$?

- SSS
- SAS
- SSA
- ASA

66. fall0807ge, G.G.19

The diagram below illustrates the construction of \overleftrightarrow{PS} parallel to \overleftrightarrow{RQ} through point P .

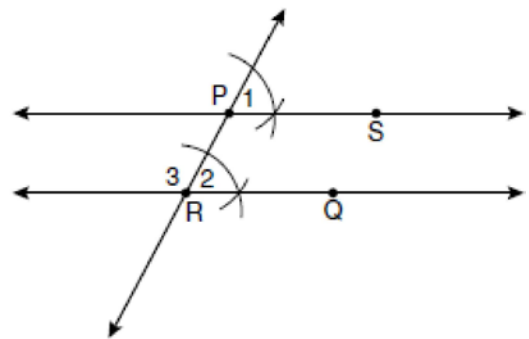

Which statement justifies this construction?

- $m\angle 1 = m\angle 2$
- $m\angle 1 = m\angle 3$
- $\overline{PR} \cong \overline{RQ}$
- $\overline{PS} \cong \overline{RQ}$

67. 060909ge, G.G.30

In an equilateral triangle, what is the difference between the sum of the exterior angles and the sum of the interior angles?

- 180°
- 120°
- 90°
- 60°

Geometry Multiple Choice Regents Exam Questions

www.jmap.org

68. *fall0828ge, G.G.62*

What is the slope of a line perpendicular to the line whose equation is $5x + 3y = 8$?

- a. $\frac{5}{3}$
- b. $\frac{3}{5}$
- c. $-\frac{3}{5}$
- d. $-\frac{5}{3}$

69. *060919ge, G.G.66*

Square $LMNO$ is shown in the diagram below.

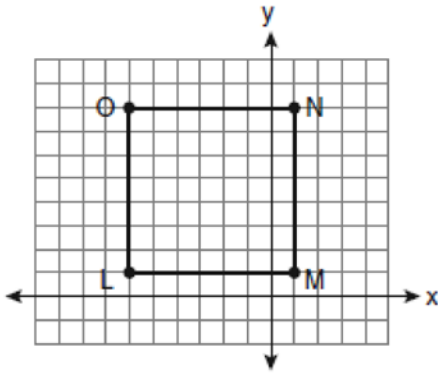

What are the coordinates of the midpoint of diagonal \overline{LN} ?

- a. $\left(4\frac{1}{2}, -2\frac{1}{2}\right)$
- b. $\left(-3\frac{1}{2}, 3\frac{1}{2}\right)$
- c. $\left(-2\frac{1}{2}, 3\frac{1}{2}\right)$
- d. $\left(-2\frac{1}{2}, 4\frac{1}{2}\right)$

70. *060916ge, G.G.53*

In the diagram below, tangent \overline{AB} and secant \overline{ACD} are drawn to circle O from an external point A , $AB = 8$, and $AC = 4$.

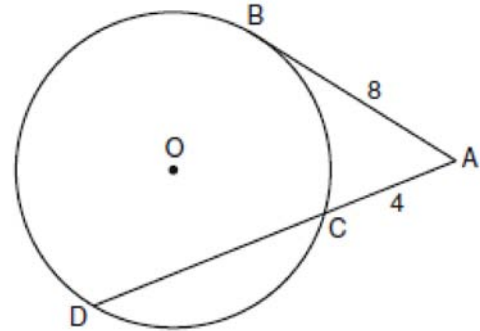

What is the length of \overline{CD} ?

- a. 16
- b. 13
- c. 12
- d. 10

71. *080905ge, G.G.29*

In the diagram of trapezoid $ABCD$ below, diagonals \overline{AC} and \overline{BD} intersect at E and $\triangle ABC \cong \triangle DCB$.

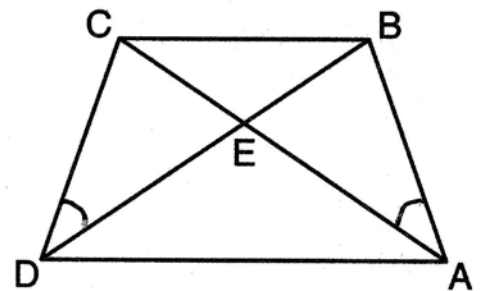

Which statement is true based on the given information?

- a. $\overline{AC} \cong \overline{BC}$
- b. $\overline{CD} \cong \overline{AD}$
- c. $\angle CDE \cong \angle BAD$
- d. $\angle CDB \cong \angle BAC$

72. *fall0811ge, G.G.49*

In the diagram below, circle O has a radius of 5, and $\overline{CE} = 2$. Diameter \overline{AC} is perpendicular to chord \overline{BD} at E .

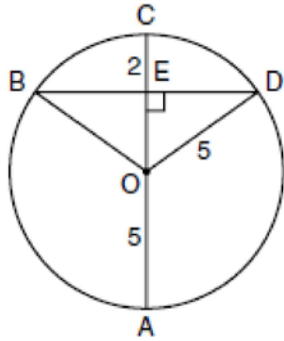

What is the length of \overline{BD} ?

- a. 12
- b. 10
- c. 8
- d. 4

73. *060918ge, G.G.2*

Point P is on line m . What is the total number of planes that are perpendicular to line m and pass through point P ?

- a. 1
- b. 2
- c. 0
- d. infinite

74. *060920ge, G.G.74*

Which graph represents a circle with the equation $(x - 5)^2 + (y + 1)^2 = 9$?

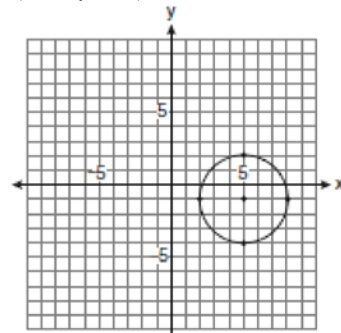

a.

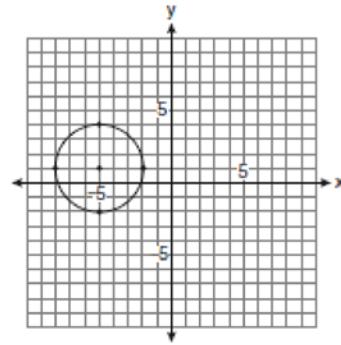

b.

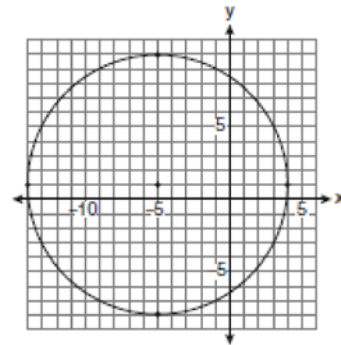

c.

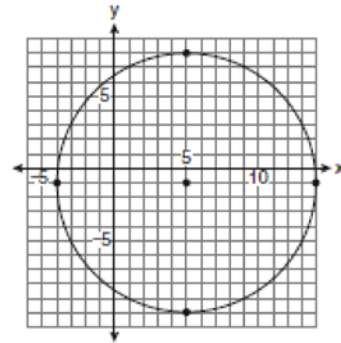

d.

Geometry Multiple Choice Regents Exam Questions

www.jmap.org

75. 080915ge, G.G.56

In the diagram below, which transformation was used to map $\triangle ABC$ to $\triangle A'B'C'$?

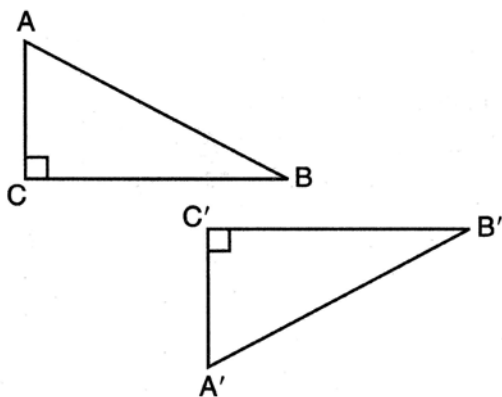

- a. dilation
- b. rotation
- c. reflection
- d. glide reflection

76. fall0826ge, G.G.45

Two triangles are similar, and the ratio of each pair of corresponding sides is 2 : 1. Which statement regarding the two triangles is *not* true?

- a. Their areas have a ratio of 4 : 1.
- b. Their altitudes have a ratio of 2 : 1.
- c. Their perimeters have a ratio of 2 : 1.
- d. Their corresponding angles have a ratio of 2 : 1.

77. 080922ge, G.G.47

In the diagram below of right triangle ACB , altitude \overline{CD} is drawn to hypotenuse \overline{AB} .

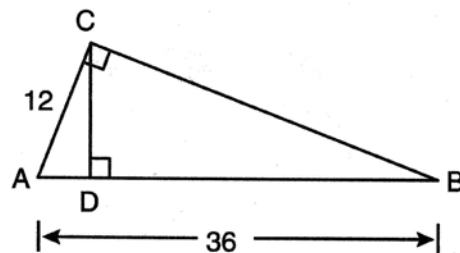

If $AB = 36$ and $AC = 12$, what is the length of \overline{AD} ?

- a. 32
- b. 6
- c. 3
- d. 4

78. 060902ge, G.G.28

In the diagram of $\triangle ABC$ and $\triangle DEF$ below, $\overline{AB} \cong \overline{DE}$, $\angle A \cong \angle D$, and $\angle B \cong \angle E$.

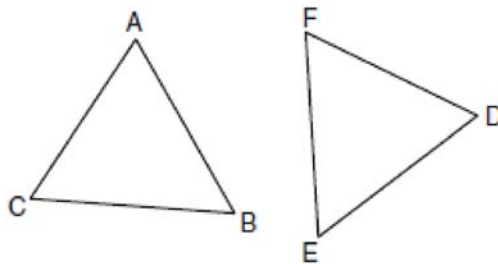

Which method can be used to prove $\triangle ABC \cong \triangle DEF$?

- a. SSS
- b. SAS
- c. ASA
- d. HL

Geometry Multiple Choice Regents Exam Questions

www.jmap.org

79. *fall0817ge, G.G.53*

In the diagram below, \overline{PS} is a tangent to circle O at point S , \overline{PQR} is a secant, $PS = x$, $PQ = 3$, and $PR = x + 18$.

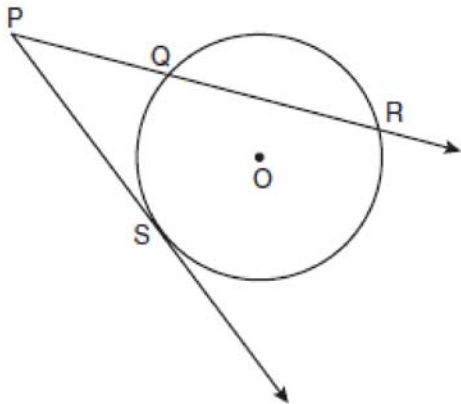

(Not drawn to scale)

What is the length of \overline{PS} ?

- a. 6
- b. 9
- c. 3
- d. 27

80. *fall0803ge, G.G.54*

Triangle ABC has vertices $A(1,3)$, $B(0,1)$, and $C(4,0)$. Under a translation, A' , the image point of A , is located at $(4,4)$. Under this same translation, point C' is located at

- a. $(7,1)$
- b. $(5,3)$
- c. $(3,2)$
- d. $(1,-1)$

81. *fall0812ge, G.G.65*

What is the equation of a line that passes through the point $(-3, -11)$ and is parallel to the line whose equation is $2x - y = 4$?

- a. $y = 2x + 5$
- b. $y = 2x - 5$
- c. $y = \frac{1}{2}x + \frac{25}{2}$
- d. $y = -\frac{1}{2}x - \frac{25}{2}$

82. *060912ge, G.G.22*

In a coordinate plane, how many points are both 5 units from the origin and 2 units from the x -axis?

- a. 1
- b. 2
- c. 3
- d. 4

83. *060903ge, G.G.56*

In the diagram below, under which transformation will $\triangle A'B'C'$ be the image of $\triangle ABC$?

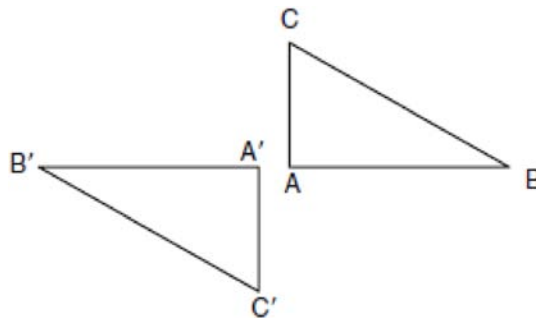

- a. rotation
- b. dilation
- c. translation
- d. glide reflection

84. *fall0805ge, G.G.70*

Which graph could be used to find the solution to the following system of equations?

$$y = -x + 2$$

$$y = x^2$$

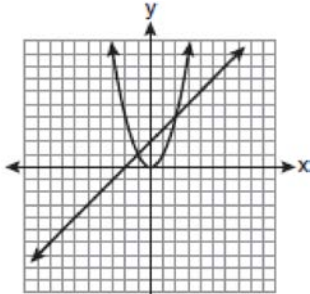

a.

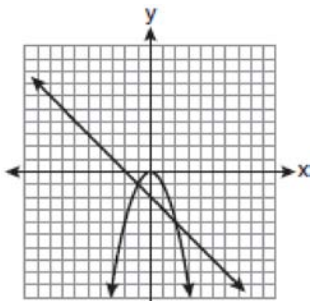

b.

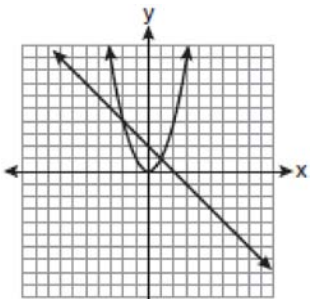

c.

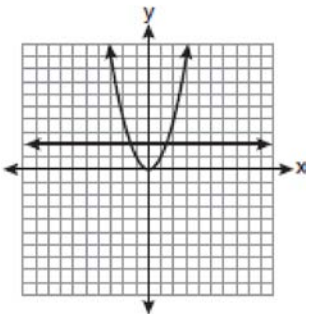

d.

Geometry 2 Point Regents Exam Questions

1. *fall0832ge, G.G.17*

Using a compass and straightedge, construct the bisector of the angle shown below. [*Leave all construction marks.*]

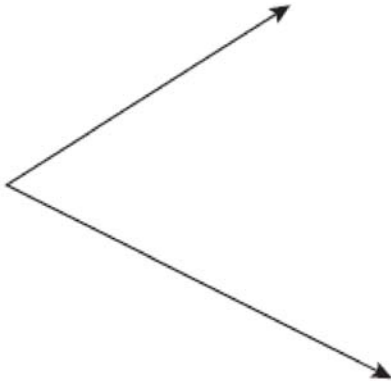

2. *060934ge, G.G.45*

In the diagram below, $\triangle ABC \sim \triangle EFG$, $m\angle C = 4x + 30$, and $m\angle G = 5x + 10$. Determine the value of x .

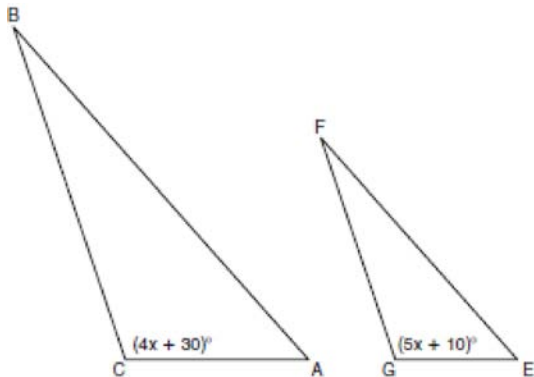

3. *fall0831ge, G.G.67*

The endpoints of \overline{PQ} are $P(-3, 1)$ and $Q(4, 25)$. Find the length of \overline{PQ} .

4. *060931ge, G.G.65*

Find an equation of the line passing through the point $(5, 4)$ and parallel to the line whose equation is $2x + y = 3$.

5. *080929ge, G.G.40*

In the diagram below of isosceles trapezoid $DEFG$, $\overline{DE} \parallel \overline{GF}$, $DE = 4x - 2$, $EF = 3x + 2$, $FG = 5x - 3$, and $GD = 2x + 5$. Find the value of x .

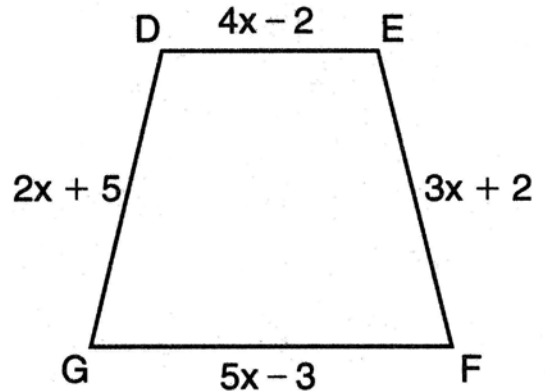

6. *080933ge, G.G.30*

The degree measures of the angles of $\triangle ABC$ are represented by x , $3x$, and $5x - 54$. Find the value of x .

7. *060933ge, G.G.25*

Given: Two is an even integer or three is an even integer.
Determine the truth value of this disjunction.
Justify your answer.

Geometry 2 Point Regents Exam Questions

www.jmap.org

8. 060930ge, G.G.19

Using a compass and straightedge, construct a line that passes through point P and is perpendicular to line m . [Leave all construction marks.]

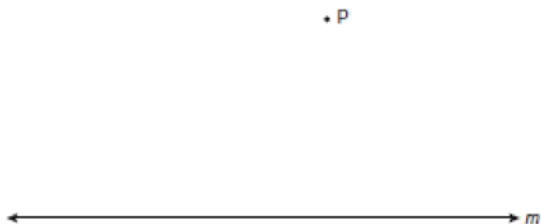

9. 080934ge, G.G.34

In the diagram below of $\triangle ABC$ with side \overline{AC} extended through D , $m\angle A = 37$ and $m\angle BCD = 117$. Which side of $\triangle ABC$ is the longest side? Justify your answer.

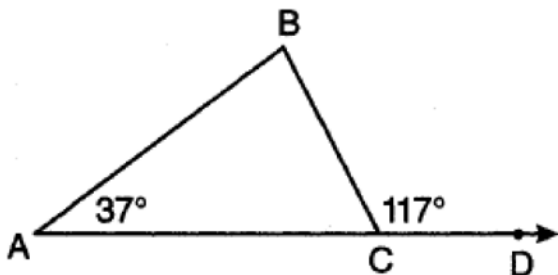

(Not drawn to scale)

10. 080930ge, G.G.13

A regular pyramid with a square base is shown in the diagram below.

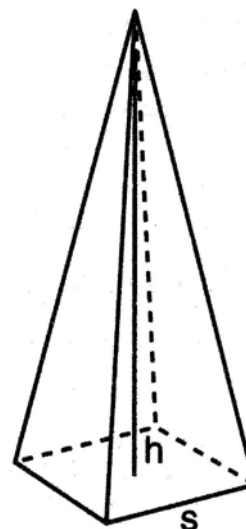

A side, s , of the base of the pyramid is 12 meters, and the height, h , is 42 meters. What is the volume of the pyramid in cubic meters?

11. 080931ge, G.G.65

Write an equation of the line that passes through the point $(6, -5)$ and is parallel to the line whose equation is $2x - 3y = 11$.

12. fall0834ge, G.G.26

Write a statement that is logically equivalent to the statement "If two sides of a triangle are congruent, the angles opposite those sides are congruent." Identify the new statement as the converse, inverse, or contrapositive of the original statement.

Geometry 2 Point Regents Exam Questions

www.jmap.org

13. 080932ge, G.G.17

Using a compass and straightedge, construct the angle bisector of $\angle ABC$ shown below. [Leave all construction marks.]

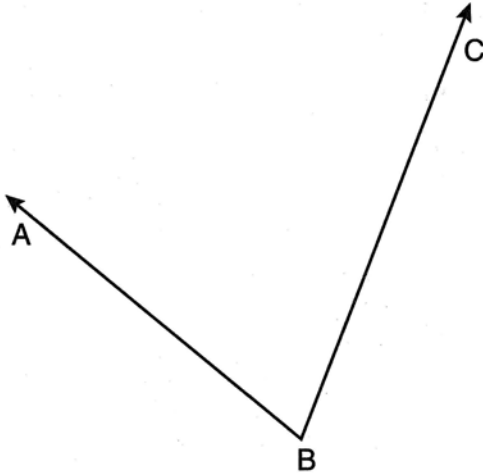

14. fall0829ge, G.G.47

In the diagram below of right triangle ACB , altitude \overline{CD} intersects \overline{AB} at D . If $AD = 3$ and $DB = 4$, find the length of \overline{CD} in simplest radical form.

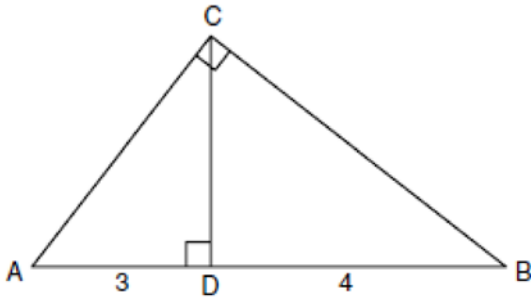

15. fall0833ge, G.G.14

The volume of a cylinder is $12,566.4 \text{ cm}^3$. The height of the cylinder is 8 cm. Find the radius of the cylinder to the nearest tenth of a centimeter.

16. fall0830ge, G.G.55

The vertices of $\triangle ABC$ are $A(3,2)$, $B(6,1)$, and $C(4,6)$. Identify and graph a transformation of $\triangle ABC$ such that its image, $\triangle A'B'C'$, results in $\overline{AB} \parallel \overline{A'B'}$.

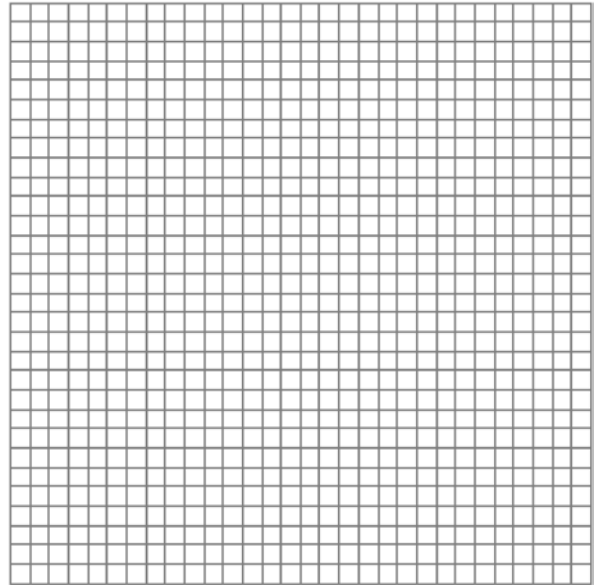

17. 060929ge, G.G.42

In the diagram of $\triangle ABC$ below, $AB = 10$, $BC = 14$, and $AC = 16$. Find the perimeter of the triangle formed by connecting the midpoints of the sides of $\triangle ABC$.

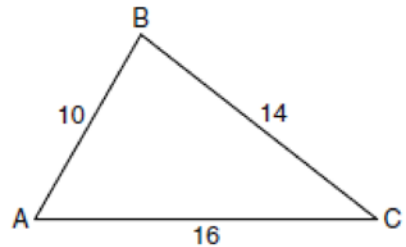

Geometry 2 Point Regents Exam Questions

www.jmap.org

18. 060932ge, G.G.22

The length of \overline{AB} is 3 inches. On the diagram below, sketch the points that are equidistant from A and B and sketch the points that are 2 inches from A . Label with an **X** all points that satisfy both conditions.



Geometry 4 Point Regents Exam Questions

1. 060936ge, G.G.69

Triangle ABC has coordinates $A(-6,2)$, $B(-3,6)$, and $C(5,0)$. Find the perimeter of the triangle.

Express your answer in simplest radical form. [The use of the grid below is optional.]

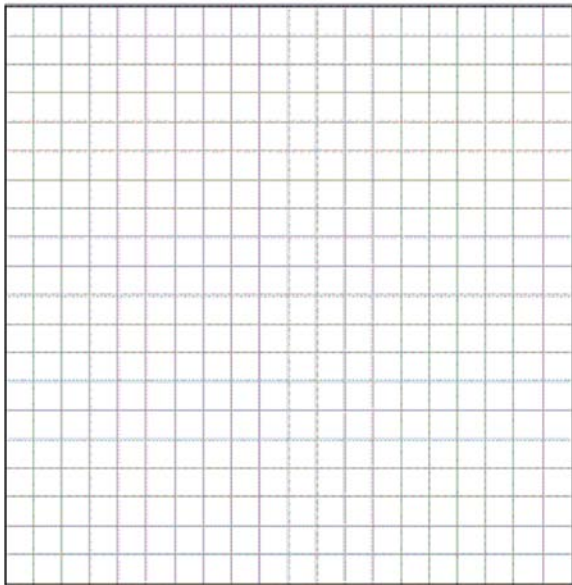

2. 080935ge, G.G.68

Write an equation of the perpendicular bisector of the line segment whose endpoints are $(-1,1)$ and $(7,-5)$. [The use of the grid below is optional]

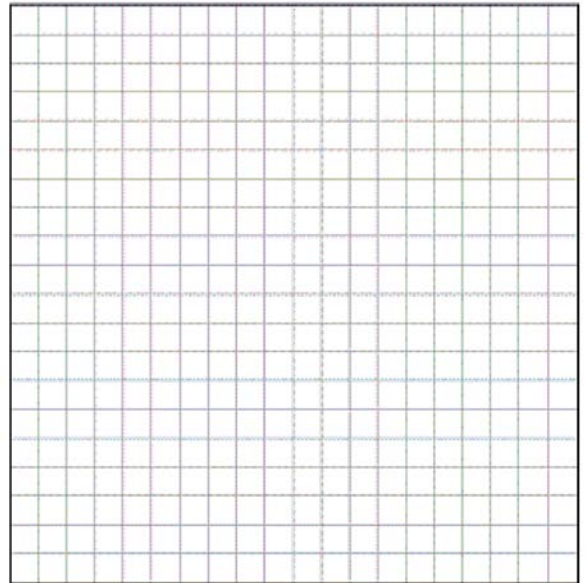

Geometry 4 Point Regents Exam Questions

www.jmap.org

3. *fall0837ge, G.G.23*

A city is planning to build a new park. The park must be equidistant from school A at $(3,3)$ and school B at $(3,-5)$. The park also must be exactly 5 miles from the center of town, which is located at the origin on the coordinate graph. Each unit on the graph represents 1 mile. On the set of axes below, sketch the compound loci and label with an **X** all possible locations for the new park.

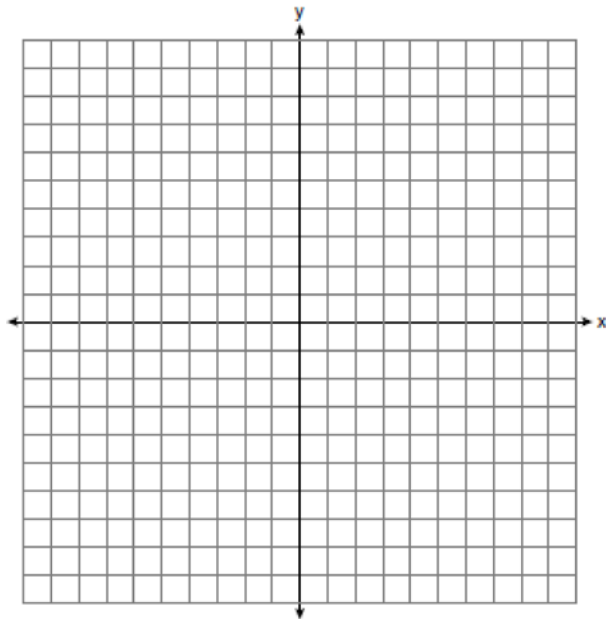

4. *060935ge, G.G.50*

In the diagram below, circles X and Y have two tangents drawn to them from external point T . The points of tangency are $C, A, S,$ and E . The ratio of \overline{TA} to \overline{AC} is $1:3$. If $TS = 24$, find the length of \overline{SE} .

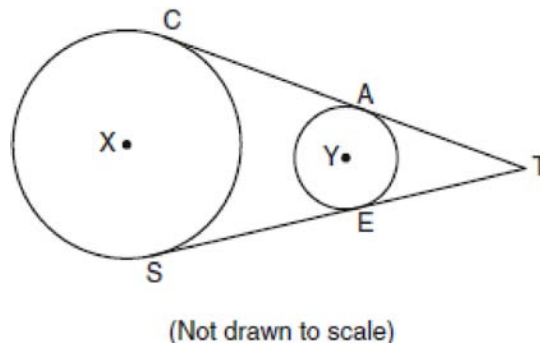

5. *fall0836ge, G.G.51*

In the diagram below of circle O , chords \overline{DF} , \overline{DE} , \overline{FG} , and \overline{EG} are drawn such that $m\widehat{DF} : m\widehat{FE} : m\widehat{EG} : m\widehat{GD} = 5 : 2 : 1 : 7$. Identify one pair of inscribed angles that are congruent to each other and give their measure.

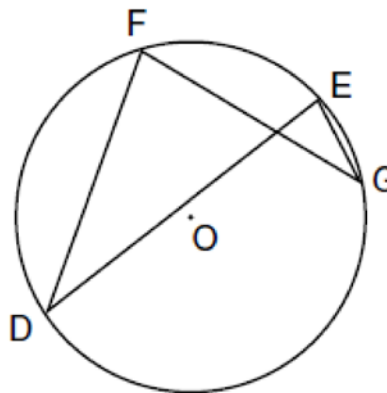

Geometry 4 Point Regents Exam Questions

www.jmap.org

6. 080937ge, G.G.55

Triangle DEG has the coordinates $D(1, 1)$, $E(5, 1)$, and $G(5, 4)$. Triangle DEG is rotated 90° about the origin to form $\triangle D'E'G'$. On the grid below, graph and label $\triangle DEG$ and $\triangle D'E'G'$. State the coordinates of the vertices D' , E' , and G' . Justify that this transformation preserves distance.

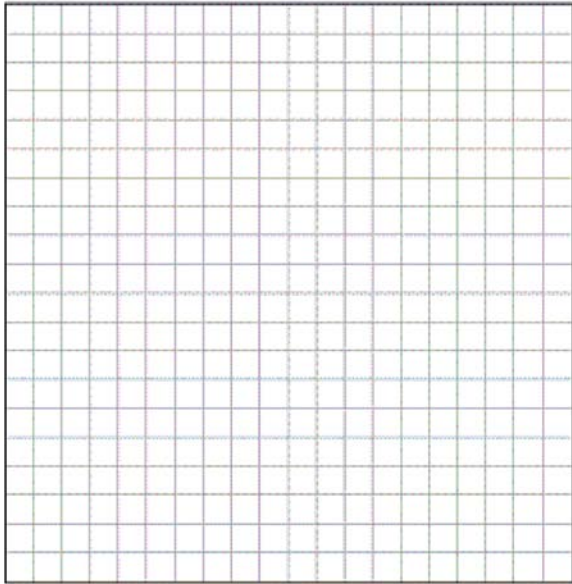

7. fall0835ge, G.G.42

On the set of axes below, graph and label $\triangle DEF$ with vertices at $D(-4, -4)$, $E(-2, 2)$, and $F(8, -2)$. If G is the midpoint of \overline{EF} and H is the midpoint of \overline{DF} , state the coordinates of G and H and label \overline{GH} . Explain why $\overline{GH} \parallel \overline{DE}$.

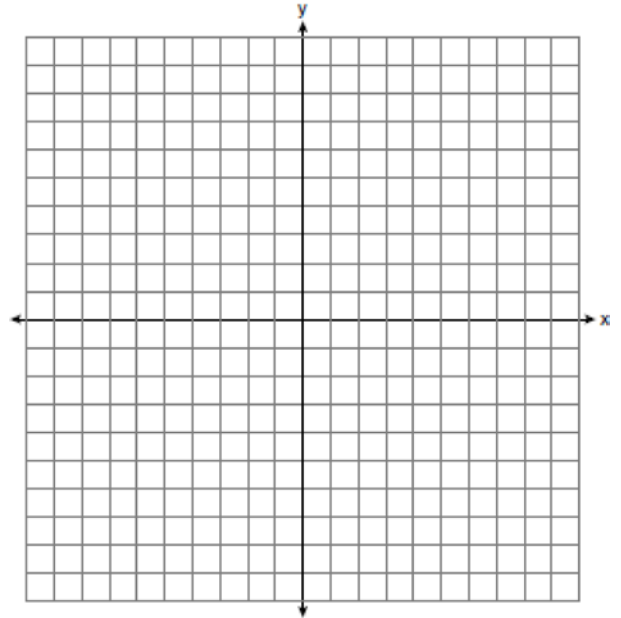

Geometry 4 Point Regents Exam Questions

www.jmap.org

8. 060937ge, G.G.58

The coordinates of the vertices of parallelogram $ABCD$ are $A(-2,2)$, $B(3,5)$, $C(4,2)$, and $D(-1,-1)$. State the coordinates of the vertices of parallelogram $A''B''C''D''$ that result from the transformation $r_{y\text{-axis}} \circ T_{2,-3}$. [The use of the set of axes below is optional.]

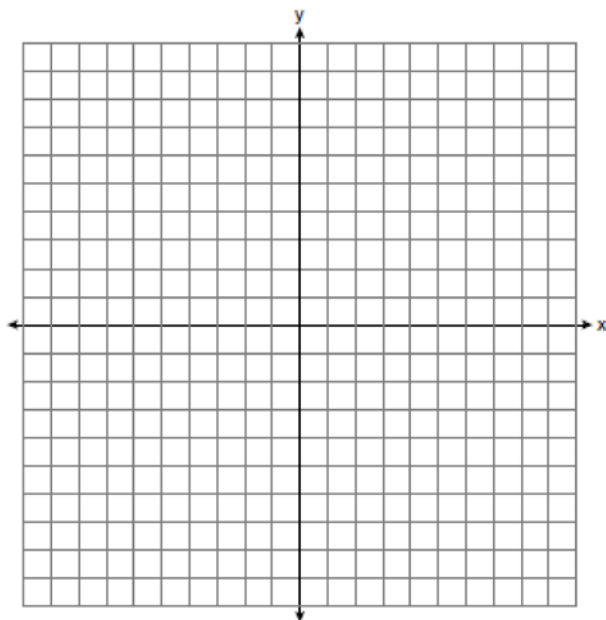

9. 080936ge, G.G.23

On the set of axes below, sketch the points that are 5 units from the origin and sketch the points that are 2 units from the line $y = 3$. Label with an **X** all points that satisfy both conditions.

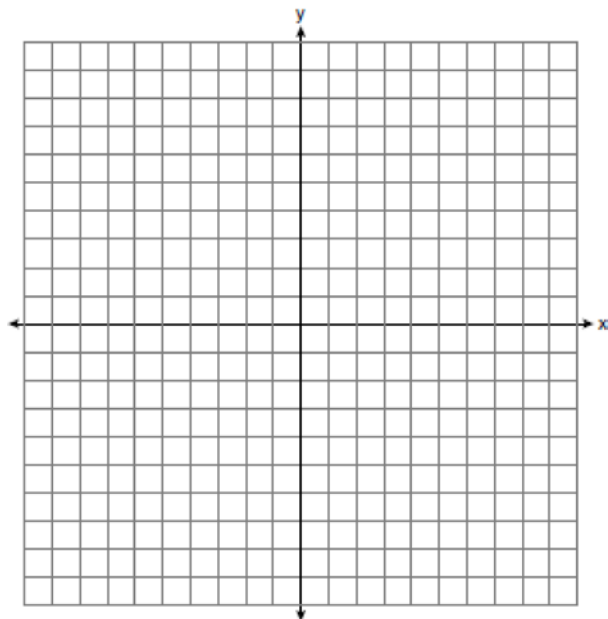

Geometry 6 Point Regents Exam Questions

1. *fall0838ge, G.G.28*

In the diagram below, quadrilateral $ABCD$ is inscribed in circle O , $\overline{AB} \parallel \overline{DC}$, and diagonals \overline{AC} and \overline{BD} are drawn. Prove that $\triangle ACD \cong \triangle BDC$.

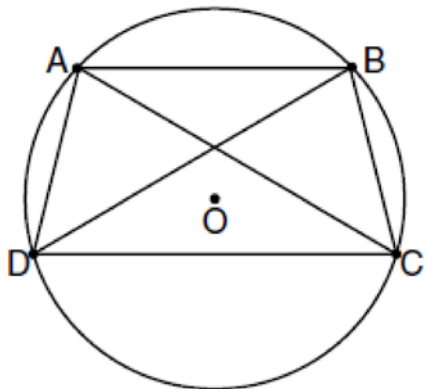

2. *060938ge, G.G.27*

Given: $\triangle ABC$ and $\triangle EDC$, C is the midpoint of \overline{BD} and \overline{AE}

Prove: $\overline{AB} \parallel \overline{DE}$

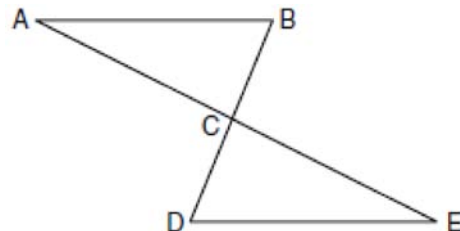

Geometry 6 Point Regents Exam Questions

www.jmap.org

3. 080938ge, G.G.27

Given: Quadrilateral $ABCD$, diagonal \overline{AFEC} ,

$\overline{AE} \cong \overline{FC}$, $\overline{BF} \perp \overline{AC}$, $\overline{DE} \perp \overline{AC}$, $\angle 1 \cong \angle 2$

Prove: $ABCD$ is a parallelogram.

