

JEFFERSON MATH PROJECT

REGENTS BY TYPE

The NY Integrated Algebra Regents Exams
Fall 2007-January 2012

www.jmap.org

Dear Sir

I have to acknowledge the receipt of your favor of May 14. in which you mention that you have finished the 6. first books of Euclid, plane trigonometry, surveying & algebra and ask whether I think a further pursuit of that branch of science would be useful to you. there are some propositions in the latter books of Euclid, & some of Archimedes, which are useful, & I have no doubt you have been made acquainted with them. trigonometry, so far as this, is most valuable to every man, there is scarcely a day in which he will not resort to it for some of the purposes of common life. the science of calculation also is indispensable as far as the extraction of the square & cube roots; Algebra as far as the quadratic equation & the use of logarithms are often of value in ordinary cases: but all beyond these is but a luxury; a delicious luxury indeed; but not to be indulged in by one who is to have a profession to follow for his subsistence. in this light I view the conic sections, curves of the higher orders, perhaps even spherical trigonometry, Algebraical operations beyond the 2d dimension, and fluxions.

Letter from Thomas Jefferson to William G. Munford, Monticello, June 18, 1799.

Integrated Algebra Multiple Choice Regents Exam Questions

- 1 Antwaan leaves a cup of hot chocolate on the counter in his kitchen. Which graph is the best representation of the change in temperature of his hot chocolate over time?

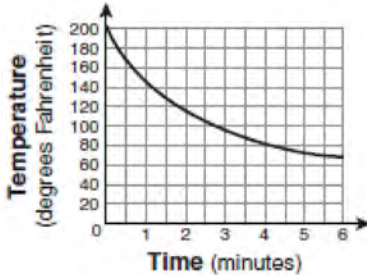

1)

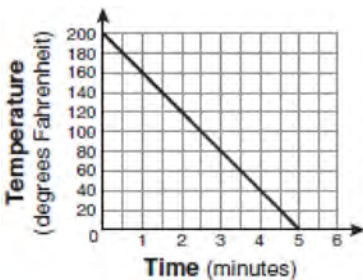

2)

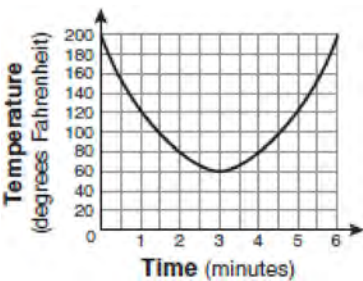

3)

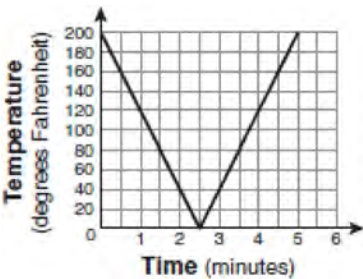

4)

- 2 Which point lies on the graph represented by the equation $3y + 2x = 8$?

- 1) $(-2, 7)$
- 2) $(0, 4)$
- 3) $(2, 4)$
- 4) $(7, -2)$

- 3 Which value of x makes the expression $\frac{x+4}{x-3}$ undefined?

- 1) -4
- 2) -3
- 3) 3
- 4) 0

- 4 Which situation should be analyzed using bivariate data?

- 1) Ms. Saleem keeps a list of the amount of time her daughter spends on her social studies homework.
- 2) Mr. Benjamin tries to see if his students' shoe sizes are directly related to their heights.
- 3) Mr. DeStefan records his customers' best video game scores during the summer.
- 4) Mr. Chan keeps track of his daughter's algebra grades for the quarter.

- 5 If h represents a number, which equation is a correct translation of "Sixty more than 9 times a number is 375"?

- 1) $9h = 375$
- 2) $9h + 60 = 375$
- 3) $9h - 60 = 375$
- 4) $60h + 9 = 375$

Integrated Algebra Multiple Choice Regents Exam Questions

www.jmap.org

6 The diagram below shows the graph of $y = |x - 3|$.

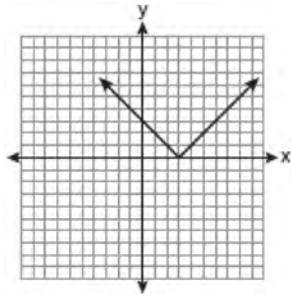

Which diagram shows the graph of $y = -|x - 3|$?

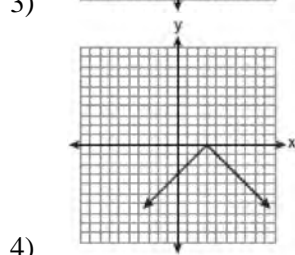
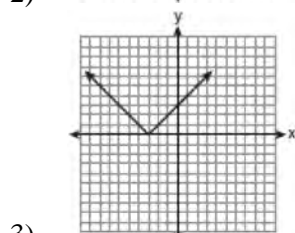
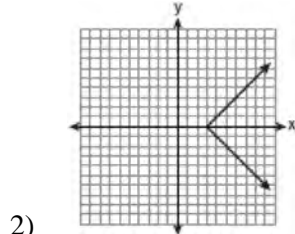
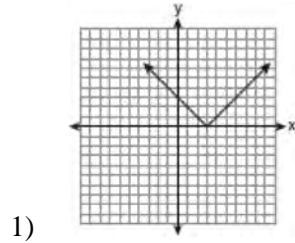

7 The length of a rectangular room is 7 less than three times the width, w , of the room. Which expression represents the area of the room?

- 1) $3w - 4$
- 2) $3w - 7$
- 3) $3w^2 - 4w$
- 4) $3w^2 - 7w$

8 What is the slope of the line that passes through the points $(2, -3)$ and $(5, 1)$?

- 1) $-\frac{2}{3}$
- 2) $\frac{2}{3}$
- 3) $-\frac{4}{3}$
- 4) $\frac{4}{3}$

9 Erica is conducting a survey about the proposed increase in the sports budget in the Hometown School District. Which survey method would likely contain the most bias?

- 1) Erica asks every third person entering the Hometown Grocery Store.
- 2) Erica asks every third person leaving the Hometown Shopping Mall this weekend.
- 3) Erica asks every fifth student entering Hometown High School on Monday morning.
- 4) Erica asks every fifth person leaving Saturday's Hometown High School football game.

Integrated Algebra Multiple Choice Regents Exam Questions

www.jmap.org

- 10 The bowling team at Lincoln High School must choose a president, vice president, and secretary. If the team has 10 members, which expression could be used to determine the number of ways the officers could be chosen?
- 1) ${}_3P_{10}$
 - 2) ${}_7P_3$
 - 3) ${}_{10}P_3$
 - 4) ${}_{10}P_7$
- 11 Which equation represents a line that is parallel to the line $y = -4x + 5$?
- 1) $y = -4x + 3$
 - 2) $y = -\frac{1}{4}x + 5$
 - 3) $y = \frac{1}{4}x + 3$
 - 4) $y = 4x + 5$
- 12 The faces of a cube are numbered from 1 to 6. If the cube is tossed once, what is the probability that a prime number or a number divisible by 2 is obtained?
- 1) $\frac{6}{6}$
 - 2) $\frac{5}{6}$
 - 3) $\frac{4}{6}$
 - 4) $\frac{1}{6}$
- 13 In triangle MCT , the measure of $\angle T = 90^\circ$, $MC = 85$ cm, $CT = 84$ cm, and $TM = 13$ cm. Which ratio represents the sine of $\angle C$?
- 1) $\frac{13}{85}$
 - 2) $\frac{84}{85}$
 - 3) $\frac{13}{84}$
 - 4) $\frac{84}{13}$
- 14 The function $y = \frac{x}{x^2 - 9}$ is undefined when the value of x is
- 1) 0 or 3
 - 2) 3 or -3
 - 3) 3, only
 - 4) -3 , only
- 15 If the formula for the perimeter of a rectangle is $P = 2l + 2w$, then w can be expressed as
- 1) $w = \frac{2l - P}{2}$
 - 2) $w = \frac{P - 2l}{2}$
 - 3) $w = \frac{P - l}{2}$
 - 4) $w = \frac{P - 2w}{2l}$
- 16 Which expression is equivalent to $9x^2 - 16$?
- 1) $(3x + 4)(3x - 4)$
 - 2) $(3x - 4)(3x - 4)$
 - 3) $(3x + 8)(3x - 8)$
 - 4) $(3x - 8)(3x - 8)$

Integrated Algebra Multiple Choice Regents Exam Questions

www.jmap.org

- 17 For 10 days, Romero kept a record of the number of hours he spent listening to music. The information is shown in the table below.

Day	1	2	3	4	5	6	7	8	9	10
Hours	9	3	2	6	8	6	10	4	5	2

Which scatter plot shows Romero's data graphically?

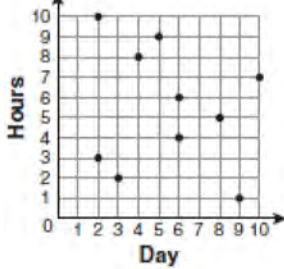

1)

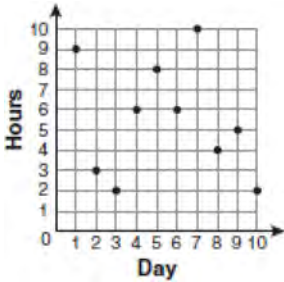

2)

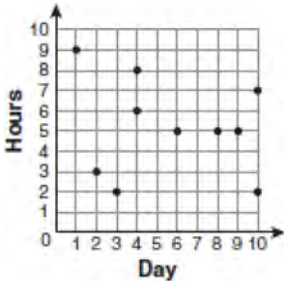

3)

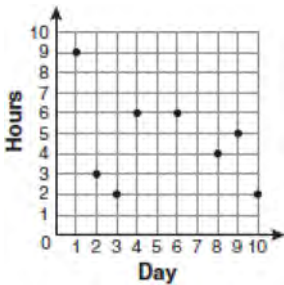

4)

- 18 Luis is going to paint a basketball court on his driveway, as shown in the diagram below. This basketball court consists of a rectangle and a semicircle.

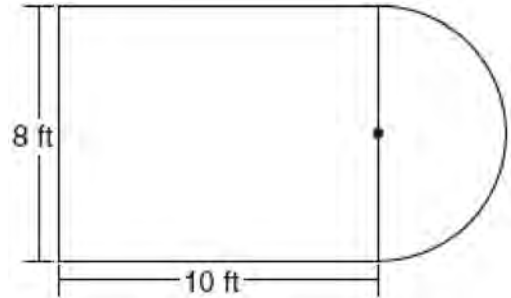

Which expression represents the area of this basketball court, in square feet?

- 1) 80
- 2) $80 + 8\pi$
- 3) $80 + 16\pi$
- 4) $80 + 64\pi$

- 19 Carrie bought new carpet for her living room. She calculated the area of the living room to be 174.2 square feet. The actual area was 149.6 square feet. What is the relative error of the area to the *nearest ten-thousandth*?

- 1) 0.1412
- 2) 0.1644
- 3) 1.8588
- 4) 2.1644

- 20 What is $2\sqrt{45}$ expressed in simplest radical form?

- 1) $3\sqrt{5}$
- 2) $5\sqrt{5}$
- 3) $6\sqrt{5}$
- 4) $18\sqrt{5}$

- 21 Which equation most closely represents the line of best fit for the scatter plot below?

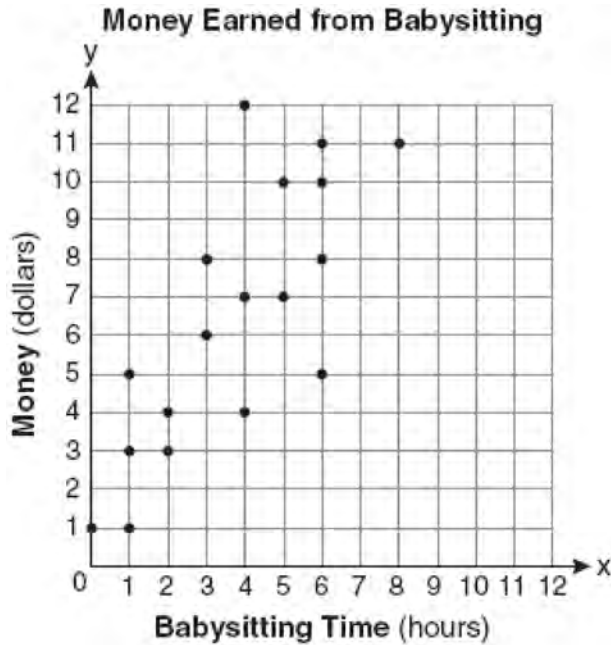

- 1) $y = x$
- 2) $y = \frac{2}{3}x + 1$
- 3) $y = \frac{3}{2}x + 4$
- 4) $y = \frac{3}{2}x + 1$

- 22 If the speed of sound is 344 meters per second, what is the approximate speed of sound, in meters per hour?

60 seconds = 1 minute
60 minutes = 1 hour

- 1) 20,640
- 2) 41,280
- 3) 123,840
- 4) 1,238,400

- 23 Which graph represents a function?

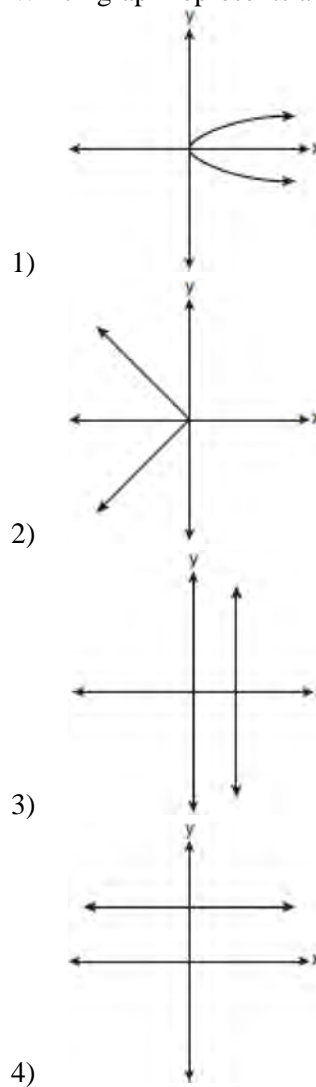

- 24 What is the value of the expression $|-5x + 12|$ when $x = 5$?
- 1) -37
 - 2) -13
 - 3) 13
 - 4) 37

Integrated Algebra Multiple Choice Regents Exam Questions

www.jmap.org

25 If $s = \frac{2x+t}{r}$, then x equals

- 1) $\frac{rs-t}{2}$
- 2) $\frac{rs+1}{2}$
- 3) $2rs-t$
- 4) $rs-2t$

26 Which ordered pair is in the solution set of the system of equations $y = -x + 1$ and $y = x^2 + 5x + 6$?

- 1) $(-5, -1)$
- 2) $(-5, 6)$
- 3) $(5, -4)$
- 4) $(5, 2)$

27 The equations $5x + 2y = 48$ and $3x + 2y = 32$ represent the money collected from school concert ticket sales during two class periods. If x represents the cost for each adult ticket and y represents the cost for each student ticket, what is the cost for each adult ticket?

- 1) \$20
- 2) \$10
- 3) \$8
- 4) \$4

28 Which statement is true about the data set 3, 4, 5, 6, 7, 7, 10?

- 1) mean = mode
- 2) mean > mode
- 3) mean = median
- 4) mean < median

29 An electronics store sells DVD players and cordless telephones. The store makes a \$75 profit on the sale of each DVD player (d) and a \$30 profit on the sale of each cordless telephone (c). The store wants to make a profit of at least \$255.00 from its sales of DVD players and cordless phones. Which inequality describes this situation?

- 1) $75d + 30c < 255$
- 2) $75d + 30c \leq 255$
- 3) $75d + 30c > 255$
- 4) $75d + 30c \geq 255$

30 In the right triangle shown in the diagram below, what is the value of x to the nearest whole number?

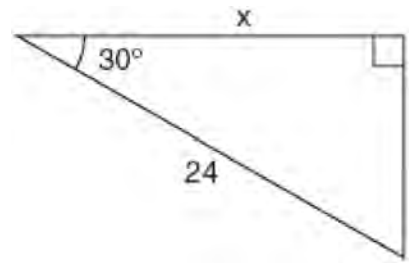

- 1) 12
- 2) 14
- 3) 21
- 4) 28

31 Which expression is equivalent to $64 - x^2$?

- 1) $(8-x)(8-x)$
- 2) $(8-x)(8+x)$
- 3) $(x-8)(x-8)$
- 4) $(x-8)(x+8)$

Integrated Algebra Multiple Choice Regents Exam Questions

www.jmap.org

- 32 Tanya runs diagonally across a rectangular field that has a length of 40 yards and a width of 30 yards, as shown in the diagram below.

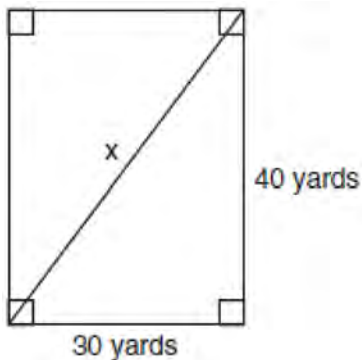

What is the length of the diagonal, in yards, that Tanya runs?

- 1) 50
2) 60
3) 70
4) 80
- 33 Which expression represents $\frac{25x - 125}{x^2 - 25}$ in simplest form?
- 1) $\frac{5}{x}$
2) $\frac{-5}{x}$
3) $\frac{25}{x - 5}$
4) $\frac{25}{x + 5}$

- 34 The length of the hypotenuse of a right triangle is 34 inches and the length of one of its legs is 16 inches. What is the length, in inches, of the other leg of this right triangle?

- 1) 16
2) 18
3) 25
4) 30

- 35 Which relationship can best be described as causal?

- 1) height and intelligence
2) shoe size and running speed
3) number of correct answers on a test and test score
4) number of students in a class and number of students with brown hair

- 36 Marie currently has a collection of 58 stamps. If she buys s stamps each week for w weeks, which expression represents the total number of stamps she will have?

- 1) $58sw$
2) $58 + sw$
3) $58s + w$
4) $58 + s + w$

- 37 Which value of p is the solution of $5p - 1 = 2p + 20$?

- 1) $\frac{19}{7}$
2) $\frac{19}{3}$
3) 3
4) 7

Integrated Algebra Multiple Choice Regents Exam Questions

www.jmap.org

38 Which interval notation represents the set of all numbers from 2 through 7, inclusive?

- 1) $(2,7)$
- 2) $(2,7)$
- 3) $[2,7)$
- 4) $[2,7]$

39 What is the slope of the line that passes through the points $(2,5)$ and $(7,3)$?

- 1) $-\frac{5}{2}$
- 2) $-\frac{2}{5}$
- 3) $\frac{8}{9}$
- 4) $\frac{9}{8}$

40 A rectangle has an area of 24 square units. The width is 5 units less than the length. What is the length, in units, of the rectangle?

- 1) 6
- 2) 8
- 3) 3
- 4) 19

41 What are the vertex and axis of symmetry of the parabola $y = x^2 - 16x + 63$?

- 1) vertex: $(8,-1)$; axis of symmetry: $x = 8$
- 2) vertex: $(8,1)$; axis of symmetry: $x = 8$
- 3) vertex: $(-8,-1)$; axis of symmetry: $x = -8$
- 4) vertex: $(-8,1)$; axis of symmetry: $x = -8$

42 The diagram below shows right triangle UPC .

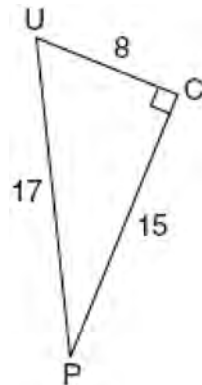

Which ratio represents the sine of $\angle U$?

- 1) $\frac{15}{8}$
- 2) $\frac{15}{17}$
- 3) $\frac{8}{15}$
- 4) $\frac{8}{17}$

43 Solve for x : $\frac{3}{5}(x+2) = x-4$

- 1) 8
- 2) 13
- 3) 15
- 4) 23

44 What is the product of $-3x^2y$ and $(5xy^2 + xy)$?

- 1) $-15x^3y^3 - 3x^3y^2$
- 2) $-15x^3y^3 - 3x^3y$
- 3) $-15x^2y^2 - 3x^2y$
- 4) $-15x^3y^3 + xy$

Integrated Algebra Multiple Choice Regents Exam Questions

www.jmap.org

- 45 Cassandra bought an antique dresser for \$500. If the value of her dresser increases 6% annually, what will be the value of Cassandra's dresser at the end of 3 years to the *nearest dollar*?
- 1) \$415
 - 2) \$590
 - 3) \$596
 - 4) \$770

- 49 Nicole's aerobics class exercises to fast-paced music. If the rate of the music is 120 beats per minute, how many beats would there be in a class that is 0.75 hour long?
- 1) 90
 - 2) 160
 - 3) 5,400
 - 4) 7,200

- 46 The sum of two numbers is 47, and their difference is 15. What is the larger number?
- 1) 16
 - 2) 31
 - 3) 32
 - 4) 36

- 50 What is half of 2^6 ?
- 1) 1^3
 - 2) 1^6
 - 3) 2^3
 - 4) 2^5

- 47 The statement $2 + 0 = 2$ is an example of the use of which property of real numbers?
- 1) associative
 - 2) additive identity
 - 3) additive inverse
 - 4) distributive

- 51 The spinner below is divided into eight equal regions and is spun once. What is the probability of *not* getting red?

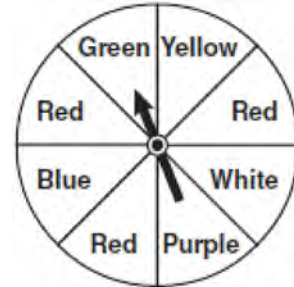

- 48 Which ordered pair is a solution to the system of equations $y = x$ and $y = x^2 - 2$?
- 1) $(-2, -2)$
 - 2) $(-1, 1)$
 - 3) $(0, 0)$
 - 4) $(2, 2)$

- 1) $\frac{3}{5}$
- 2) $\frac{3}{8}$
- 3) $\frac{5}{8}$
- 4) $\frac{7}{8}$

Integrated Algebra Multiple Choice Regents Exam Questions

www.jmap.org

52 What is an equation of the line that passes through the point $(3, -1)$ and has a slope of 2?

- 1) $y = 2x + 5$
- 2) $y = 2x - 1$
- 3) $y = 2x - 4$
- 4) $y = 2x - 7$

53 Which equation represents a line parallel to the x -axis?

- 1) $y = -5$
- 2) $y = -5x$
- 3) $x = 3$
- 4) $x = 3y$

54 Which situation describes a correlation that is *not* a causal relationship?

- 1) The rooster crows, and the Sun rises.
- 2) The more miles driven, the more gasoline needed
- 3) The more powerful the microwave, the faster the food cooks.
- 4) The faster the pace of a runner, the quicker the runner finishes.

55 Which expression represents $\frac{x^2 - 2x - 15}{x^2 + 3x}$ in simplest form?

- 1) -5
- 2) $\frac{x - 5}{x}$
- 3) $\frac{-2x - 5}{x}$
- 4) $\frac{-2x - 15}{3x}$

56 Which graph represents a linear function?

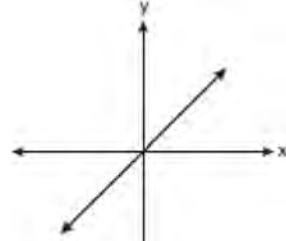

1)

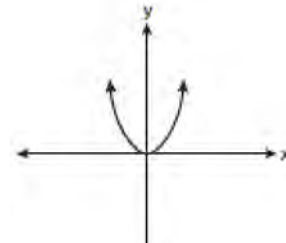

2)

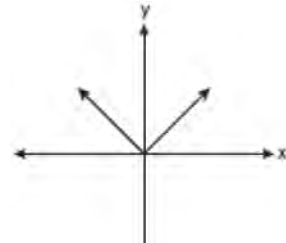

3)

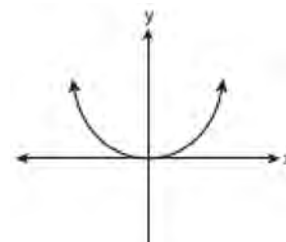

4)

57 Which verbal expression represents $2(n - 6)$?

- 1) two times n minus six
- 2) two times six minus n
- 3) two times the quantity n less than six
- 4) two times the quantity six less than n

Integrated Algebra Multiple Choice Regents Exam Questions

www.jmap.org

58 Which graph represents the inequality $y > 3$?

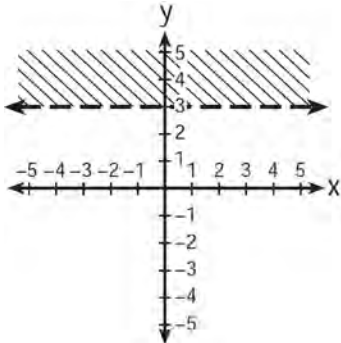

1)

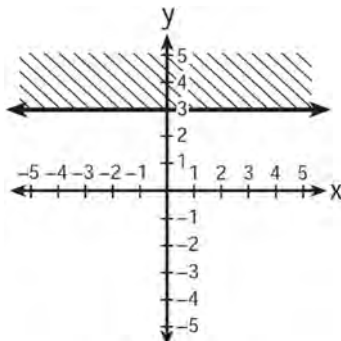

2)

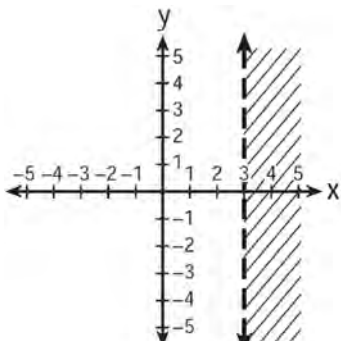

3)

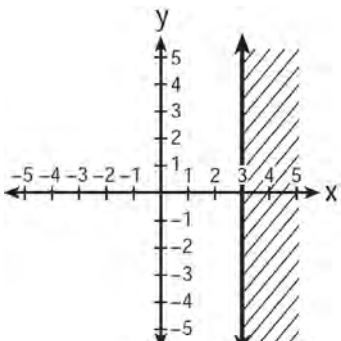

4)

59 What is $\frac{\sqrt{32}}{4}$ expressed in simplest radical form?

- 1) $\sqrt{2}$
- 2) $4\sqrt{2}$
- 3) $\sqrt{8}$
- 4) $\frac{\sqrt{8}}{2}$

60 What is $\frac{6}{4a} - \frac{2}{3a}$ expressed in simplest form?

- 1) $\frac{4}{a}$
- 2) $\frac{5}{6a}$
- 3) $\frac{8}{7a}$
- 4) $\frac{10}{12a}$

61 The roots of the equation $3x^2 - 27x = 0$ are

- 1) 0 and 9
- 2) 0 and -9
- 3) 0 and 3
- 4) 0 and -3

62 What is the solution of $\frac{k+4}{2} = \frac{k+9}{3}$?

- 1) 1
- 2) 5
- 3) 6
- 4) 14

Integrated Algebra Multiple Choice Regents Exam Questions

www.jmap.org

- 63 In the diagram below, circle O is inscribed in square $ABCD$. The square has an area of 36.

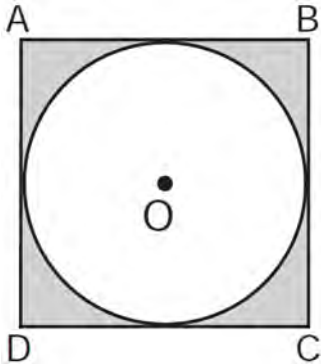

What is the area of the circle?

- 1) 9π
 - 2) 6π
 - 3) 3π
 - 4) 36π
- 64 What is the value of the y -coordinate of the solution to the system of equations $x + 2y = 9$ and $x - y = 3$?
- 1) 6
 - 2) 2
 - 3) 3
 - 4) 5

- 65 The expression $\frac{(4x^3)^2}{2x}$ is equivalent to

- 1) $4x^4$
- 2) $4x^5$
- 3) $8x^4$
- 4) $8x^5$

- 66 A school wants to add a coed soccer program. To determine student interest in the program, a survey will be taken. In order to get an unbiased sample, which group should the school survey?
- 1) every third student entering the building
 - 2) every member of the varsity football team
 - 3) every member in Ms. Zimmer's drama classes
 - 4) every student having a second-period French class

- 67 The New York Volleyball Association invited 64 teams to compete in a tournament. After each round, half of the teams were eliminated. Which equation represents the number of teams, t , that remained in the tournament after r rounds?

- 1) $t = 64(r)^{0.5}$
- 2) $t = 64(-0.5)^r$
- 3) $t = 64(1.5)^r$
- 4) $t = 64(0.5)^r$

- 68 Jack bought 3 slices of cheese pizza and 4 slices of mushroom pizza for a total cost of \$12.50. Grace bought 3 slices of cheese pizza and 2 slices of mushroom pizza for a total cost of \$8.50. What is the cost of one slice of mushroom pizza?
- 1) \$1.50
 - 2) \$2.00
 - 3) \$3.00
 - 4) \$3.50

- 69 The faces of a cube are numbered from 1 to 6. If the cube is rolled once, which outcome is *least* likely to occur?
- 1) rolling an odd number
 - 2) rolling an even number
 - 3) rolling a number less than 6
 - 4) rolling a number greater than 4

Integrated Algebra Multiple Choice Regents Exam Questions

www.jmap.org

70 The groundskeeper is replacing the turf on a football field. His measurements of the field are 130 yards by 60 yards. The actual measurements are 120 yards by 54 yards. Which expression represents the relative error in the measurement?

- 1) $\frac{(130)(60) - (120)(54)}{(120)(54)}$
- 2) $\frac{(120)(54)}{(130)(60) - (120)(54)}$
- 3) $\frac{(130)(60) - (120)(54)}{(130)(60)}$
- 4) $\frac{(130)(60)}{(130)(60) - (120)(54)}$

71 Byron is 3 years older than Doug. The product of their ages is 40. How old is Doug?

- 1) 10
- 2) 8
- 3) 5
- 4) 4

72 For which values of x is the fraction $\frac{x^2 + x - 6}{x^2 + 5x - 6}$ undefined?

- 1) 1 and -6
- 2) 2 and -3
- 3) 3 and -2
- 4) 6 and -1

73 When $4x^2 + 7x - 5$ is subtracted from $9x^2 - 2x + 3$, the result is

- 1) $5x^2 + 5x - 2$
- 2) $5x^2 - 9x + 8$
- 3) $-5x^2 + 5x - 2$
- 4) $-5x^2 + 9x - 8$

74 Which graph represents the solution of $3y - 9 \leq 6x$?

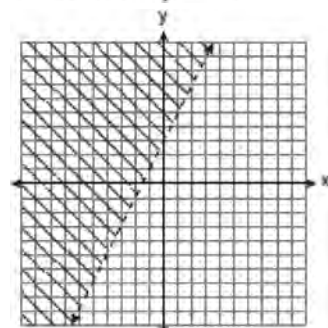
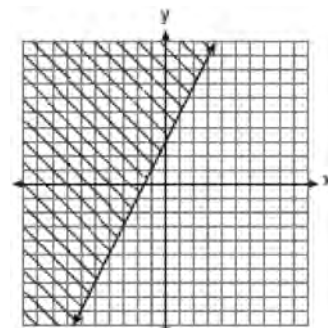
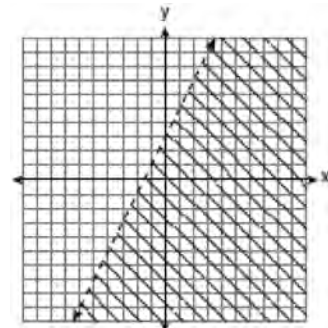
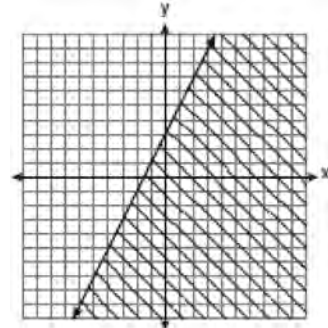

Integrated Algebra Multiple Choice Regents Exam Questions

www.jmap.org

- 75 Which equation could be used to find the measure of one acute angle in the right triangle shown below?

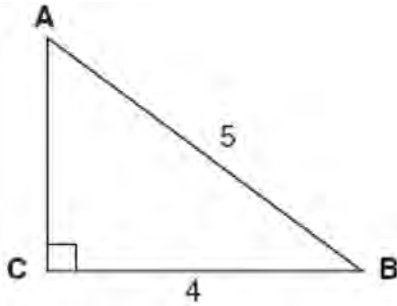

- 1) $\sin A = \frac{4}{5}$
 - 2) $\tan A = \frac{5}{4}$
 - 3) $\cos B = \frac{5}{4}$
 - 4) $\tan B = \frac{4}{5}$
- 76 Consider the graph of the equation $y = ax^2 + bx + c$, when $a \neq 0$. If a is multiplied by 3, what is true of the graph of the resulting parabola?
- 1) The vertex is 3 units above the vertex of the original parabola.
 - 2) The new parabola is 3 units to the right of the original parabola.
 - 3) The new parabola is wider than the original parabola.
 - 4) The new parabola is narrower than the original parabola.

- 77 Which value of x is in the solution set of the inequality $-4x + 2 > 10$?

- 1) -2
- 2) 2
- 3) 3
- 4) -4

- 78 Which expression represents $\frac{27x^{18}y^5}{9x^6y}$ in simplest form?

- 1) $3x^{12}y^4$
- 2) $3x^3y^5$
- 3) $18x^{12}y^4$
- 4) $18x^3y^5$

- 79 If $a + ar = b + r$, the value of a in terms of b and r can be expressed as

- 1) $\frac{b}{r} + 1$
- 2) $\frac{1+b}{r}$
- 3) $\frac{b+r}{1+r}$
- 4) $\frac{1+b}{r+b}$

- 80 Which data set describes a situation that could be classified as qualitative?

- 1) the ages of the students in Ms. Marshall's Spanish class
- 2) the test scores of the students in Ms. Fitzgerald's class
- 3) the favorite ice cream flavor of each of Mr. Hayden's students
- 4) the heights of the players on the East High School basketball team

Integrated Algebra Multiple Choice Regents Exam Questions

www.jmap.org

81 What is $\frac{6}{5x} - \frac{2}{3x}$ in simplest form?

- 1) $\frac{8}{15x^2}$
- 2) $\frac{8}{15x}$
- 3) $\frac{4}{15x}$
- 4) $\frac{4}{2x}$

82 Which equation represents the axis of symmetry of the graph of the parabola below?

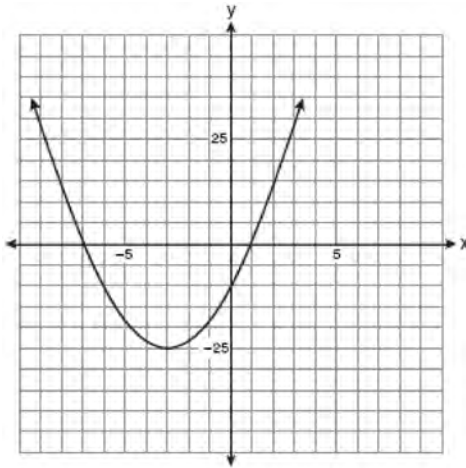

- 1) $y = -3$
- 2) $x = -3$
- 3) $y = -25$
- 4) $x = -25$

83 What is $\sqrt{32}$ expressed in simplest radical form?

- 1) $16\sqrt{2}$
- 2) $4\sqrt{2}$
- 3) $4\sqrt{8}$
- 4) $2\sqrt{8}$

84 John is going to line up his four golf trophies on a shelf in his bedroom. How many different possible arrangements can he make?

- 1) 24
- 2) 16
- 3) 10
- 4) 4

85 What is the slope of the line that passes through the points $(-6, 1)$ and $(4, -4)$?

- 1) -2
- 2) 2
- 3) $-\frac{1}{2}$
- 4) $\frac{1}{2}$

86 What is the value of the third quartile shown on the box-and-whisker plot below?

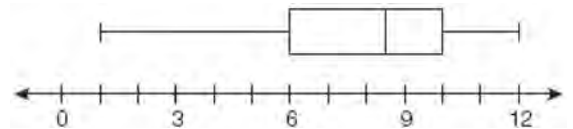

- 1) 6
- 2) 8.5
- 3) 10
- 4) 12

87 What is the value of the y -coordinate of the solution to the system of equations $x - 2y = 1$ and $x + 4y = 7$?

- 1) 1
- 2) -1
- 3) 3
- 4) 4

Integrated Algebra Multiple Choice Regents Exam Questions

www.jmap.org

88 Throughout history, many people have contributed to the development of mathematics. These mathematicians include Pythagoras, Euclid, Hypatia, Euler, Einstein, Agnesi, Fibonacci, and Pascal. What is the probability that a mathematician's name selected at random from those listed will start with either the letter *E* or the letter *A*?

- 1) $\frac{2}{8}$
- 2) $\frac{3}{8}$
- 3) $\frac{4}{8}$
- 4) $\frac{6}{8}$

89 A spinner is divided into eight equal regions as shown in the diagram below.

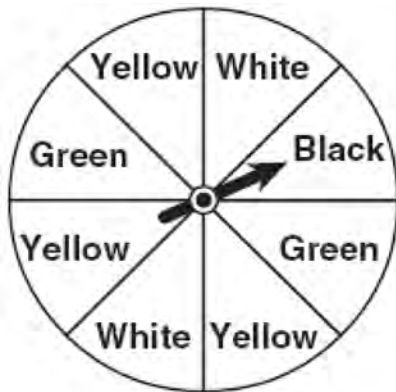

- Which event is most likely to occur in one spin?
- 1) The arrow will land in a green or white area.
 - 2) The arrow will land in a green or black area.
 - 3) The arrow will land in a yellow or black area.
 - 4) The arrow will land in a yellow or green area.

90 The box-and-whisker plot below represents students' scores on a recent English test.

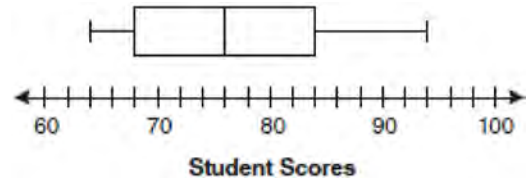

What is the value of the upper quartile?

- 1) 68
- 2) 76
- 3) 84
- 4) 94

91 Which ordered pair is a solution of the system of equations $y = x^2 - x - 20$ and $y = 3x - 15$?

- 1) $(-5, -30)$
- 2) $(-1, -18)$
- 3) $(0, 5)$
- 4) $(5, -1)$

92 Given:

$A = \{ \text{All even integers from 2 to 20, inclusive} \}$

$B = \{ 10, 12, 14, 16, 18 \}$

What is the complement of set *B* within the universe of set *A*?

- 1) $\{ 4, 6, 8 \}$
- 2) $\{ 2, 4, 6, 8 \}$
- 3) $\{ 4, 6, 8, 20 \}$
- 4) $\{ 2, 4, 6, 8, 20 \}$

Integrated Algebra Multiple Choice Regents Exam Questions

www.jmap.org

93 What is an equation of the line that passes through the points $(3, -3)$ and $(-3, -3)$?

- 1) $y = 3$
- 2) $x = -3$
- 3) $y = -3$
- 4) $x = y$

94 What is $\sqrt{72}$ expressed in simplest radical form?

- 1) $2\sqrt{18}$
- 2) $3\sqrt{8}$
- 3) $6\sqrt{2}$
- 4) $8\sqrt{3}$

95 To calculate the volume of a small wooden cube, Ezra measured an edge of the cube as 2 cm. The actual length of the edge of Ezra's cube is 2.1 cm. What is the relative error in his volume calculation to the nearest hundredth?

- 1) 0.13
- 2) 0.14
- 3) 0.15
- 4) 0.16

96 Which expression represents $(3x^2y^4)(4xy^2)$ in simplest form?

- 1) $12x^2y^8$
- 2) $12x^2y^6$
- 3) $12x^3y^8$
- 4) $12x^3y^6$

97 The equation $y = x^2 + 3x - 18$ is graphed on the set of axes below.

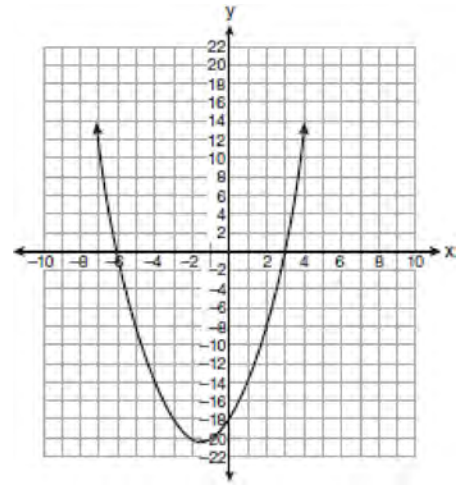

Based on this graph, what are the roots of the equation $x^2 + 3x - 18 = 0$?

- 1) -3 and 6
- 2) 0 and -18
- 3) 3 and -6
- 4) 3 and -18

98 It takes Tammy 45 minutes to ride her bike 5 miles. At this rate, how long will it take her to ride 8 miles?

- 1) 0.89 hour
- 2) 1.125 hours
- 3) 48 minutes
- 4) 72 minutes

99 What is an equation of the line that passes through the point $(4, -6)$ and has a slope of -3 ?

- 1) $y = -3x + 6$
- 2) $y = -3x - 6$
- 3) $y = -3x + 10$
- 4) $y = -3x + 14$

Integrated Algebra Multiple Choice Regents Exam Questions

www.jmap.org

- 100 The solution to the equation $x^2 - 6x = 0$ is
- 1) 0, only
 - 2) 6, only
 - 3) 0 and 6
 - 4) $\pm\sqrt{6}$
- 101 Which ordered pair is in the solution set of the following system of inequalities?
- $$y < \frac{1}{2}x + 4$$
- $$y \geq -x + 1$$
- 1) (-5, 3)
 - 2) (0, 4)
 - 3) (3, -5)
 - 4) (4, 0)
- 102 What is the product of $\frac{4x}{x-1}$ and $\frac{x^2-1}{3x+3}$ expressed in simplest form?
- 1) $\frac{4x}{3}$
 - 2) $\frac{4x^2}{3}$
 - 3) $\frac{4x^2}{3(x+1)}$
 - 4) $\frac{4(x+1)}{3}$
- 103 Daniel's Print Shop purchased a new printer for \$35,000. Each year it depreciates (loses value) at a rate of 5%. What will its approximate value be at the end of the fourth year?
- 1) \$33,250.00
 - 2) \$30,008.13
 - 3) \$28,507.72
 - 4) \$27,082.33
- 104 The local ice cream stand offers three flavors of soft-serve ice cream: vanilla, chocolate, and strawberry; two types of cone: sugar and wafer; and three toppings: sprinkles, nuts, and cookie crumbs. If Dawn does not order vanilla ice cream, how many different choices can she make that have one flavor of ice cream, one type of cone, and one topping?
- 1) 7
 - 2) 8
 - 3) 12
 - 4) 18
- 105 Timmy bought a skateboard and two helmets for a total of d dollars. If each helmet cost h dollars, the cost of the skateboard could be represented by
- 1) $2dh$
 - 2) $\frac{dh}{2}$
 - 3) $d - 2h$
 - 4) $d - \frac{h}{2}$
- 106 Which value of x is the solution of $\frac{2x}{5} + \frac{1}{3} = \frac{7x-2}{15}$?
- 1) $\frac{3}{5}$
 - 2) $\frac{31}{26}$
 - 3) 3
 - 4) 7

Integrated Algebra Multiple Choice Regents Exam Questions

www.jmap.org

- 107 Two equations were graphed on the set of axes below.

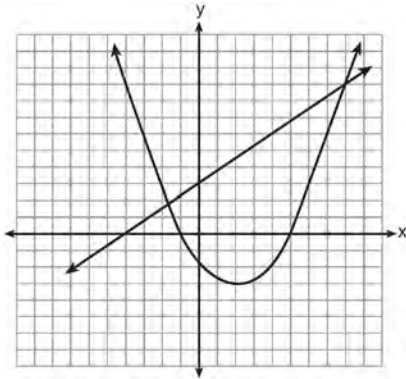

Which point is a solution of the system of equations shown on the graph?

- 1) (8, 9)
 - 2) (5, 0)
 - 3) (0, 3)
 - 4) (2, -3)
- 108 Which value of x is the solution of the equation

$$\frac{2x}{3} + \frac{x}{6} = 5?$$

- 1) 6
 - 2) 10
 - 3) 15
 - 4) 30
- 109 Factored, the expression $16x^2 - 25y^2$ is equivalent to

- 1) $(4x - 5y)(4x + 5y)$
- 2) $(4x - 5y)(4x - 5y)$
- 3) $(8x - 5y)(8x + 5y)$
- 4) $(8x - 5y)(8x - 5y)$

- 110 Campsite A and campsite B are located directly opposite each other on the shores of Lake Omega, as shown in the diagram below. The two campsites form a right triangle with Sam's position, S . The distance from campsite B to Sam's position is 1,300 yards, and campsite A is 1,700 yards from his position.

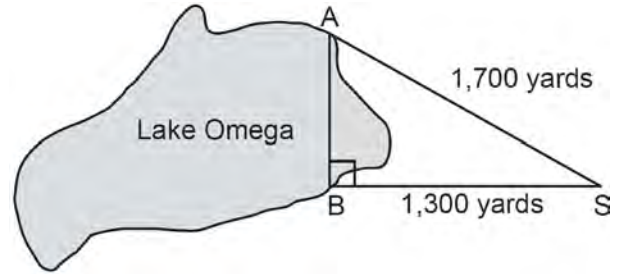

What is the distance from campsite A to campsite B , to the nearest yard?

- 1) 1,095
 - 2) 1,096
 - 3) 2,140
 - 4) 2,141
- 111 Which data set describes a situation that could be classified as qualitative?
- 1) the elevations of the five highest mountains in the world
 - 2) the ages of presidents at the time of their inauguration
 - 3) the opinions of students regarding school lunches
 - 4) the shoe sizes of players on the basketball team

Integrated Algebra Multiple Choice Regents Exam Questions

www.jmap.org

- 112 In a linear equation, the independent variable increases at a constant rate while the dependent variable decreases at a constant rate. The slope of this line is
- 1) zero
 - 2) negative
 - 3) positive
 - 4) undefined

- 113 The diagram below shows right triangle LMP .

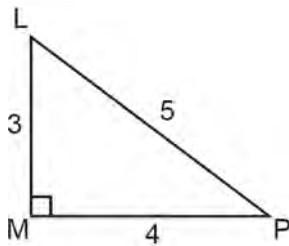

Which ratio represents the tangent of $\angle PLM$?

- 1) $\frac{3}{4}$
 - 2) $\frac{3}{5}$
 - 3) $\frac{4}{3}$
 - 4) $\frac{5}{4}$
- 114 What is the product of 12 and 4.2×10^6 expressed in scientific notation?
- 1) 50.4×10^6
 - 2) 50.4×10^7
 - 3) 5.04×10^6
 - 4) 5.04×10^7

- 115 The gas tank in a car holds a total of 16 gallons of gas. The car travels 75 miles on 4 gallons of gas. If the gas tank is full at the beginning of a trip, which graph represents the rate of change in the amount of gas in the tank?

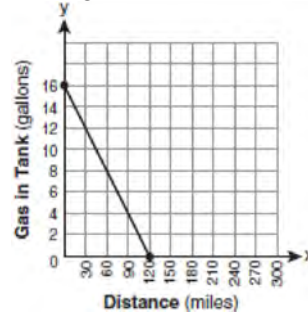

1)

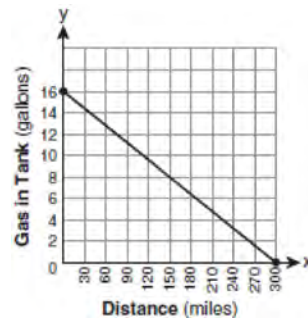

2)

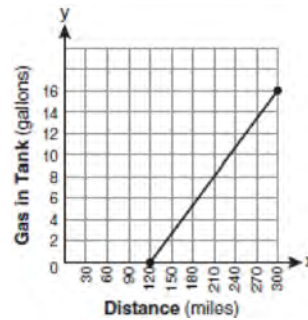

3)

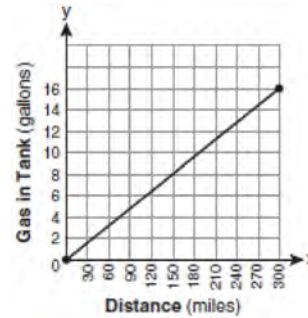

4)

Integrated Algebra Multiple Choice Regents Exam Questions

www.jmap.org

- 116 Three fair coins are tossed. What is the probability that two heads and one tail appear?
- 1) $\frac{1}{8}$
 - 2) $\frac{3}{8}$
 - 3) $\frac{3}{6}$
 - 4) $\frac{2}{3}$
- 117 The set $\{1,2,3,4\}$ is equivalent to
- 1) $\{x \mid 1 < x < 4, \text{ where } x \text{ is a whole number}\}$
 - 2) $\{x \mid 0 < x < 4, \text{ where } x \text{ is a whole number}\}$
 - 3) $\{x \mid 0 < x \leq 4, \text{ where } x \text{ is a whole number}\}$
 - 4) $\{x \mid 1 < x \leq 4, \text{ where } x \text{ is a whole number}\}$
- 118 When $5\sqrt{20}$ is written in simplest radical form, the result is $k\sqrt{5}$. What is the value of k ?
- 1) 20
 - 2) 10
 - 3) 7
 - 4) 4
- 119 Which equation is an example of the use of the associative property of addition?
- 1) $x + 7 = 7 + x$
 - 2) $3(x + y) = 3x + 3y$
 - 3) $(x + y) + 3 = x + (y + 3)$
 - 4) $3 + (x + y) = (x + y) + 3$
- 120 When $3g^2 - 4g + 2$ is subtracted from $7g^2 + 5g - 1$, the difference is
- 1) $-4g^2 - 9g + 3$
 - 2) $4g^2 + g + 1$
 - 3) $4g^2 + 9g - 3$
 - 4) $10g^2 + g + 1$
- 121 Students in a ninth grade class measured their heights, h , in centimeters. The height of the shortest student was 155 cm, and the height of the tallest student was 190 cm. Which inequality represents the range of heights?
- 1) $155 < h < 190$
 - 2) $155 \leq h \leq 190$
 - 3) $h \geq 155$ or $h \leq 190$
 - 4) $h > 155$ or $h < 190$
- 122 What are the roots of the equation $x^2 - 7x + 6 = 0$?
- 1) 1 and 7
 - 2) -1 and 7
 - 3) -1 and -6
 - 4) 1 and 6
- 123 What is the sum of $\frac{3}{2x}$ and $\frac{4}{3x}$ expressed in simplest form?
- 1) $\frac{12}{6x^2}$
 - 2) $\frac{17}{6x}$
 - 3) $\frac{7}{5x}$
 - 4) $\frac{17}{12x}$

Integrated Algebra Multiple Choice Regents Exam Questions

www.jmap.org

- 124 Keisha is playing a game using a wheel divided into eight equal sectors, as shown in the diagram below. Each time the spinner lands on orange, she will win a prize.

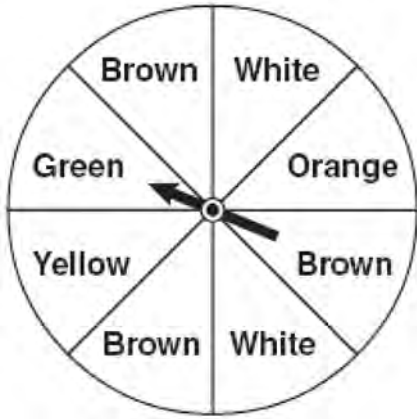

If Keisha spins this wheel twice, what is the probability she will win a prize on *both* spins?

- 1) $\frac{1}{64}$
 - 2) $\frac{1}{56}$
 - 3) $\frac{1}{16}$
 - 4) $\frac{1}{4}$
- 125 At Genesee High School, the sophomore class has 60 more students than the freshman class. The junior class has 50 fewer students than twice the students in the freshman class. The senior class is three times as large as the freshman class. If there are a total of 1,424 students at Genesee High School, how many students are in the freshman class?
- 1) 202
 - 2) 205
 - 3) 235
 - 4) 236

- 126 The equation of the axis of symmetry of the graph of $y = 2x^2 - 3x + 7$ is

- 1) $x = \frac{3}{4}$
- 2) $y = \frac{3}{4}$
- 3) $x = \frac{3}{2}$
- 4) $y = \frac{3}{2}$

- 127 Don placed a ladder against the side of his house as shown in the diagram below.

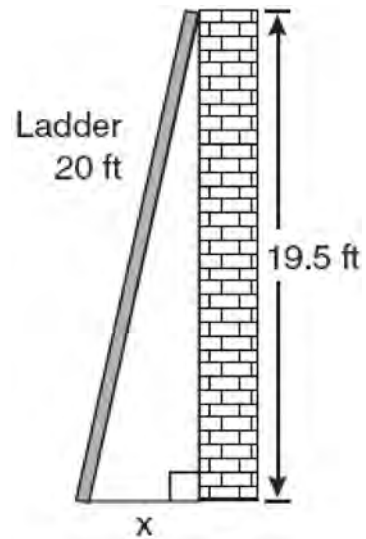

Which equation could be used to find the distance, x , from the foot of the ladder to the base of the house?

- 1) $x = 20 - 19.5$
- 2) $x = 20^2 - 19.5^2$
- 3) $x = \sqrt{20^2 - 19.5^2}$
- 4) $x = \sqrt{20^2 + 19.5^2}$

Integrated Algebra Multiple Choice Regents Exam Questions

www.jmap.org

128 Which graph represents a function?

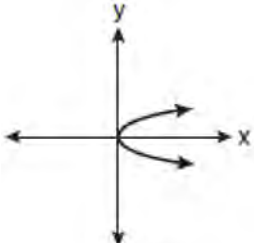
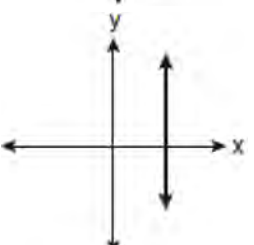
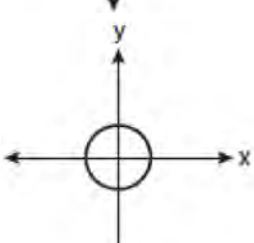
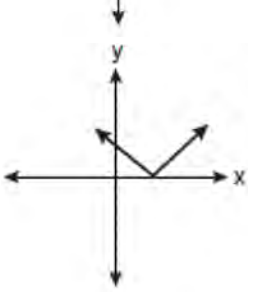
- 1) 
- 2) 
- 3) 
- 4) 

129 On a certain day in Toronto, Canada, the temperature was 15° Celsius (C). Using the formula $F = \frac{9}{5}C + 32$, Peter converts this temperature to degrees Fahrenheit (F). Which temperature represents 15° C in degrees Fahrenheit?

- 1) -9
 2) 35
 3) 59
 4) 85

130 What is the quotient of 8.05×10^6 and 3.5×10^2 ?

- 1) 2.3×10^3
 2) 2.3×10^4
 3) 2.3×10^8
 4) 2.3×10^{12}

131 There is a negative correlation between the number of hours a student watches television and his or her social studies test score. Which scatter plot below displays this correlation?

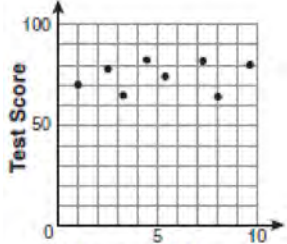
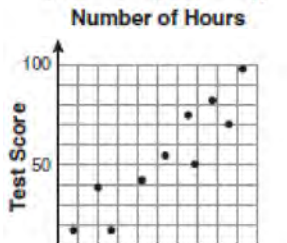
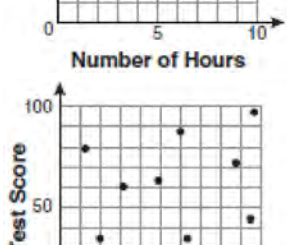
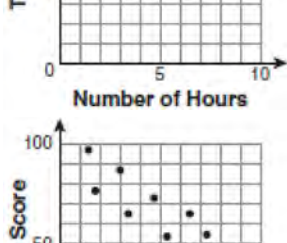
- 1) 
- 2) 
- 3) 
- 4) 

Integrated Algebra Multiple Choice Regents Exam Questions

www.jmap.org

132 The expression $x^2 - 16$ is equivalent to

- 1) $(x + 2)(x - 8)$
- 2) $(x - 2)(x + 8)$
- 3) $(x + 4)(x - 4)$
- 4) $(x + 8)(x - 8)$

133 The sign shown below is posted in front of a roller coaster ride at the Wadsworth County Fairgrounds.

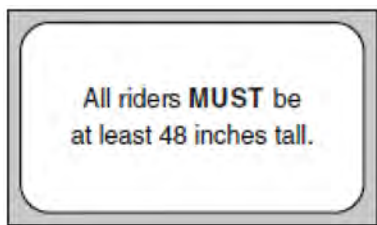

If h represents the height of a rider in inches, what is a correct translation of the statement on this sign?

- 1) $h < 48$
- 2) $h > 48$
- 3) $h \leq 48$
- 4) $h \geq 48$

134 Factored completely, the expression $2x^2 + 10x - 12$ is equivalent to

- 1) $2(x - 6)(x + 1)$
- 2) $2(x + 6)(x - 1)$
- 3) $2(x + 2)(x + 3)$
- 4) $2(x - 2)(x - 3)$

135 What is the product of 8.4×10^8 and 4.2×10^3 written in scientific notation?

- 1) 2.0×10^5
- 2) 12.6×10^{11}
- 3) 35.28×10^{11}
- 4) 3.528×10^{12}

136 What is the value of x in the equation $\frac{2}{x} - 3 = \frac{26}{x}$?

- 1) -8
- 2) $-\frac{1}{8}$
- 3) $\frac{1}{8}$
- 4) 8

137 Lenny made a cube in technology class. Each edge measured 1.5 cm. What is the volume of the cube in cubic centimeters?

- 1) 2.25
- 2) 3.375
- 3) 9.0
- 4) 13.5

138 Which value of x makes the expression

$$\frac{x^2 - 9}{x^2 + 7x + 10} \text{ undefined?}$$

- 1) -5
- 2) 2
- 3) 3
- 4) -3

Integrated Algebra Multiple Choice Regents Exam Questions

www.jmap.org

- 139 The length of a rectangular window is 5 feet more than its width, w . The area of the window is 36 square feet. Which equation could be used to find the dimensions of the window?

- 1) $w^2 + 5w + 36 = 0$
- 2) $w^2 - 5w - 36 = 0$
- 3) $w^2 - 5w + 36 = 0$
- 4) $w^2 + 5w - 36 = 0$

- 140 What are the vertex and the axis of symmetry of the parabola shown in the diagram below?

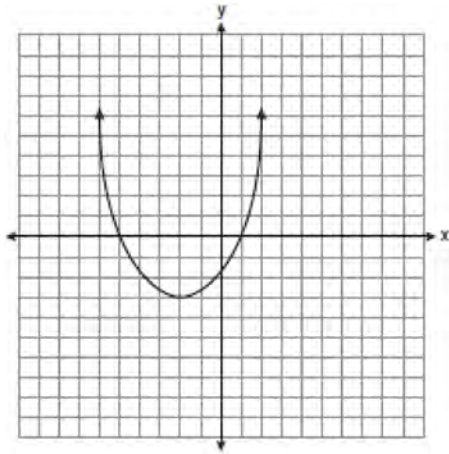

- 1) The vertex is $(-2, -3)$, and the axis of symmetry is $x = -2$.
- 2) The vertex is $(-2, -3)$, and the axis of symmetry is $y = -2$.
- 3) The vertex is $(-3, -2)$, and the axis of symmetry is $y = -2$.
- 4) The vertex is $(-3, -2)$, and the axis of symmetry is $x = -2$.

- 141 Mr. Stanton asked his students to write an algebraic expression on a piece of paper. He chose four students to go to the board and write their expression.

Robert wrote: $4(2x + 5) \geq 17$

Meredith wrote: $3y - 7 + 11z$

Steven wrote: $9w + 2 = 20$

Cynthia wrote: $8 + 10 - 4 = 14$

Which student wrote an algebraic expression?

- 1) Robert
- 2) Meredith
- 3) Steven
- 4) Cynthia

- 142 What is the slope of the line containing the points $(3, 4)$ and $(-6, 10)$?

- 1) $\frac{1}{2}$
- 2) 2
- 3) $-\frac{2}{3}$
- 4) $-\frac{3}{2}$

- 143 Mr. Turner bought x boxes of pencils. Each box holds 25 pencils. He left 3 boxes of pencils at home and took the rest to school. Which expression represents the total number of pencils he took to school?

- 1) $22x$
- 2) $25x - 3$
- 3) $25 - 3x$
- 4) $25x - 75$

Integrated Algebra Multiple Choice Regents Exam Questions

www.jmap.org

- 144 A scatter plot was constructed on the graph below and a line of best fit was drawn.

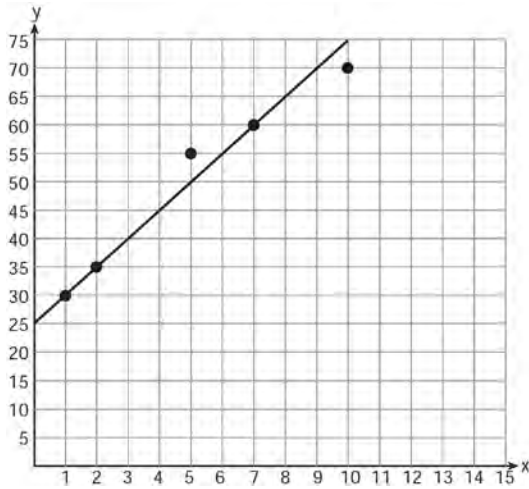

What is the equation of this line of best fit?

- 1) $y = x + 5$
 - 2) $y = x + 25$
 - 3) $y = 5x + 5$
 - 4) $y = 5x + 25$
- 145 The ages of three brothers are consecutive even integers. Three times the age of the youngest brother exceeds the oldest brother's age by 48 years. What is the age of the youngest brother?
- 1) 14
 - 2) 18
 - 3) 22
 - 4) 26

- 146 A tree casts a 25-foot shadow on a sunny day, as shown in the diagram below.

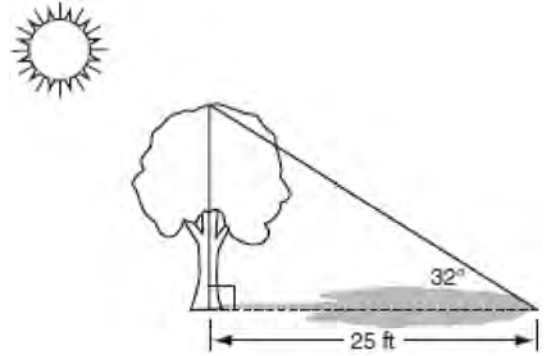

If the angle of elevation from the tip of the shadow to the top of the tree is 32° , what is the height of the tree to the nearest tenth of a foot?

- 1) 13.2
 - 2) 15.6
 - 3) 21.2
 - 4) 40.0
- 147 The actual dimensions of a rectangle are 2.6 cm by 6.9 cm. Andy measures the sides as 2.5 cm by 6.8 cm. In calculating the area, what is the relative error, to the nearest thousandth?
- 1) 0.055
 - 2) 0.052
 - 3) 0.022
 - 4) 0.021
- 148 What is the sum of $-3x^2 - 7x + 9$ and $-5x^2 + 6x - 4$?
- 1) $-8x^2 - x + 5$
 - 2) $-8x^4 - x + 5$
 - 3) $-8x^2 - 13x + 13$
 - 4) $-8x^4 - 13x^2 + 13$

Integrated Algebra Multiple Choice Regents Exam Questions

www.jmap.org

- 149 Which statement is true about the relation shown on the graph below?

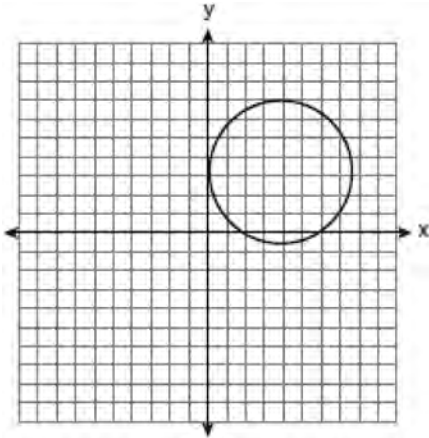

- 1) It is a function because there exists one x -coordinate for each y -coordinate.
- 2) It is a function because there exists one y -coordinate for each x -coordinate.
- 3) It is *not* a function because there are multiple y -values for a given x -value.
- 4) It is *not* a function because there are multiple x -values for a given y -value.

- 150 Mrs. Smith wrote "Eight less than three times a number is greater than fifteen" on the board. If x represents the number, which inequality is a correct translation of this statement?

- 1) $3x - 8 > 15$
- 2) $3x - 8 < 15$
- 3) $8 - 3x > 15$
- 4) $8 - 3x < 15$

- 151 Which graph does *not* represent a function?

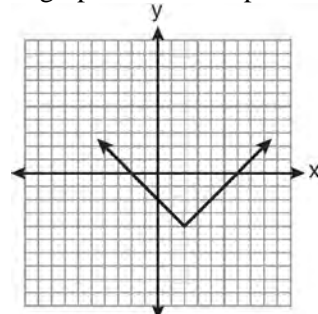

1)

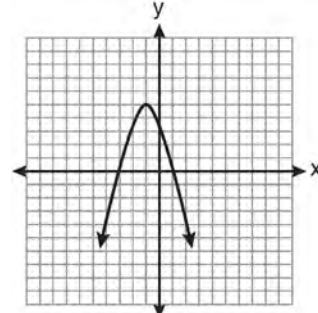

2)

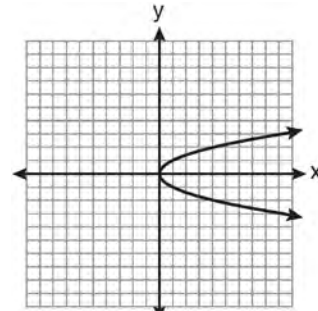

3)

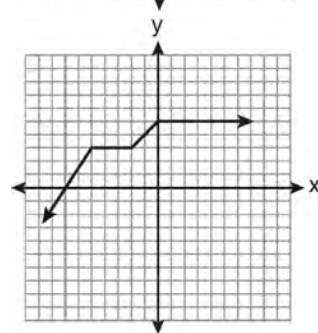

4)

Integrated Algebra Multiple Choice Regents Exam Questions

www.jmap.org

- 152 The box-and-whisker plot below represents the ages of 12 people.

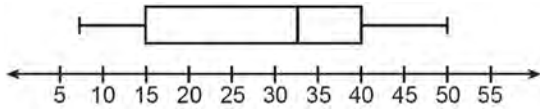

What percentage of these people are age 15 or older?

- 1) 25
 2) 35
 3) 75
 4) 85
- 153 If $3ax + b = c$, then x equals
- 1) $c - b + 3a$
 2) $c + b - 3a$
 3) $\frac{c - b}{3a}$
 4) $\frac{b - c}{3a}$

- 154 Which expression represents $\frac{2x^2 - 12x}{x - 6}$ in simplest form?
- 1) 0
 2) $2x$
 3) $4x$
 4) $2x + 2$

- 155 What is an equation for the line that passes through the coordinates (2,0) and (0,3)?

- 1) $y = -\frac{3}{2}x + 3$
 2) $y = -\frac{3}{2}x - 3$
 3) $y = -\frac{2}{3}x + 2$
 4) $y = -\frac{2}{3}x - 2$

- 156 What is the additive inverse of the expression $a - b$?

- 1) $a + b$
 2) $a - b$
 3) $-a + b$
 4) $-a - b$

- 157 Ryan estimates the measurement of the volume of a popcorn container to be 282 cubic inches. The actual volume of the popcorn container is 289 cubic inches. What is the relative error of Ryan's measurement to the nearest thousandth?

- 1) 0.024
 2) 0.025
 3) 0.096
 4) 1.025

- 158 Which value of n makes the expression $\frac{5n}{2n - 1}$ undefined?

- 1) 1
 2) 0
 3) $-\frac{1}{2}$
 4) $\frac{1}{2}$

Integrated Algebra Multiple Choice Regents Exam Questions

www.jmap.org

159 Which expression represents $\frac{(2x^3)(8x^5)}{4x^6}$ in

simplest form?

- 1) x^2
- 2) x^9
- 3) $4x^2$
- 4) $4x^9$

160 The expression $9x^2 - 100$ is equivalent to

- 1) $(9x - 10)(x + 10)$
- 2) $(3x - 10)(3x + 10)$
- 3) $(3x - 100)(3x - 1)$
- 4) $(9x - 100)(x + 1)$

161 Which property is illustrated by the equation

$$ax + ay = a(x + y)?$$

- 1) associative
- 2) commutative
- 3) distributive
- 4) identity

162 Alex earned scores of 60, 74, 82, 87, 87, and 94 on his first six algebra tests. What is the relationship between the measures of central tendency of these scores?

- 1) median < mode < mean
- 2) mean < mode < median
- 3) mode < median < mean
- 4) mean < median < mode

163 Which value of x is a solution of $\frac{5}{x} = \frac{x+13}{6}$?

- 1) -2
- 2) -3
- 3) -10
- 4) -15

164 Tamara has a cell phone plan that charges \$0.07 per minute plus a monthly fee of \$19.00. She budgets \$29.50 per month for total cell phone expenses without taxes. What is the maximum number of minutes Tamara could use her phone each month in order to stay within her budget?

- 1) 150
- 2) 271
- 3) 421
- 4) 692

165 The equation $y = -x^2 - 2x + 8$ is graphed on the set of axes below.

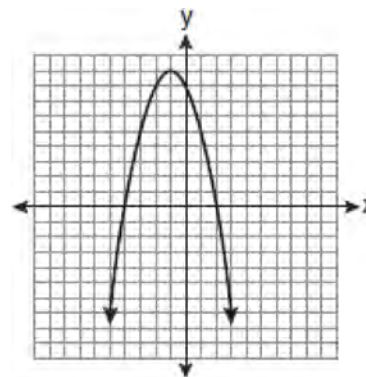

Based on this graph, what are the roots of the equation $-x^2 - 2x + 8 = 0$?

- 1) 8 and 0
- 2) 2 and -4
- 3) 9 and -1
- 4) 4 and -2

Integrated Algebra Multiple Choice Regents Exam Questions

www.jmap.org

- 166 Consider the set of integers greater than -2 and less than 6 . A subset of this set is the positive factors of 5 . What is the complement of this subset?
- 1) $\{0, 2, 3, 4\}$
 - 2) $\{-1, 0, 2, 3, 4\}$
 - 3) $\{-2, -1, 0, 2, 3, 4, 6\}$
 - 4) $\{-2, -1, 0, 1, 2, 3, 4, 5, 6\}$

- 167 An online music club has a one-time registration fee of $\$13.95$ and charges $\$0.49$ to buy each song. If Emma has $\$50.00$ to join the club and buy songs, what is the maximum number of songs she can buy?
- 1) 73
 - 2) 74
 - 3) 130
 - 4) 131

- 168 A cylindrical container has a diameter of 12 inches and a height of 15 inches, as illustrated in the diagram below.

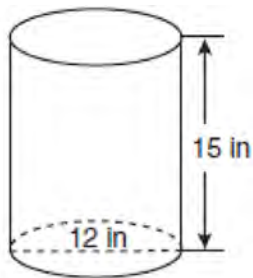

(Not drawn to scale)

What is the volume of this container to the *nearest tenth* of a cubic inch?

- 1) 6,785.8
- 2) 4,241.2
- 3) 2,160.0
- 4) 1,696.5

- 169 Which equation represents a line that is parallel to the line $y = 3 - 2x$?

- 1) $4x + 2y = 5$
- 2) $2x + 4y = 1$
- 3) $y = 3 - 4x$
- 4) $y = 4x - 2$

- 170 What is the slope of the line that passes through the points $(-5, 4)$ and $(15, -4)$?

- 1) $-\frac{2}{5}$
- 2) 0
- 3) $-\frac{5}{2}$
- 4) undefined

- 171 Given: $A = \{2, 4, 5, 7, 8\}$

$$B = \{3, 5, 8, 9\}$$

What is $A \cup B$?

- 1) $\{5\}$
- 2) $\{5, 8\}$
- 3) $\{2, 3, 4, 7, 9\}$
- 4) $\{2, 3, 4, 5, 7, 8, 9\}$

- 172 Pam is playing with red and black marbles. The number of red marbles she has is three more than twice the number of black marbles she has. She has 42 marbles in all. How many red marbles does Pam have?

- 1) 13
- 2) 15
- 3) 29
- 4) 33

Integrated Algebra Multiple Choice Regents Exam Questions

www.jmap.org

- 173 What is the sum of $\frac{2y}{y+5}$ and $\frac{10}{y+5}$ expressed in simplest form?
- 1) 1
 - 2) 2
 - 3) $\frac{12y}{y+5}$
 - 4) $\frac{2y+10}{y+5}$

- 174 Which expression is equivalent to $(3x^2)^3$?
- 1) $9x^5$
 - 2) $9x^6$
 - 3) $27x^5$
 - 4) $27x^6$

- 175 The table below shows a cumulative frequency distribution of runners' ages.

Cumulative Frequency Distribution of Runners' Ages

Age Group	Total
20-29	8
20-39	18
20-49	25
20-59	31
20-69	35

According to the table, how many runners are in their forties?

- 1) 25
- 2) 10
- 3) 7
- 4) 6

- 176 Given:
 Set $A = \{(-2, -1), (-1, 0), (1, 8)\}$
 Set $B = \{(-3, -4), (-2, -1), (-1, 2), (1, 8)\}$.
 What is the intersection of sets A and B ?
- 1) $\{(1, 8)\}$
 - 2) $\{(-2, -1)\}$
 - 3) $\{(-2, -1), (1, 8)\}$
 - 4) $\{(-3, -4), (-2, -1), (-1, 2), (-1, 0), (1, 8)\}$

- 177 Which value of x is in the solution set of the inequality $-2(x - 5) < 4$?
- 1) 0
 - 2) 2
 - 3) 3
 - 4) 5

- 178 A movie theater recorded the number of tickets sold daily for a popular movie during the month of June. The box-and-whisker plot shown below represents the data for the number of tickets sold, in hundreds.

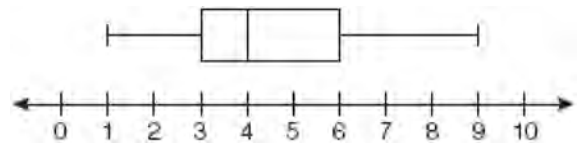

Which conclusion can be made using this plot?

- 1) The second quartile is 600.
- 2) The mean of the attendance is 400.
- 3) The range of the attendance is 300 to 600.
- 4) Twenty-five percent of the attendance is between 300 and 400.

179 For which value of x is $\frac{x-3}{x^2-4}$ undefined?

- 1) -2
- 2) 0
- 3) 3
- 4) 4

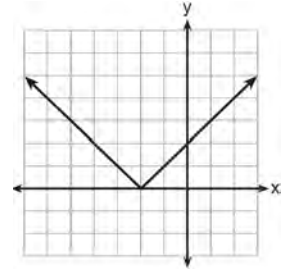

180 Which inequality is represented by the graph below?

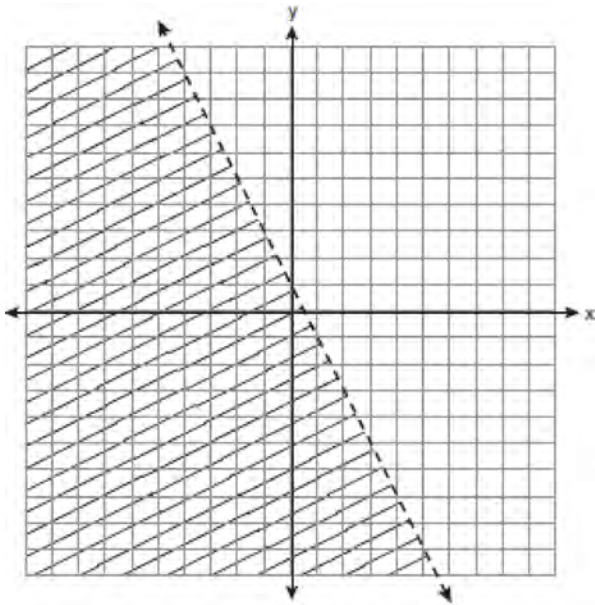

- 1) $y < 2x + 1$
- 2) $y < -2x + 1$
- 3) $y < \frac{1}{2}x + 1$
- 4) $y < -\frac{1}{2}x + 1$

181 The graph of $y = |x + 2|$ is shown below.

Which graph represents $y = -|x + 2|$?

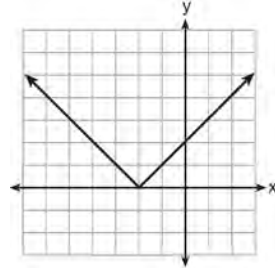

1)

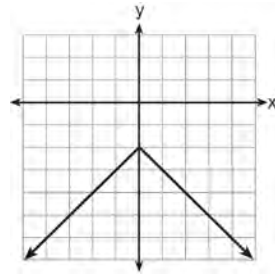

2)

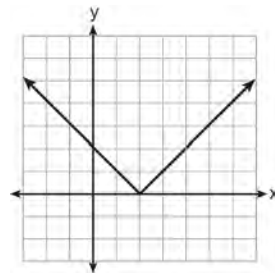

3)

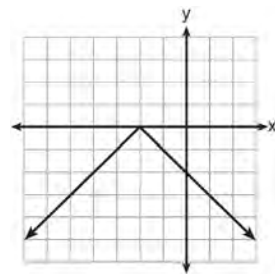

4)

Integrated Algebra Multiple Choice Regents Exam Questions

www.jmap.org

- 182 Students in Ms. Nazzeer's mathematics class tossed a six-sided number cube whose faces are numbered 1 to 6. The results are recorded in the table below.

Result	Frequency
1	3
2	6
3	4
4	6
5	4
6	7

Based on these data, what is the empirical probability of tossing a 4?

- 1) $\frac{8}{30}$
 - 2) $\frac{6}{30}$
 - 3) $\frac{5}{30}$
 - 4) $\frac{1}{30}$
- 183 What is the product of $\frac{x^2 - 1}{x + 1}$ and $\frac{x + 3}{3x - 3}$ expressed in simplest form?

- 1) x
- 2) $\frac{x}{3}$
- 3) $x + 3$
- 4) $\frac{x + 3}{3}$

- 184 Which set of data can be classified as quantitative?
- 1) first names of students in a chess club
 - 2) ages of students in a government class
 - 3) hair colors of students in a debate club
 - 4) favorite sports of students in a gym class

- 185 The center pole of a tent is 8 feet long, and a side of the tent is 12 feet long as shown in the diagram below.

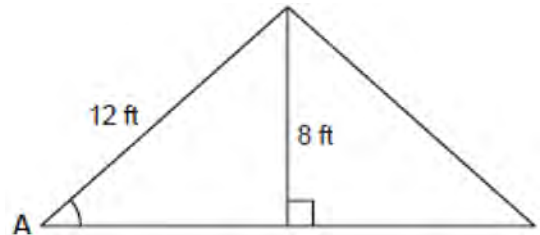

If a right angle is formed where the center pole meets the ground, what is the measure of angle A to the nearest degree?

- 1) 34
- 2) 42
- 3) 48
- 4) 56

- 186 Rhonda has \$1.35 in nickels and dimes in her pocket. If she has six more dimes than nickels, which equation can be used to determine x , the number of nickels she has?

- 1) $0.05(x + 6) + 0.10x = 1.35$
- 2) $0.05x + 0.10(x + 6) = 1.35$
- 3) $0.05 + 0.10(6x) = 1.35$
- 4) $0.15(x + 6) = 1.35$

Integrated Algebra Multiple Choice Regents Exam Questions

www.jmap.org

- 187 The number of hours spent on math homework each week and the final exam grades for twelve students in Mr. Dylan's algebra class are plotted below.

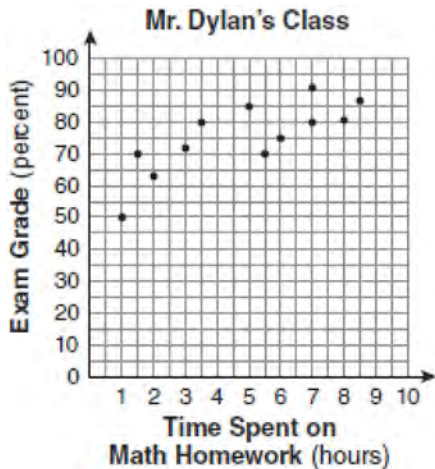

Based on a line of best fit, which exam grade is the best prediction for a student who spends about 4 hours on math homework each week?

- 1) 62
 - 2) 72
 - 3) 82
 - 4) 92
- 188 The expression $\frac{9x^4 - 27x^6}{3x^3}$ is equivalent to
- 1) $3x(1 - 3x)$
 - 2) $3x(1 - 3x^2)$
 - 3) $3x(1 - 9x^5)$
 - 4) $9x^3(1 - x)$
- 189 The set $\{11, 12\}$ is equivalent to
- 1) $\{x \mid 11 < x < 12, \text{ where } x \text{ is an integer}\}$
 - 2) $\{x \mid 11 < x \leq 12, \text{ where } x \text{ is an integer}\}$
 - 3) $\{x \mid 10 \leq x < 12, \text{ where } x \text{ is an integer}\}$
 - 4) $\{x \mid 10 < x \leq 12, \text{ where } x \text{ is an integer}\}$

- 190 Which equation represents a line parallel to the x -axis?

- 1) $x = 5$
- 2) $y = 10$
- 3) $x = \frac{1}{3}y$
- 4) $y = 5x + 17$

- 191 Mr. Smith invested \$2,500 in a savings account that earns 3% interest compounded annually. He made no additional deposits or withdrawals. Which expression can be used to determine the number of dollars in this account at the end of 4 years?

- 1) $2500(1 + 0.03)^4$
- 2) $2500(1 + 0.3)^4$
- 3) $2500(1 + 0.04)^3$
- 4) $2500(1 + 0.4)^3$

- 192 What is the value of x , in inches, in the right triangle below?

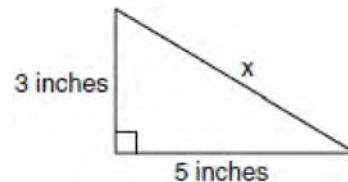

- 1) $\sqrt{15}$
- 2) 8
- 3) $\sqrt{34}$
- 4) 4

Integrated Algebra Multiple Choice Regents Exam Questions

www.jmap.org

193 What are the roots of the equation

$$x^2 - 10x + 21 = 0?$$

- 1) 1 and 21
- 2) -5 and -5
- 3) 3 and 7
- 4) -3 and -7

194 A swim team member performs a dive from a 14-foot-high springboard. The parabola below shows the path of her dive.

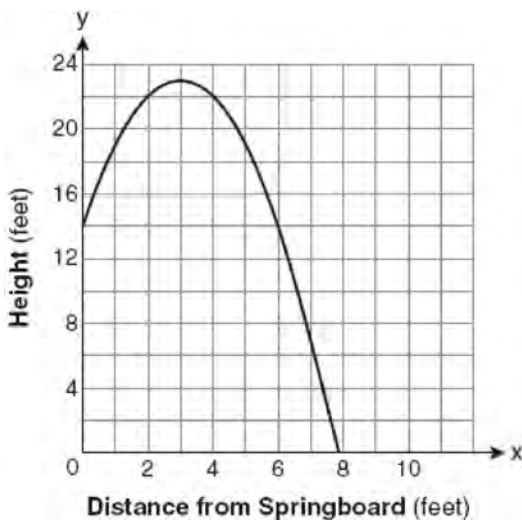

Which equation represents the axis of symmetry?

- 1) $x = 3$
- 2) $y = 3$
- 3) $x = 23$
- 4) $y = 23$

195 Which set builder notation describes

$$\{-2, -1, 0, 1, 2, 3\}?$$

- 1) $\{x \mid -3 \leq x \leq 3, \text{ where } x \text{ is an integer}\}$
- 2) $\{x \mid -3 < x \leq 4, \text{ where } x \text{ is an integer}\}$
- 3) $\{x \mid -2 < x < 3, \text{ where } x \text{ is an integer}\}$
- 4) $\{x \mid -2 \leq x < 4, \text{ where } x \text{ is an integer}\}$

196 Kathy plans to purchase a car that depreciates (loses value) at a rate of 14% per year. The initial cost of the car is \$21,000. Which equation represents the value, v , of the car after 3 years?

- 1) $v = 21,000(0.14)^3$
- 2) $v = 21,000(0.86)^3$
- 3) $v = 21,000(1.14)^3$
- 4) $v = 21,000(0.86)(3)$

197 Mrs. Ayer is painting the outside of her son's toy box, including the top and bottom. The toy box measures 3 feet long, 1.5 feet wide, and 2 feet high. What is the total surface area she will paint?

- 1) 9.0 ft^2
- 2) 13.5 ft^2
- 3) 22.5 ft^2
- 4) 27.0 ft^2

198 Which value of x is in the solution set of the inequality $-2x + 5 > 17$?

- 1) -8
- 2) -6
- 3) -4
- 4) 12

199 Sam and Odel have been selling frozen pizzas for a class fundraiser. Sam has sold half as many pizzas as Odel. Together they have sold a total of 126 pizzas. How many pizzas did Sam sell?

- 1) 21
- 2) 42
- 3) 63
- 4) 84

Integrated Algebra Multiple Choice Regents Exam Questions

www.jmap.org

200 What is the speed, in meters per second, of a paper airplane that flies 24 meters in 6 seconds?

- 1) 144
- 2) 30
- 3) 18
- 4) 4

201 What is the sum of $\frac{d}{2}$ and $\frac{2d}{3}$ expressed in simplest form?

- 1) $\frac{3d}{5}$
- 2) $\frac{3d}{6}$
- 3) $\frac{7d}{5}$
- 4) $\frac{7d}{6}$

202 A survey is being conducted to determine which types of television programs people watch. Which survey and location combination would likely contain the most bias?

- 1) surveying 10 people who work in a sporting goods store
- 2) surveying the first 25 people who enter a grocery store
- 3) randomly surveying 50 people during the day in a mall
- 4) randomly surveying 75 people during the day in a clothing store

203 A playground in a local community consists of a rectangle and two semicircles, as shown in the diagram below.

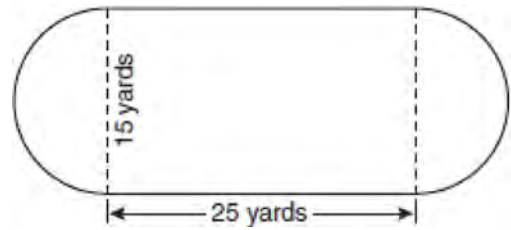

Which expression represents the amount of fencing, in yards, that would be needed to completely enclose the playground?

- 1) $15\pi + 50$
- 2) $15\pi + 80$
- 3) $30\pi + 50$
- 4) $30\pi + 80$

204 The data set 5, 6, 7, 8, 9, 9, 9, 10, 12, 14, 17, 17, 18, 19, 19 represents the number of hours spent on the Internet in a week by students in a mathematics class. Which box-and-whisker plot represents the data?

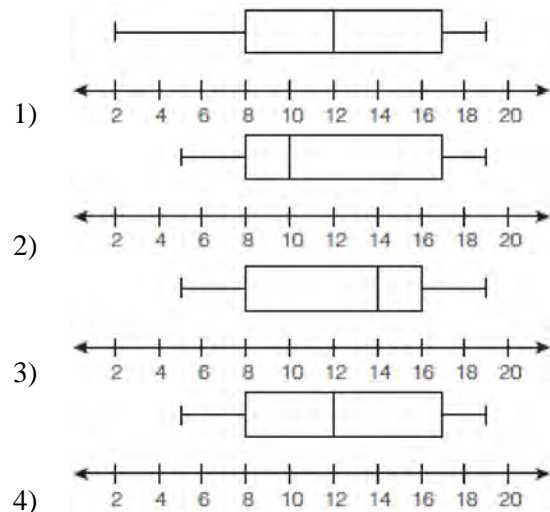

Integrated Algebra Multiple Choice Regents Exam Questions

www.jmap.org

205 Which equation is represented by the graph below?

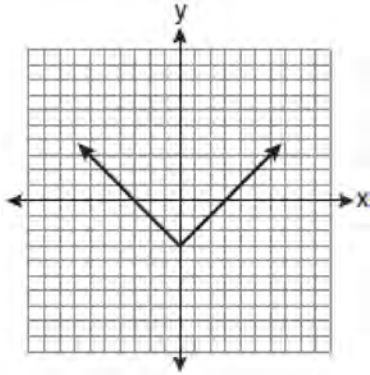

- 1) $y = x^2 - 3$
- 2) $y = (x - 3)^2$
- 3) $y = |x| - 3$
- 4) $y = |x - 3|$

206 Which relation is *not* a function?

- 1) $\{(1, 5), (2, 6), (3, 6), (4, 7)\}$
- 2) $\{(4, 7), (2, 1), (-3, 6), (3, 4)\}$
- 3) $\{(-1, 6), (1, 3), (2, 5), (1, 7)\}$
- 4) $\{(-1, 2), (0, 5), (5, 0), (2, -1)\}$

207 Which value of x is in the solution set of

$$\frac{4}{3}x + 5 < 17?$$

- 1) 8
- 2) 9
- 3) 12
- 4) 16

208 Nancy's rectangular garden is represented in the diagram below.

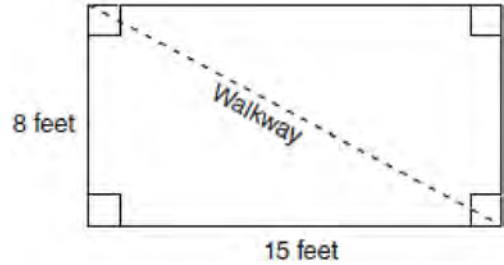

If a diagonal walkway crosses her garden, what is its length, in feet?

- 1) 17
- 2) 22
- 3) $\sqrt{161}$
- 4) $\sqrt{529}$

209 Which type of graph is shown in the diagram below?

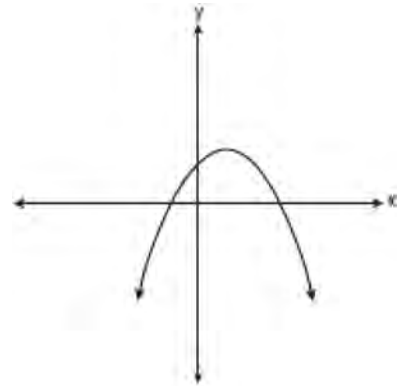

- 1) absolute value
- 2) exponential
- 3) linear
- 4) quadratic

Integrated Algebra Multiple Choice Regents Exam Questions

www.jmap.org

- 210 In the diagram of $\triangle ABC$ shown below, $BC = 10$
and $AB = 16$.

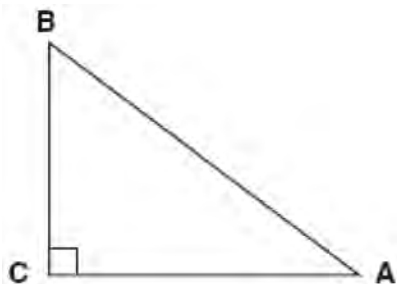

To the *nearest tenth of a degree*, what is the measure of the largest acute angle in the triangle?

- 1) 32.0
- 2) 38.7
- 3) 51.3
- 4) 90.0

Integrated Algebra Multiple Choice Regents Exam Questions

211 What is the solution of $3(2m - 1) \leq 4m + 7$?

- 1) $m \leq 5$
- 2) $m \geq 5$
- 3) $m \leq 4$
- 4) $m \geq 4$

212 A formula used for calculating velocity is

$$v = \frac{1}{2}at^2. \text{ What is } a \text{ expressed in terms of } v \text{ and } t?$$

- 1) $a = \frac{2v}{t}$
- 2) $a = \frac{2v}{t^2}$
- 3) $a = \frac{v}{t}$
- 4) $a = \frac{v}{2t^2}$

213 The graphs of the equations $y = 2x - 7$ and $y - kx = 7$ are parallel when k equals

- 1) -2
- 2) 2
- 3) -7
- 4) 7

214 Which interval notation represents the set of all numbers greater than or equal to 5 and less than 12?

- 1) $[5, 12)$
- 2) $(5, 12]$
- 3) $(5, 12)$
- 4) $[5, 12]$

215 Which data table represents univariate data?

1)

Side Length of a Square	Area of Square
2	4
3	9
4	16
5	25

2)

Hours Worked	Pay
20	\$160
25	\$200
30	\$240
35	\$280

3)

Age Group	Frequency
20-29	9
30-39	7
40-49	10
50-59	4

4)

People	Number of Fingers
2	20
3	30
4	40
5	50

Integrated Algebra Multiple Choice Regents Exam Questions

www.jmap.org

- 216 The expression $\frac{12w^9y^3}{-3w^3y^3}$ is equivalent to
- 1) $-4w^6$
 - 2) $-4w^3y$
 - 3) $9w^6$
 - 4) $9w^3y$
- 217 The sum of $4x^3 + 6x^2 + 2x - 3$ and $3x^3 + 3x^2 - 5x - 5$ is
- 1) $7x^3 + 3x^2 - 3x - 8$
 - 2) $7x^3 + 3x^2 + 7x + 2$
 - 3) $7x^3 + 9x^2 - 3x - 8$
 - 4) $7x^6 + 9x^4 - 3x^2 - 8$
- 218 Which expression represents $36x^2 - 100y^6$ factored completely?
- 1) $2(9x + 25y^3)(9x - 25y^3)$
 - 2) $4(3x + 5y^3)(3x - 5y^3)$
 - 3) $(6x + 10y^3)(6x - 10y^3)$
 - 4) $(18x + 50y^3)(18x - 50y^3)$
- 219 Which linear equation represents a line containing the point $(1,3)$?
- 1) $x + 2y = 5$
 - 2) $x - 2y = 5$
 - 3) $2x + y = 5$
 - 4) $2x - y = 5$
- 220 Ben has four more than twice as many CDs as Jake. If they have a total of 31 CDs, how many CDs does Jake have?
- 1) 9
 - 2) 13
 - 3) 14
 - 4) 22
- 221 Which value of x is the solution of $\frac{2x-3}{x-4} = \frac{2}{3}$?
- 1) $-\frac{1}{4}$
 - 2) $\frac{1}{4}$
 - 3) -4
 - 4) 4
- 222 Which expression is equivalent to $-3x(x-4) - 2x(x+3)$?
- 1) $-x^2 - 1$
 - 2) $-x^2 + 18x$
 - 3) $-5x^2 - 6x$
 - 4) $-5x^2 + 6x$
- 223 Steve ran a distance of 150 meters in $1\frac{1}{2}$ minutes. What is his speed in meters per hour?
- 1) 6
 - 2) 60
 - 3) 100
 - 4) 6,000

Integrated Algebra Multiple Choice Regents Exam Questions

www.jmap.org

- 224 What is the relationship between the independent and dependent variables in the scatter plot shown below?

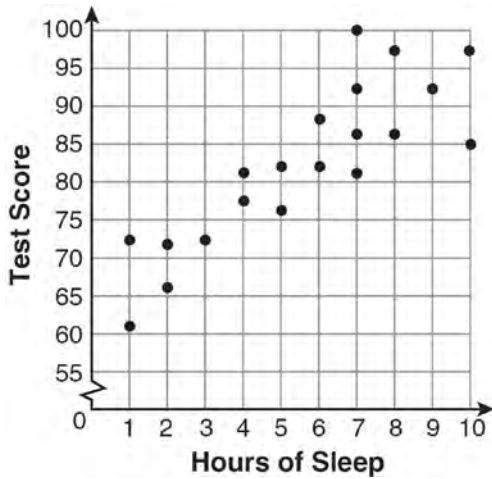

- 1) undefined correlation
 - 2) negative correlation
 - 3) positive correlation
 - 4) no correlation
- 225 The data in the table below are graphed, and the slope is examined.

x	y
0.5	9.0
1	8.75
1.5	8.5
2	8.25
2.5	8.0

The rate of change represented in this table can be described as

- 1) negative
- 2) positive
- 3) undefined
- 4) zero

- 226 What are the factors of the expression $x^2 + x - 20$?
- 1) $(x + 5)$ and $(x + 4)$
 - 2) $(x + 5)$ and $(x - 4)$
 - 3) $(x - 5)$ and $(x + 4)$
 - 4) $(x - 5)$ and $(x - 4)$

- 227 A bag contains eight green marbles, five white marbles, and two red marbles. What is the probability of drawing a red marble from the bag?
- 1) $\frac{1}{15}$
 - 2) $\frac{2}{15}$
 - 3) $\frac{2}{13}$
 - 4) $\frac{13}{15}$

- 228 Which situation does *not* describe a causal relationship?
- 1) The higher the volume on a radio, the louder the sound will be.
 - 2) The faster a student types a research paper, the more pages the paper will have.
 - 3) The shorter the distance driven, the less gasoline that will be used.
 - 4) The slower the pace of a runner, the longer it will take the runner to finish the race.

- 229 Given: Set $U = \{S, O, P, H, I, A\}$

$$\text{Set } B = \{A, I, O\}$$

If set B is a subset of set U , what is the complement of set B ?

- 1) $\{O, P, S\}$
- 2) $\{I, P, S\}$
- 3) $\{A, H, P\}$
- 4) $\{H, P, S\}$

Integrated Algebra Multiple Choice Regents Exam Questions

www.jmap.org

- 230 In the diagram below, $MATH$ is a rectangle, $GB = 4.6$, $MH = 6$, and $HT = 15$.

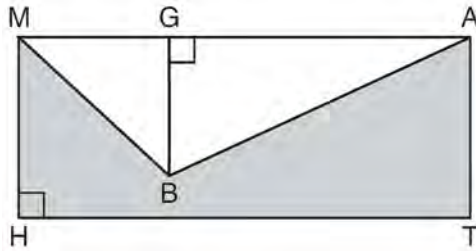

What is the area of polygon $MBATH$?

- 1) 34.5
 2) 55.5
 3) 90.0
 4) 124.5
- 231 Which algebraic expression represents 15 less than x divided by 9?
- 1) $\frac{x}{9} - 15$
 2) $9x - 15$
 3) $15 - \frac{x}{9}$
 4) $15 - 9x$

- 232 What is the quotient of $\frac{x}{x+4}$ divided by $\frac{2x}{x^2-16}$?

- 1) $\frac{2}{x-4}$
 2) $\frac{2x^2}{x-4}$
 3) $\frac{2x^2}{x^2-16}$
 4) $\frac{x-4}{2}$

- 233 Corinne calculated the area of a paper plate to be 50.27 square inches. If the actual area of the plate is 55.42 square inches, what is the relative error in calculating the area, to the nearest thousandth?
- 1) 0.092
 2) 0.093
 3) 0.102
 4) 0.103

- 234 Julia went to the movies and bought one jumbo popcorn and two chocolate chip cookies for \$5.00. Marvin went to the same movie and bought one jumbo popcorn and four chocolate chip cookies for \$6.00. How much does one chocolate chip cookie cost?
- 1) \$0.50
 2) \$0.75
 3) \$1.00
 4) \$2.00

- 235 The freshman class held a canned food drive for 12 weeks. The results are summarized in the table below.

Canned Food Drive Results

Week	1	2	3	4	5	6	7	8	9	10	11	12
Number of Cans	20	35	32	45	58	46	28	23	31	79	65	62

Which number represents the second quartile of the number of cans of food collected?

- 1) 29.5
 2) 30.5
 3) 40
 4) 60
- 236 The maximum height and speed of various roller coasters in North America are shown in the table below.

Integrated Algebra Multiple Choice Regents Exam Questions

www.jmap.org

Maximum Speed, in mph, (x)	45	50	54	60	65	70
Maximum Height, in feet, (y)	63	80	105	118	141	107

Which graph represents a correct scatter plot of the data?

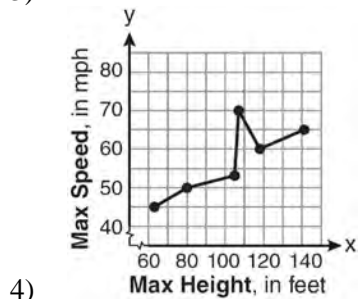
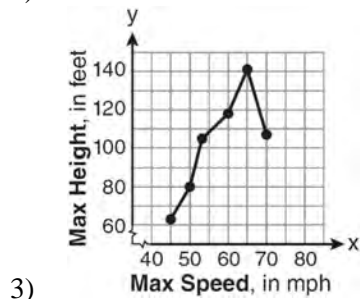
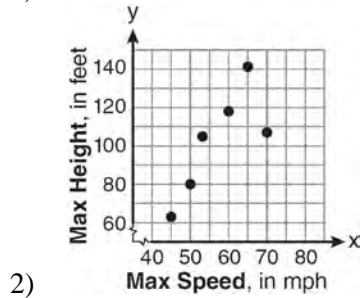
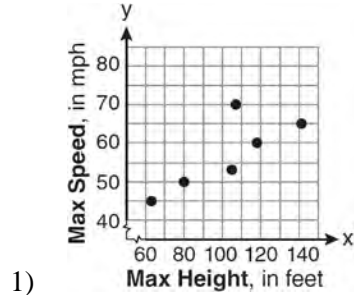

237 Which data set describes a situation that could be classified as quantitative?

- 1) the phone numbers in a telephone book
- 2) the addresses for students at Hopkins High School
- 3) the zip codes of residents in the city of Buffalo, New York
- 4) the time it takes each of Mr. Harper's students to complete a test

238 What is the slope of the line passing through the points *A* and *B*, as shown on the graph below?

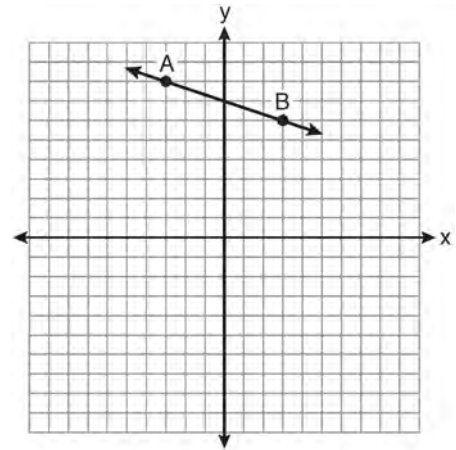

- 1) -3
- 2) $-\frac{1}{3}$
- 3) 3
- 4) $\frac{1}{3}$

Integrated Algebra Multiple Choice Regents Exam Questions

www.jmap.org

239 Which equation represents the line that passes through the points $(-3, 7)$ and $(3, 3)$?

- 1) $y = \frac{2}{3}x + 1$
- 2) $y = \frac{2}{3}x + 9$
- 3) $y = -\frac{2}{3}x + 5$
- 4) $y = -\frac{2}{3}x + 9$

240 The expression $x^2 - 36y^2$ is equivalent to

- 1) $(x - 6y)(x - 6y)$
- 2) $(x - 18y)(x - 18y)$
- 3) $(x + 6y)(x - 6y)$
- 4) $(x + 18y)(x - 18y)$

241 A study showed that a decrease in the cost of carrots led to an increase in the number of carrots sold. Which statement best describes this relationship?

- 1) positive correlation and a causal relationship
- 2) negative correlation and a causal relationship
- 3) positive correlation and not a causal relationship
- 4) negative correlation and not a causal relationship

242 A right triangle contains a 38° angle whose adjacent side measures 10 centimeters. What is the length of the hypotenuse, to the *nearest hundredth of a centimeter*?

- 1) 7.88
- 2) 12.69
- 3) 12.80
- 4) 16.24

243 What is the perimeter of a regular pentagon with a side whose length is $x + 4$?

- 1) $x^2 + 16$
- 2) $4x + 16$
- 3) $5x + 4$
- 4) $5x + 20$

244 If $\frac{ey}{n} + k = t$, what is y in terms of e , n , k , and t ?

- 1) $y = \frac{tn + k}{e}$
- 2) $y = \frac{tn - k}{e}$
- 3) $y = \frac{n(t + k)}{e}$
- 4) $y = \frac{n(t - k)}{e}$

245 Right triangle ABC has legs of 8 and 15 and a hypotenuse of 17, as shown in the diagram below.

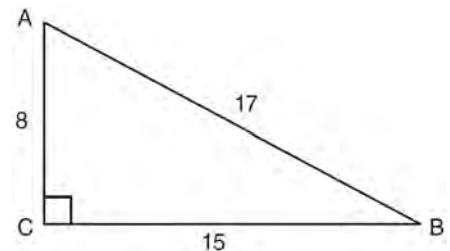

The value of the tangent of $\angle B$ is

- 1) 0.4706
- 2) 0.5333
- 3) 0.8824
- 4) 1.8750

Integrated Algebra Multiple Choice Regents Exam Questions

www.jmap.org

- 246 In the diagram below, what is the slope of the line passing through points A and B?

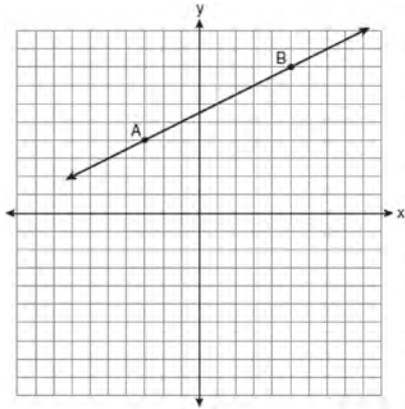

- 1) -2
- 2) 2
- 3) $-\frac{1}{2}$
- 4) $\frac{1}{2}$

- 247 A figure is made up of a rectangle and a semicircle as shown in the diagram below.

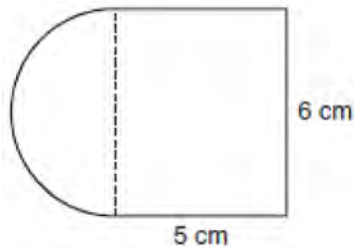

What is the area of the figure, to the nearest tenth of a square centimeter?

- 1) 39.4
- 2) 44.1
- 3) 48.8
- 4) 58.3

- 248 What is the solution of the inequality $-6x - 17 \geq 8x + 25$?

- 1) $x \geq 3$
- 2) $x \leq 3$
- 3) $x \geq -3$
- 4) $x \leq -3$

- 249 The box-and-whisker plot below represents the math test scores of 20 students.

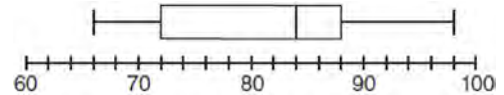

What percentage of the test scores are less than 72?

- 1) 25
- 2) 50
- 3) 75
- 4) 100

- 250 A survey is being conducted to determine which school board candidate would best serve the Yonkers community. Which group, when randomly surveyed, would likely produce the most bias?

- 1) 15 employees of the Yonkers school district
- 2) 25 people driving past Yonkers High School
- 3) 75 people who enter a Yonkers grocery store
- 4) 100 people who visit the local Yonkers shopping mall

- 251 An example of an algebraic expression is

- 1) $y = mx + b$
- 2) $3x + 4y - 7$
- 3) $2x + 3y \leq 18$
- 4) $(x + y)(x - y) = 25$

Integrated Algebra Multiple Choice Regents Exam Questions

www.jmap.org

252 Which point lies on the line whose equation is $2x - 3y = 9$?

- 1) $(-1, -3)$
- 2) $(-1, 3)$
- 3) $(0, 3)$
- 4) $(0, -3)$

253 What are the roots of the equation $x^2 - 5x + 6 = 0$?

- 1) 1 and -6
- 2) 2 and 3
- 3) -1 and 6
- 4) -2 and -3

254 Which set of data can be classified as qualitative?

- 1) scores of students in an algebra class
- 2) ages of students in a biology class
- 3) numbers of students in history classes
- 4) eye colors of students in an economics class

255 The value of a car purchased for \$20,000 decreases at a rate of 12% per year. What will be the value of the car after 3 years?

- 1) \$12,800.00
- 2) \$13,629.44
- 3) \$17,600.00
- 4) \$28,098.56

256 Which equation represents a line parallel to the graph of $2x - 4y = 16$?

- 1) $y = \frac{1}{2}x - 5$
- 2) $y = -\frac{1}{2}x + 4$
- 3) $y = -2x + 6$
- 4) $y = 2x + 8$

257 Which ratio represents $\sin x$ in the right triangle shown below?

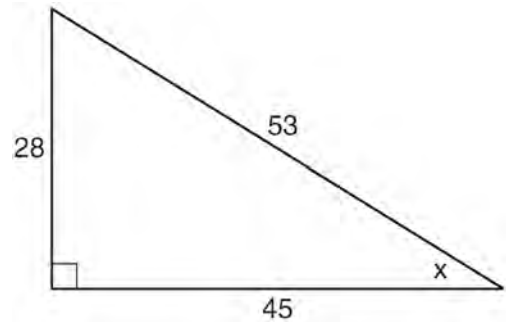

- 1) $\frac{28}{53}$
- 2) $\frac{28}{45}$
- 3) $\frac{45}{53}$
- 4) $\frac{53}{28}$

258 Which equation shows a correct trigonometric ratio for angle A in the right triangle below?

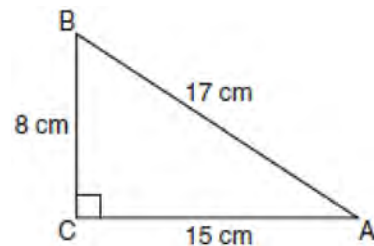

- 1) $\sin A = \frac{15}{17}$
- 2) $\tan A = \frac{8}{17}$
- 3) $\cos A = \frac{15}{17}$
- 4) $\tan A = \frac{5}{8}$

Integrated Algebra Multiple Choice Regents Exam Questions

www.jmap.org

259 If the universal set is {pennies, nickels, dimes, quarters}, what is the complement of the set {nickels}?

- 1) { }
- 2) {pennies, quarters}
- 3) {pennies, dimes, quarters}
- 4) {pennies, nickels, dimes, quarters}

260 A student correctly graphed the parabola shown below to solve a given quadratic equation.

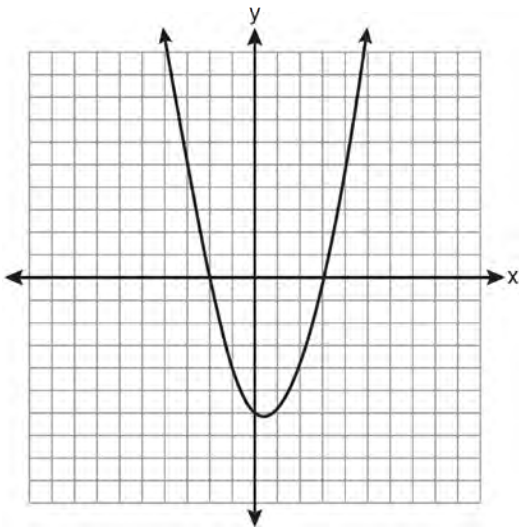

What are the roots of the quadratic equation associated with this graph?

- 1) -6 and 3
- 2) -6 and 0
- 3) -3 and 2
- 4) -2 and 3

261 What is the value of the expression $-3x^2y + 4x$ when $x = -4$ and $y = 2$?

- 1) -112
- 2) -80
- 3) 80
- 4) 272

262 Which ordered pair is in the solution set of the system of linear inequalities graphed below?

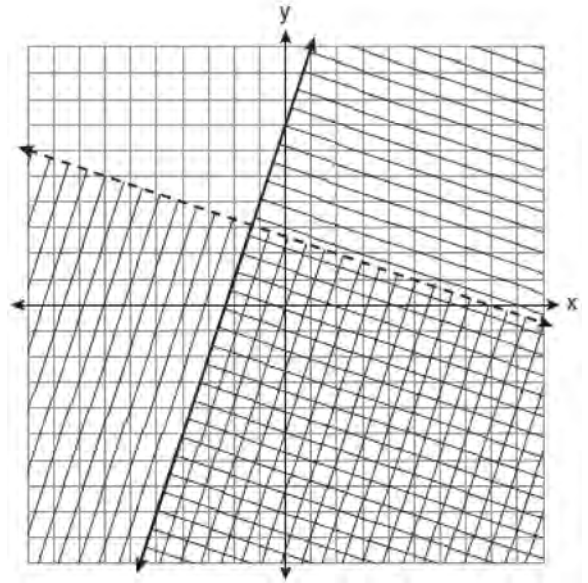

- 1) (1, -4)
- 2) (-5, 7)
- 3) (5, 3)
- 4) (-7, -2)

263 The ninth grade class at a local high school needs to purchase a park permit for \$250.00 for their upcoming class picnic. Each ninth grader attending the picnic pays \$0.75. Each guest pays \$1.25. If 200 ninth graders attend the picnic, which inequality can be used to determine the number of guests, x , needed to cover the cost of the permit?

- 1) $0.75x - (1.25)(200) \geq 250.00$
- 2) $0.75x + (1.25)(200) \geq 250.00$
- 3) $(0.75)(200) - 1.25x \geq 250.00$
- 4) $(0.75)(200) + 1.25x \geq 250.00$

Integrated Algebra Multiple Choice Regents Exam Questions

www.jmap.org

264 What is the product of (6×10^3) , (4.6×10^5) , and (2×10^{-2}) expressed in scientific notation?

- 1) 55.2×10^6
- 2) 5.52×10^7
- 3) 55.2×10^7
- 4) 5.52×10^{10}

265 Which is the graph of $y = |x| + 2$?

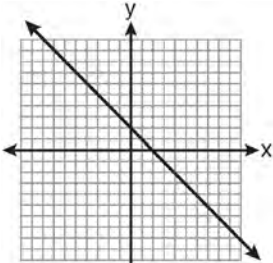

1)

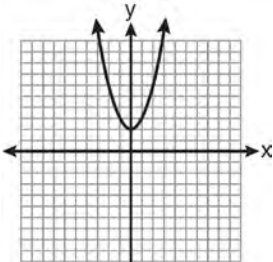

2)

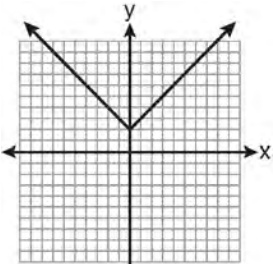

3)

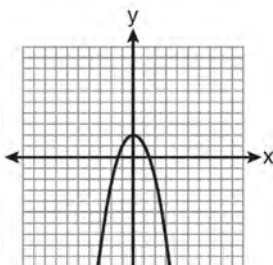

4)

266 Which ordered pair is in the solution set of the system of inequalities shown in the graph below?

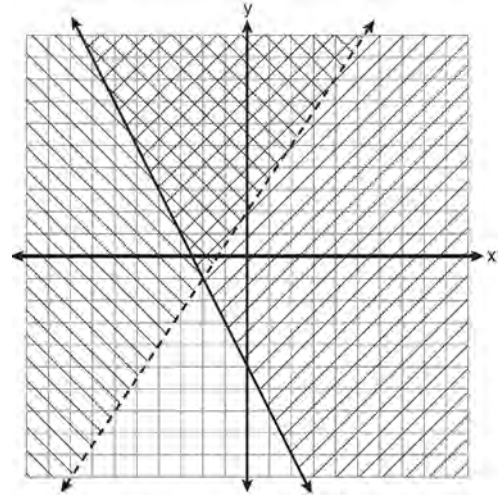

- 1) $(-2, -1)$
- 2) $(-2, 2)$
- 3) $(-2, -4)$
- 4) $(2, -2)$

267 Which expression is equivalent to $121 - x^2$?

- 1) $(x - 11)(x - 11)$
- 2) $(x + 11)(x - 11)$
- 3) $(11 - x)(11 + x)$
- 4) $(11 - x)(11 - x)$

268 Which value of x is the solution of $\frac{x}{3} + \frac{x+1}{2} = x$?

- 1) 1
- 2) -1
- 3) 3
- 4) -3

Integrated Algebra Multiple Choice Regents Exam Questions

www.jmap.org

269 What is the sum of $\frac{3x^2}{x-2}$ and $\frac{x^2}{x-2}$?

- 1) $\frac{3x^4}{(x-2)^2}$
- 2) $\frac{3x^4}{x-2}$
- 3) $\frac{4x^2}{(x-2)^2}$
- 4) $\frac{4x^2}{x-2}$

270 This year, John played in 10 baseball games. In these games he had hit the ball 2, 3, 0, 1, 3, 2, 4, 0, 2, and 3 times. In the first 10 games he plays next year, John wants to increase his average (mean) hits per game by 0.5. What is the total number of hits John needs over the first 10 games next year to achieve his goal?

- 1) 5
- 2) 2
- 3) 20
- 4) 25

271 What is the solution set of $\frac{x+2}{x-2} = \frac{-3}{x}$?

- 1) $\{-2, 3\}$
- 2) $\{-3, -2\}$
- 3) $\{-1, 6\}$
- 4) $\{-6, 1\}$

272 Which graph can be used to find the solution of the following system of equations?

$$y = x^2 + 2x + 3$$

$$2y - 2x = 10$$

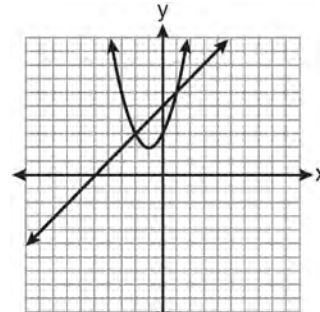

1)

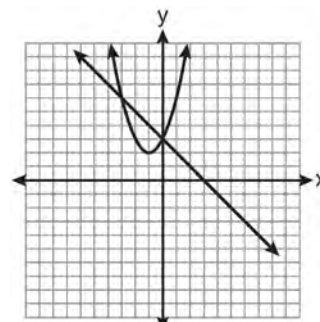

2)

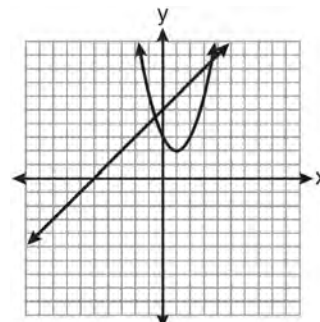

3)

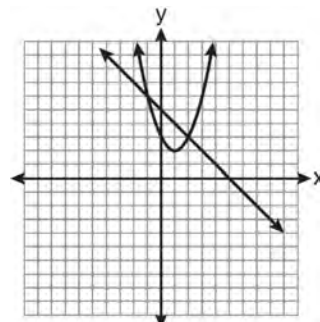

4)

Integrated Algebra Multiple Choice Regents Exam Questions

www.jmap.org

273 Given: $Q = \{0,2,4,6\}$

$W = \{0,1,2,3\}$

$Z = \{1,2,3,4\}$

What is the intersection of sets Q , W , and Z ?

- 1) $\{2\}$
- 2) $\{0,2\}$
- 3) $\{1,2,3\}$
- 4) $\{0,1,2,3,4,6\}$

274 Three high school juniors, Reese, Matthew, and Chris, are running for student council president. A survey is taken a week before the election asking 40 students which candidate they will vote for in the election. The results are shown in the table below.

Candidate's Name	Number of Students Supporting Candidate
Reese	15
Matthew	13
Chris	12

Based on the table, what is the probability that a student will vote for Reese?

- 1) $\frac{1}{3}$
- 2) $\frac{3}{5}$
- 3) $\frac{3}{8}$
- 4) $\frac{5}{8}$

275 Which type of function is represented by the graph shown below?

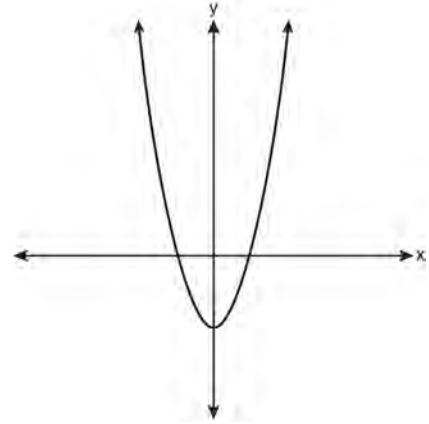

- 1) absolute value
- 2) exponential
- 3) linear
- 4) quadratic

276 In $\triangle ABC$, the measure of $\angle B = 90^\circ$, $AC = 50$, $AB = 48$, and $BC = 14$. Which ratio represents the tangent of $\angle A$?

- 1) $\frac{14}{50}$
- 2) $\frac{14}{48}$
- 3) $\frac{48}{50}$
- 4) $\frac{48}{14}$

277 Which set-builder notation describes $\{-3, -2, -1, 0, 1, 2\}$?

- 1) $\{x \mid -3 \leq x < 2, \text{ where } x \text{ is an integer}\}$
- 2) $\{x \mid -3 < x \leq 2, \text{ where } x \text{ is an integer}\}$
- 3) $\{x \mid -3 < x < 2, \text{ where } x \text{ is an integer}\}$
- 4) $\{x \mid -3 \leq x \leq 2, \text{ where } x \text{ is an integer}\}$

Integrated Algebra Multiple Choice Regents Exam Questions

www.jmap.org

278 Which graph represents a function?

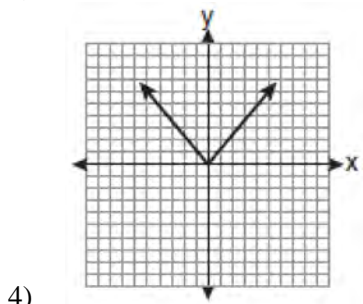
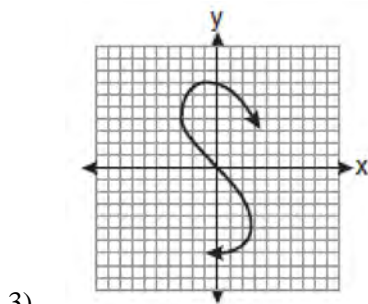
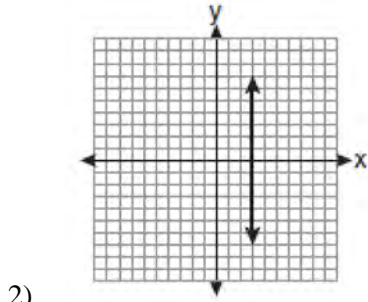
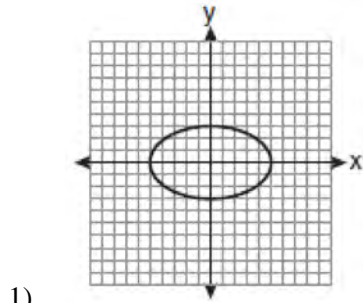

279 The current student population of the Brentwood Student Center is 2,000. The enrollment at the center increases at a rate of 4% each year. To the *nearest whole number*, what will the student population be closest to in 3 years?

- 1) 2,240
- 2) 2,250
- 3) 5,488
- 4) 6,240

280 What is the value of x in the equation

$$2(x - 4) = 4(2x + 1)?$$

- 1) -2
- 2) 2
- 3) $-\frac{1}{2}$
- 4) $\frac{1}{2}$

281 In interval notation, the set of all real numbers greater than -6 and less than or equal to 14 is represented by

- 1) $(-6, 14)$
- 2) $[-6, 14)$
- 3) $(-6, 14]$
- 4) $[-6, 14]$

282 The algebraic expression $\frac{x-2}{x^2-9}$ is undefined when

- x is
- 1) 0
 - 2) 2
 - 3) 3
 - 4) 9

Integrated Algebra Multiple Choice Regents Exam Questions

www.jmap.org

283 Which equation has roots of -3 and 5 ?

- 1) $x^2 + 2x - 15 = 0$
- 2) $x^2 - 2x - 15 = 0$
- 3) $x^2 + 2x + 15 = 0$
- 4) $x^2 - 2x + 15 = 0$

284 A cylinder has a diameter of 10 inches and a height of 2.3 inches. What is the volume of this cylinder, to the nearest tenth of a cubic inch?

- 1) 72.3
- 2) 83.1
- 3) 180.6
- 4) 722.6

285 Given: $A = \{3, 6, 9, 12, 15\}$

$$B = \{2, 4, 6, 8, 10, 12\}$$

What is the union of sets A and B ?

- 1) $\{6\}$
- 2) $\{6, 12\}$
- 3) $\{2, 3, 4, 8, 9, 10, 15\}$
- 4) $\{2, 3, 4, 6, 8, 9, 10, 12, 15\}$

286 Which relation is a function?

- 1) $\left\{ \left(\frac{3}{4}, 0 \right), (0, 1), \left(\frac{3}{4}, 2 \right) \right\}$
- 2) $\left\{ (-2, 2), \left(-\frac{1}{2}, 1 \right), (-2, 4) \right\}$
- 3) $\{(-1, 4), (0, 5), (0, 4)\}$
- 4) $\{(2, 1), (4, 3), (6, 5)\}$

287 How many different ways can five books be arranged on a shelf?

- 1) 5
- 2) 15
- 3) 25
- 4) 120

288 What is the value of the y -coordinate of the solution to the system of equations $2x + y = 8$ and $x - 3y = -3$?

- 1) -2
- 2) 2
- 3) 3
- 4) -3

289 The diagram below shows right triangle ABC .

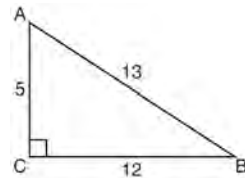

Which ratio represents the tangent of $\angle ABC$?

- 1) $\frac{5}{13}$
- 2) $\frac{5}{12}$
- 3) $\frac{12}{13}$
- 4) $\frac{12}{5}$

Integrated Algebra Multiple Choice Regents Exam Questions

www.jmap.org

- 290 What is the result when $2x^2 + 3xy - 6$ is subtracted from $x^2 - 7xy + 2$?
- 1) $-x^2 - 10xy + 8$
 - 2) $x^2 + 10xy - 8$
 - 3) $-x^2 - 4xy - 4$
 - 4) $x^2 - 4xy - 4$

- 291 The spinner shown in the diagram below is divided into six equal sections.

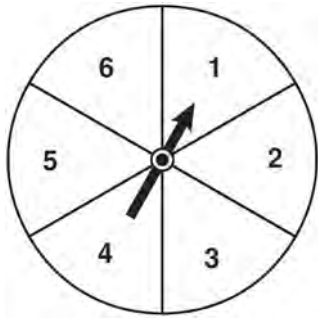

Which outcome is *least* likely to occur on a single spin?

- 1) an odd number
 - 2) a prime number
 - 3) a perfect square
 - 4) a number divisible by 2
- 292 What is $\frac{7}{12x} - \frac{y}{6x^2}$ expressed in simplest form?

- 1) $\frac{7-y}{6x}$
- 2) $\frac{7-y}{12x-6x^2}$
- 3) $-\frac{7y}{12x^2}$
- 4) $\frac{7x-2y}{12x^2}$

- 293 The number of calories burned while jogging varies directly with the number of minutes spent jogging. If George burns 150 calories by jogging for 20 minutes, how many calories does he burn by jogging for 30 minutes?

- 1) 100
- 2) 180
- 3) 200
- 4) 225

- 294 Which set represents the intersection of sets A, B, and C shown in the diagram below?

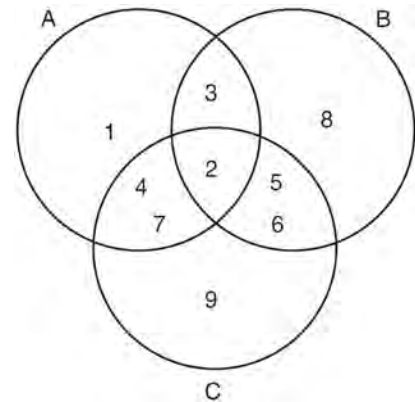

- 1) $\{3, 4, 5, 6, 7\}$
- 2) $\{2\}$
- 3) $\{2, 3, 4, 5, 6, 7\}$
- 4) $\{1, 2, 3, 4, 5, 6, 7, 8, 9\}$

- 295 What is an equation of the axis of symmetry of the parabola represented by $y = -x^2 + 6x - 4$?

- 1) $x = 3$
- 2) $y = 3$
- 3) $x = 6$
- 4) $y = 6$

296 The diagram below shows the graph of $y = -x^2 - c$.

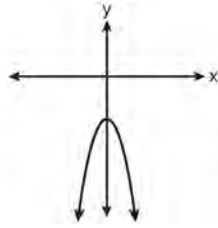

Which diagram shows the graph of $y = x^2 - c$?

- 1)
- 2)
- 3)
- 4)

297 Which scatter plot shows the relationship between x and y if x represents a student score on a test and y represents the number of incorrect answers a student received on the same test?

- 1)
- 2)
- 3)
- 4)

Integrated Algebra Multiple Choice Regents Exam Questions

www.jmap.org

- 298 Factored completely, the expression $3x^2 - 3x - 18$ is equivalent to
- 1) $3(x^2 - x - 6)$
 - 2) $3(x - 3)(x + 2)$
 - 3) $(3x - 9)(x + 2)$
 - 4) $(3x + 6)(x - 3)$
- 299 Melissa graphed the equation $y = x^2$ and Dave graphed the equation $y = -3x^2$ on the same coordinate grid. What is the relationship between the graphs that Melissa and Dave drew?
- 1) Dave's graph is wider and opens in the opposite direction from Melissa's graph.
 - 2) Dave's graph is narrower and opens in the opposite direction from Melissa's graph.
 - 3) Dave's graph is wider and is three units below Melissa's graph.
 - 4) Dave's graph is narrower and is three units to the left of Melissa's graph.
- 300 The height, y , of a ball tossed into the air can be represented by the equation $y = -x^2 + 10x + 3$, where x is the elapsed time. What is the equation of the axis of symmetry of this parabola?
- 1) $y = 5$
 - 2) $y = -5$
 - 3) $x = 5$
 - 4) $x = -5$
- 301 In a recent town election, 1,860 people voted for either candidate A or candidate B for the position of supervisor. If candidate A received 55% of the votes, how many votes did candidate B receive?
- 1) 186
 - 2) 837
 - 3) 1,023
 - 4) 1,805
- 302 What is the slope of the line whose equation is $3x - 7y = 9$?
- 1) $-\frac{3}{7}$
 - 2) $\frac{3}{7}$
 - 3) $-\frac{7}{3}$
 - 4) $\frac{7}{3}$
- 303 What is the solution of the system of equations $2x - 5y = 11$ and $-2x + 3y = -9$?
- 1) $(-3, -1)$
 - 2) $(-1, 3)$
 - 3) $(3, -1)$
 - 4) $(3, 1)$
- 304 Which expression is equivalent to $3^3 \cdot 3^4$?
- 1) 9^{12}
 - 2) 9^7
 - 3) 3^{12}
 - 4) 3^7
- 305 Given: $U = \{1, 2, 3, 4, 5, 6, 7, 8\}$
 $B = \{2, 3, 5, 6\}$
 Set B is a subset of set U . What is the complement of set B ?
- 1) $\{ \}$
 - 2) $\{2, 3, 5, 6\}$
 - 3) $\{1, 4, 7, 8\}$
 - 4) $\{1, 2, 3, 4, 5, 6, 7, 8\}$

Integrated Algebra Multiple Choice Regents Exam Questions

www.jmap.org

- 306 A garden is in the shape of an isosceles trapezoid and a semicircle, as shown in the diagram below. A fence will be put around the perimeter of the entire garden.

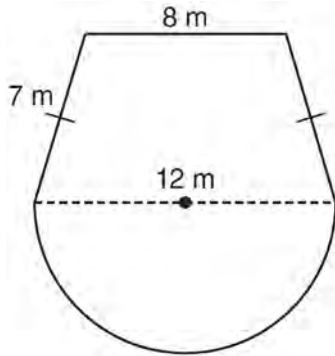

Which expression represents the length of fencing, in meters, that will be needed?

- 1) $22 + 6\pi$
 - 2) $22 + 12\pi$
 - 3) $15 + 6\pi$
 - 4) $15 + 12\pi$
- 307 The dimensions of a rectangle are measured to be 12.2 inches by 11.8 inches. The actual dimensions are 12.3 inches by 11.9 inches. What is the relative error, to the *nearest ten-thousandth*, in calculating the area of the rectangle?
- 1) 0.0168
 - 2) 0.0167
 - 3) 0.0165
 - 4) 0.0164
- 308 Which point is on the line $4y - 2x = 0$?
- 1) $(-2, -1)$
 - 2) $(-2, 1)$
 - 3) $(-1, -2)$
 - 4) $(1, 2)$

- 309 An 8-foot rope is tied from the top of a pole to a stake in the ground, as shown in the diagram below.

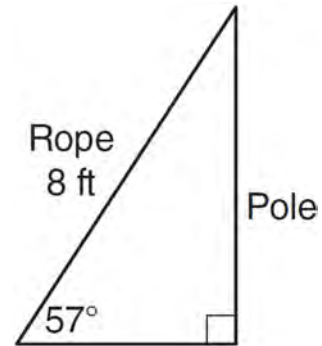

If the rope forms a 57° angle with the ground, what is the height of the pole, to the *nearest tenth of a foot*?

- 1) 4.4
 - 2) 6.7
 - 3) 9.5
 - 4) 12.3
- 310 What is the sum of $\frac{3}{2x}$ and $\frac{7}{4x}$?
- 1) $\frac{21}{8x^2}$
 - 2) $\frac{13}{4x}$
 - 3) $\frac{10}{6x}$
 - 4) $\frac{13}{8x}$

Integrated Algebra Multiple Choice Regents Exam Questions

www.jmap.org

311 The expression $\sqrt{72} - 3\sqrt{2}$ written in simplest radical form is

- 1) $5\sqrt{2}$
- 2) $3\sqrt{6}$
- 3) $3\sqrt{2}$
- 4) $\sqrt{6}$

312 Roger is having a picnic for 78 guests. He plans to serve each guest at least one hot dog. If each package, p , contains eight hot dogs, which inequality could be used to determine how many packages of hot dogs Roger will need to buy?

- 1) $p \geq 78$
- 2) $8p \geq 78$
- 3) $8 + p \geq 78$
- 4) $78 - p \geq 8$

313 What is an equation of the line that passes through the points (1,3) and (8,5)?

- 1) $y + 1 = \frac{2}{7}(x + 3)$
- 2) $y - 5 = \frac{2}{7}(x - 8)$
- 3) $y - 1 = \frac{2}{7}(x + 3)$
- 4) $y + 5 = \frac{2}{7}(x - 8)$

314 How many different three-letter arrangements can be formed using the letters in the word *ABSOLUTE* if each letter is used only once?

- 1) 56
- 2) 112
- 3) 168
- 4) 336

315 When 36 is subtracted from the square of a number, the result is five times the number. What is the positive solution?

- 1) 9
- 2) 6
- 3) 3
- 4) 4

316 In a science fiction novel, the main character found a mysterious rock that decreased in size each day. The table below shows the part of the rock that remained at noon on successive days.

Day	Fractional Part of the Rock Remaining
1	1
2	$\frac{1}{2}$
3	$\frac{1}{4}$
4	$\frac{1}{8}$

Which fractional part of the rock will remain at noon on day 7?

- 1) $\frac{1}{128}$
- 2) $\frac{1}{64}$
- 3) $\frac{1}{14}$
- 4) $\frac{1}{12}$

Integrated Algebra Multiple Choice Regents Exam Questions

www.jmap.org

- 317 The quotient of (9.2×10^6) and (2.3×10^2) expressed in scientific notation is
- 1) 4,000
 - 2) 40,000
 - 3) 4×10^3
 - 4) 4×10^4

- 318 What is the slope of the line passing through the points $(-2,4)$ and $(3,6)$?
- 1) $-\frac{5}{2}$
 - 2) $-\frac{2}{5}$
 - 3) $\frac{2}{5}$
 - 4) $\frac{5}{2}$

- 319 The rectangle shown below has a diagonal of 18.4 cm and a width of 7 cm.

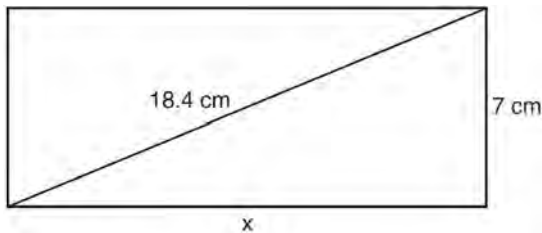

To the *nearest centimeter*, what is the length, x , of the rectangle?

- 1) 11
- 2) 17
- 3) 20
- 4) 25

- 320 The legs of an isosceles right triangle each measure 10 inches. What is the length of the hypotenuse of this triangle, to the *nearest tenth of an inch*?
- 1) 6.3
 - 2) 7.1
 - 3) 14.1
 - 4) 17.1

- 321 Given: $X = \{1,2,3,4\}$
 $Y = \{2,3,4,5\}$
 $Z = \{3,4,5,6\}$

What is the intersection of sets X , Y , and Z ?

- 1) $\{3,4\}$
- 2) $\{2,3,4\}$
- 3) $\{3,4,5\}$
- 4) $\{1,2,3,4,5,6\}$

- 322 Which ordered pair is in the solution set of the following system of linear inequalities?

$$y < 2x + 2$$

$$y \geq -x - 1$$

- 1) $(0,3)$
- 2) $(2,0)$
- 3) $(-1,0)$
- 4) $(-1,-4)$

- 323 The length of a rectangle is 3 inches more than its width. The area of the rectangle is 40 square inches. What is the length, in inches, of the rectangle?

- 1) 5
- 2) 8
- 3) 8.5
- 4) 11.5

Integrated Algebra Multiple Choice Regents Exam Questions

www.jmap.org

- 324 How many different four-letter arrangements are possible with the letters G, A, R, D, E, N if each letter may be used only once?
- 1) 15
 - 2) 24
 - 3) 360
 - 4) 720
- 325 Jack wants to replace the flooring in his rectangular kitchen. He calculates the area of the floor to be 12.8 square meters. The actual area of the floor is 13.5 square meters. What is the relative error in calculating the area of the floor, to the *nearest thousandth*?
- 1) 0.051
 - 2) 0.052
 - 3) 0.054
 - 4) 0.055
- 326 The probability that it will snow on Sunday is $\frac{3}{5}$. The probability that it will snow on both Sunday and Monday is $\frac{3}{10}$. What is the probability that it will snow on Monday, if it snowed on Sunday?
- 1) $\frac{9}{50}$
 - 2) 2
 - 3) $\frac{1}{2}$
 - 4) $\frac{9}{10}$
- 327 Which set of ordered pairs represents a function?
- 1) $\{(0,4), (2,4), (2,5)\}$
 - 2) $\{(6,0), (5,0), (4,0)\}$
 - 3) $\{(4,1), (6,2), (6,3), (5,0)\}$
 - 4) $\{(0,4), (1,4), (0,5), (1,5)\}$
- 328 What is the sum of $\frac{-x+7}{2x+4}$ and $\frac{2x+5}{2x+4}$?
- 1) $\frac{x+12}{2x+4}$
 - 2) $\frac{3x+12}{2x+4}$
 - 3) $\frac{x+12}{4x+8}$
 - 4) $\frac{3x+12}{4x+8}$
- 329 What is $3\sqrt{250}$ expressed in simplest radical form?
- 1) $5\sqrt{10}$
 - 2) $8\sqrt{10}$
 - 3) $15\sqrt{10}$
 - 4) $75\sqrt{10}$
- 330 What is $\frac{2+x}{5x} - \frac{x-2}{5x}$ expressed in simplest form?
- 1) 0
 - 2) $\frac{2}{5}$
 - 3) $\frac{4}{5x}$
 - 4) $\frac{2x+4}{5x}$
- 331 For which set of values of x is the algebraic expression $\frac{x^2-16}{x^2-4x-12}$ undefined?
- 1) $\{-6, 2\}$
 - 2) $\{-4, 3\}$
 - 3) $\{-4, 4\}$
 - 4) $\{-2, 6\}$

Integrated Algebra Multiple Choice Regents Exam Questions

www.jmap.org

332 Which value of x is the solution of the equation

$$\frac{2}{3}x + \frac{1}{2} = \frac{5}{6}?$$

- 1) $\frac{1}{2}$
- 2) 2
- 3) $\frac{2}{3}$
- 4) $\frac{3}{2}$

333 Which ordered pair is a solution of the system of equations shown in the graph below?

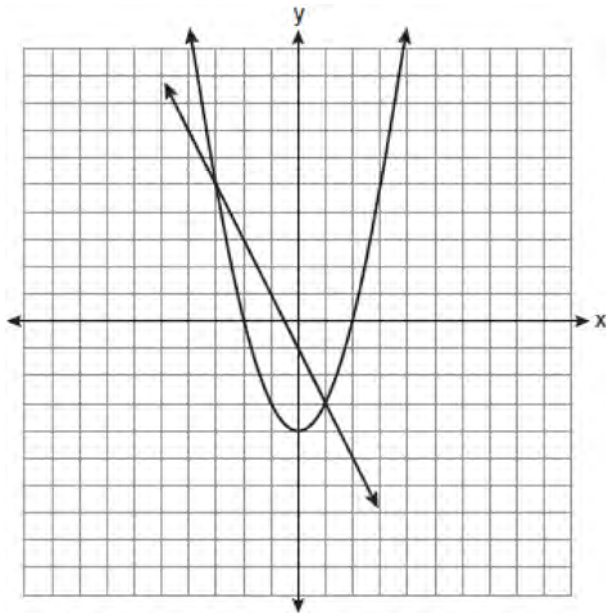

- 1) $(-3, 1)$
- 2) $(-3, 5)$
- 3) $(0, -1)$
- 4) $(0, -4)$

334 Which relation represents a function?

- 1) $\{(0, 3), (2, 4), (0, 6)\}$
- 2) $\{(-7, 5), (-7, 1), (-10, 3), (-4, 3)\}$
- 3) $\{(2, 0), (6, 2), (6, -2)\}$
- 4) $\{(-6, 5), (-3, 2), (1, 2), (6, 5)\}$

335 The members of the senior class are planning a dance. They use the equation $r = pn$ to determine the total receipts. What is n expressed in terms of r and p ?

- 1) $n = r + p$
- 2) $n = r - p$
- 3) $n = \frac{p}{r}$
- 4) $n = \frac{r}{p}$

336 What is the solution of the system of equations $c + 3d = 8$ and $c = 4d - 6$?

- 1) $c = -14, d = -2$
- 2) $c = -2, d = 2$
- 3) $c = 2, d = 2$
- 4) $c = 14, d = -2$

337 The value, y , of a \$15,000 investment over x years

is represented by the equation $y = 15000(1.2)^{\frac{x}{3}}$.

What is the profit (interest) on a 6-year investment?

- 1) \$6,600
- 2) \$10,799
- 3) \$21,600
- 4) \$25,799

Integrated Algebra Multiple Choice Regents Exam Questions

www.jmap.org

338 Which equation represents a line parallel to the y-axis?

- 1) $y = x$
- 2) $y = 3$
- 3) $x = -y$
- 4) $x = -4$

339 What is the slope of the line that passes through the points (3,5) and (-2,2)?

- 1) $\frac{1}{5}$
- 2) $\frac{3}{5}$
- 3) $\frac{5}{3}$
- 4) 5

340 What is the equation of the axis of symmetry of the parabola shown in the diagram below?

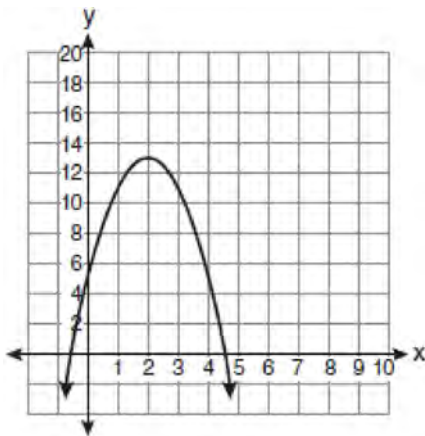

- 1) $x = -0.5$
- 2) $x = 2$
- 3) $x = 4.5$
- 4) $x = 13$

341 The scatter plot below represents the relationship between the number of peanuts a student eats and the student's bowling score.

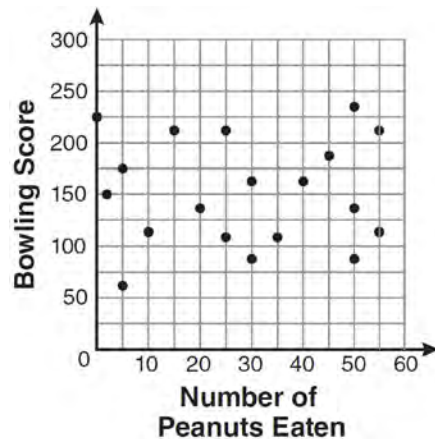

Which conclusion about the scatter plot is valid?

- 1) There is almost no relationship between eating peanuts and bowling score.
- 2) Students who eat more peanuts have higher bowling scores.
- 3) Students who eat more peanuts have lower bowling scores.
- 4) No bowlers eat peanuts.

342 The expression $6\sqrt{50} + 6\sqrt{2}$ written in simplest radical form is

- 1) $6\sqrt{52}$
- 2) $12\sqrt{52}$
- 3) $17\sqrt{2}$
- 4) $36\sqrt{2}$

343 Which notation describes {1,2,3}?

- 1) $\{x \mid 1 \leq x < 3, \text{ where } x \text{ is an integer}\}$
- 2) $\{x \mid 0 < x \leq 3, \text{ where } x \text{ is an integer}\}$
- 3) $\{x \mid 1 < x < 3, \text{ where } x \text{ is an integer}\}$
- 4) $\{x \mid 0 \leq x \leq 3, \text{ where } x \text{ is an integer}\}$

344 Which table does *not* show bivariate data?

1)

Height (inches)	Weight (pounds)
39	50
48	70
60	90

2)

Gallons	Miles Driven
15	300
20	400
25	500

3)

Quiz Average	Frequency
70	12
80	15
90	6

4)

Speed (mph)	Distance (miles)
40	80
50	120
55	150

345 What is $3\sqrt{2} + \sqrt{8}$ expressed in simplest radical form?

- 1) $3\sqrt{10}$
- 2) $3\sqrt{16}$
- 3) $5\sqrt{2}$
- 4) $7\sqrt{2}$

346 Which graph could be used to find the solution of the system of equations $y = 2x + 6$ and $y = x^2 + 4x + 3$?

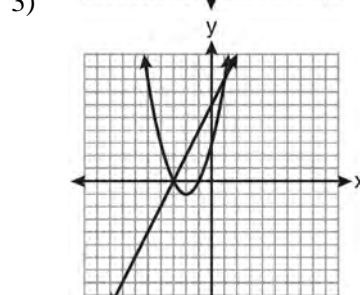
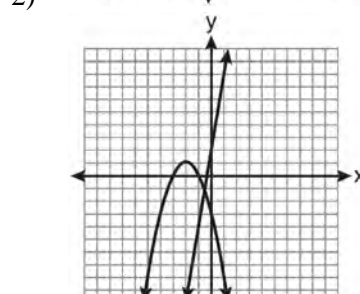
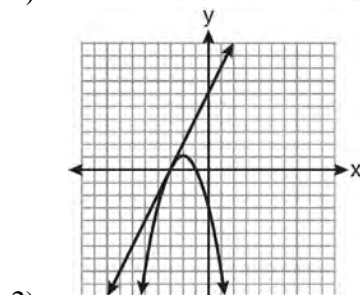
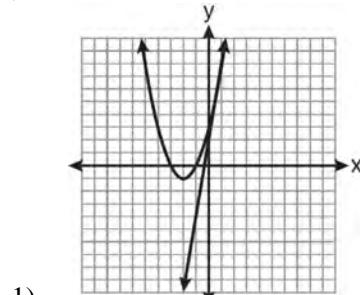

- 347 The figure shown below is composed of two rectangles and a quarter circle.

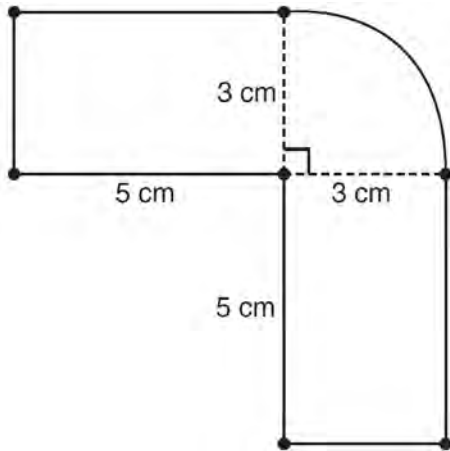

What is the area of this figure, to the nearest square centimeter?

- 1) 33
 - 2) 37
 - 3) 44
 - 4) 58
- 348 How many different sandwiches consisting of one type of cheese, one condiment, and one bread choice can be prepared from five types of cheese, two condiments, and three bread choices?

- 1) 10
- 2) 13
- 3) 15
- 4) 30

- 349 The expression $\frac{(10w^3)^2}{5w}$ is equivalent to

- 1) $2w^5$
- 2) $2w^8$
- 3) $20w^5$
- 4) $20w^8$

- 350 What are the vertex and axis of symmetry of the parabola shown in the diagram below?

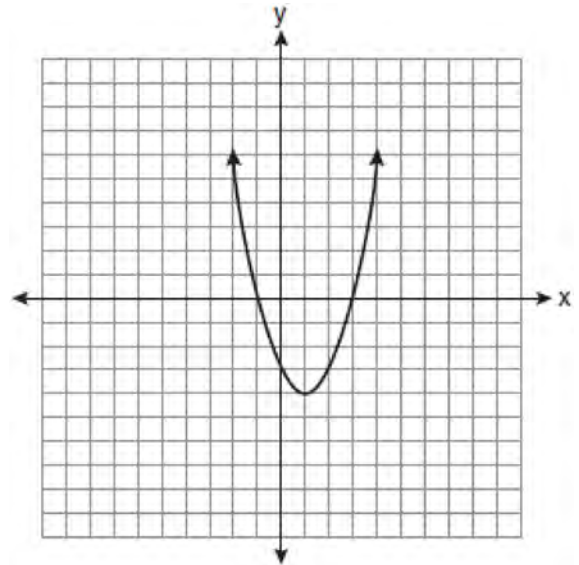

- 1) vertex: $(1, -4)$; axis of symmetry: $x = 1$
 - 2) vertex: $(1, -4)$; axis of symmetry: $x = -4$
 - 3) vertex: $(-4, 1)$; axis of symmetry: $x = 1$
 - 4) vertex: $(-4, 1)$; axis of symmetry: $x = -4$
- 351 If Ann correctly factors an expression that is the difference of two perfect squares, her factors could be

- 1) $(2x + y)(x - 2y)$
- 2) $(2x + 3y)(2x - 3y)$
- 3) $(x - 4)(x - 4)$
- 4) $(2y - 5)(y - 5)$

- 352 An example of an algebraic expression is

- 1) $\frac{2x + 3}{7} = \frac{13}{x}$
- 2) $(2x + 1)(x - 7)$
- 3) $4x - 1 = 4$
- 4) $x = 2$

Integrated Algebra Multiple Choice Regents Exam Questions

www.jmap.org

- 353 Which equation illustrates the associative property?
- 1) $x + y + z = x + y + z$
 - 2) $x(y + z) = xy + xz$
 - 3) $x + y + z = z + y + x$
 - 4) $(x + y) + z = x + (y + z)$
- 354 Which equation represents the line that passes through the point (1,5) and has a slope of -2 ?
- 1) $y = -2x + 7$
 - 2) $y = -2x + 11$
 - 3) $y = 2x - 9$
 - 4) $y = 2x + 3$
- 355 Which ordered pair is a solution to the system of equations $y = x + 3$ and $y = x^2 - x$?
- 1) (6,9)
 - 2) (3,6)
 - 3) (3,-1)
 - 4) (2,5)
- 356 Which expression represents $\frac{12x^3 - 6x^2 + 2x}{2x}$ in simplest form?
- 1) $6x^2 - 3x$
 - 2) $10x^2 - 4x$
 - 3) $6x^2 - 3x + 1$
 - 4) $10x^2 - 4x + 1$
- 357 Maria has a set of 10 index cards labeled with the digits 0 through 9. She puts them in a bag and selects one at random. The outcome that is most likely to occur is selecting
- 1) an odd number
 - 2) a prime number
 - 3) a number that is at most 5
 - 4) a number that is divisible by 3
- 358 Which interval notation represents the set of all real numbers greater than 2 and less than or equal to 20?
- 1) (2,20)
 - 2) (2,20]
 - 3) [2,20)
 - 4) [2,20]
- 359 The value of the expression $-|a - b|$ when $a = 7$ and $b = -3$ is
- 1) -10
 - 2) 10
 - 3) -4
 - 4) 4
- 360 What is the value of the expression $(a^3 + b^0)^2$ when $a = -2$ and $b = 4$?
- 1) 64
 - 2) 49
 - 3) -49
 - 4) -64

Integrated Algebra Multiple Choice Regents Exam Questions

www.jmap.org

361 Which situation describes a correlation that is *not* a causal relationship?

- 1) the length of the edge of a cube and the volume of the cube
- 2) the distance traveled and the time spent driving
- 3) the age of a child and the number of siblings the child has
- 4) the number of classes taught in a school and the number of teachers employed

362 What are the vertex and the axis of symmetry of the parabola shown in the graph below?

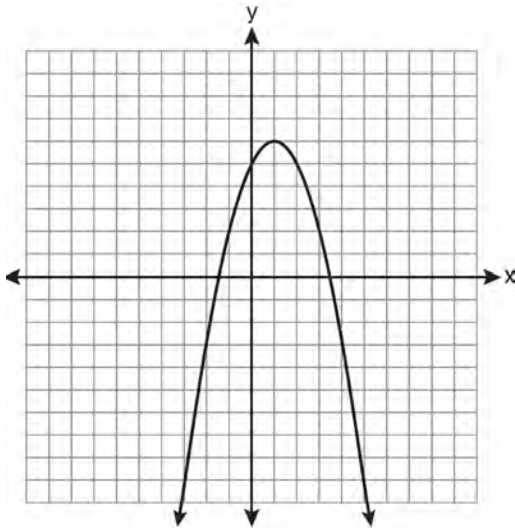

- 1) vertex: (1,6); axis of symmetry: $y = 1$
- 2) vertex: (1,6); axis of symmetry: $x = 1$
- 3) vertex: (6,1); axis of symmetry: $y = 1$
- 4) vertex: (6,1); axis of symmetry: $x = 1$

363 Which graph represents an exponential equation?

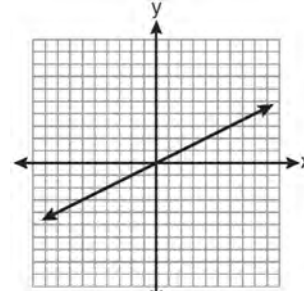

1)

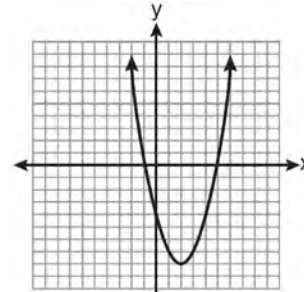

2)

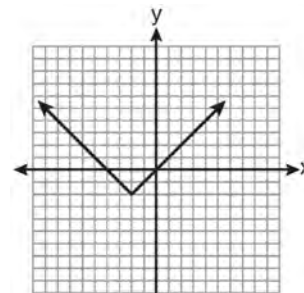

3)

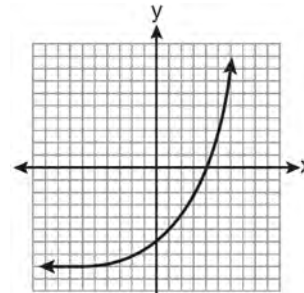

4)

Integrated Algebra Multiple Choice Regents Exam Questions

www.jmap.org

- 364 The school store did a study comparing the cost of a sweatshirt with the number of sweatshirts sold. The price was changed several times and the numbers of sweatshirts sold were recorded. The data are shown in the table below.

Cost of Sweatshirt	\$10	\$25	\$15	\$20	\$5
Number Sold	9	6	15	11	14

Which scatter plot represents the data?

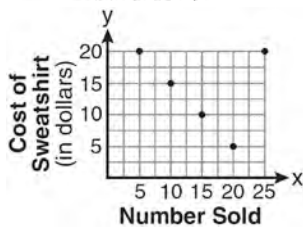
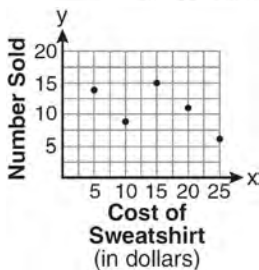
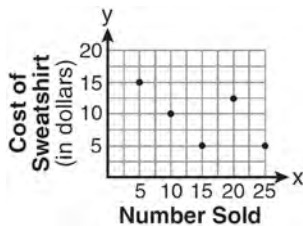
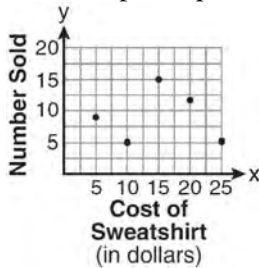

- 365 Which verbal expression is represented by $\frac{1}{2}(n - 3)$?
- 1) one-half n decreased by 3
 - 2) one-half n subtracted from 3
 - 3) the difference of one-half n and 3
 - 4) one-half the difference of n and 3

- 366 Which expression represents $\frac{-14a^2c^8}{7a^3c^2}$ in simplest form?
- 1) $-2ac^4$
 - 2) $-2ac^6$
 - 3) $\frac{-2c^4}{a}$
 - 4) $\frac{-2c^6}{a}$

- 367 Which verbal expression can be represented by $2(x - 5)$?
- 1) 5 less than 2 times x
 - 2) 2 multiplied by x less than 5
 - 3) twice the difference of x and 5
 - 4) the product of 2 and x , decreased by 5

- 368 An example of an algebraic expression is
- 1) $x + 2$
 - 2) $y = x + 2$
 - 3) $y < x + 2$
 - 4) $y = x^2 + 2x$

Integrated Algebra Multiple Choice Regents Exam Questions

www.jmap.org

- 369 Four hundred licensed drivers participated in the math club's survey on driving habits. The table below shows the number of drivers surveyed in each age group.

Ages of People in Survey on Driving Habits

Age Group	Number of Drivers
16–25	150
26–35	129
36–45	33
46–55	57
56–65	31

Which statement best describes a conclusion based on the data in the table?

- 1) It may be biased because no one younger than 16 was surveyed.
 - 2) It would be fair because many different age groups were surveyed.
 - 3) It would be fair because the survey was conducted by the math club students.
 - 4) It may be biased because the majority of drivers surveyed were in the younger age intervals.
- 370 What is the range of the data represented in the box-and-whisker plot shown below?

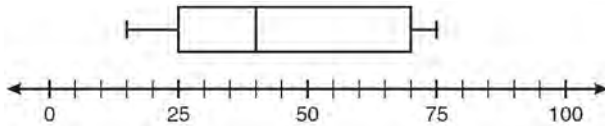

- 1) 40
- 2) 45
- 3) 60
- 4) 100

- 371 The end of a dog's leash is attached to the top of a 5-foot-tall fence post, as shown in the diagram below. The dog is 7 feet away from the base of the fence post.

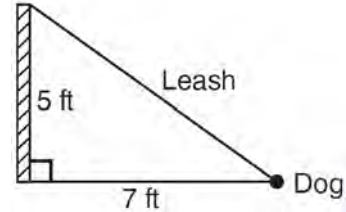

How long is the leash, to the *nearest tenth of a foot*?

- 1) 4.9
 - 2) 8.6
 - 3) 9.0
 - 4) 12.0
- 372 Sam's grades on eleven chemistry tests were 90, 85, 76, 63, 94, 89, 81, 76, 78, 69, and 97. Which statement is true about the measures of central tendency?
- 1) mean > mode
 - 2) mean < median
 - 3) mode > median
 - 4) median = mean

- 373 Which phrase best describes the relationship between the number of miles driven and the amount of gasoline used?

- 1) causal, but not correlated
- 2) correlated, but not causal
- 3) both correlated and causal
- 4) neither correlated nor causal

Integrated Algebra Multiple Choice Regents Exam Questions

www.jmap.org

- 374 The graph of the equation $y = |x|$ is shown in the diagram below.

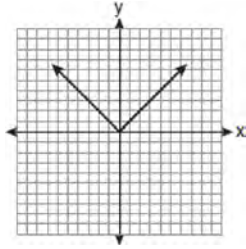

Which diagram could represent a graph of the equation $y = a|x|$ when $-1 < a < 0$?

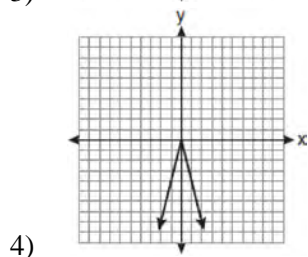
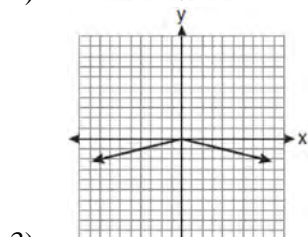
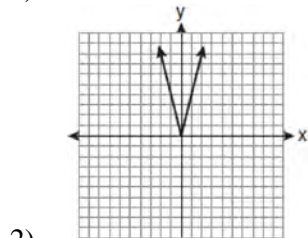
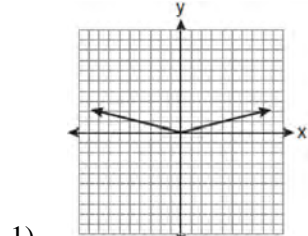

- 375 Which equation represents a line parallel to the y -axis?

- 1) $x = y$
- 2) $x = 4$
- 3) $y = 4$
- 4) $y = x + 4$

- 376 When $5x + 4y$ is subtracted from $5x - 4y$, the difference is

- 1) 0
- 2) $10x$
- 3) $8y$
- 4) $-8y$

- 377 Based on the box-and-whisker plot below, which statement is *false*?

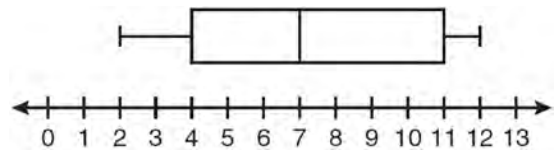

- 1) The median is 7.
- 2) The range is 12.
- 3) The first quartile is 4.
- 4) The third quartile is 11.

- 378 Josh and Mae work at a concession stand. They each earn \$8 per hour. Josh worked three hours more than Mae. If Josh and Mae earned a total of \$120, how many hours did Josh work?

- 1) 6
- 2) 9
- 3) 12
- 4) 15

Integrated Algebra Multiple Choice Regents Exam Questions

www.jmap.org

- 379 Debbie solved the linear equation $3(x + 4) - 2 = 16$ as follows:

[Line 1] $3(x + 4) - 2 = 16$

[Line 2] $3(x + 4) = 18$

[Line 3] $3x + 4 = 18$

[Line 4] $3x = 14$

[Line 5] $x = 4\frac{2}{3}$

She made an error between lines

- 1) 1 and 2
- 2) 2 and 3
- 3) 3 and 4
- 4) 4 and 5

- 380 In right triangle ABC shown below, $AB = 18.3$ and $BC = 11.2$.

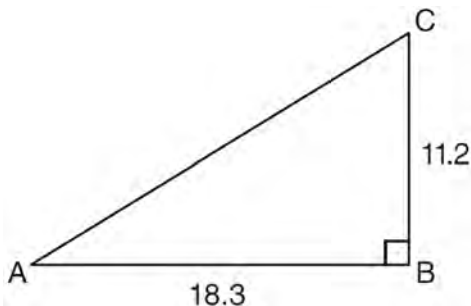

What is the measure of $\angle A$, to the nearest tenth of a degree?

- 1) 31.5
- 2) 37.7
- 3) 52.3
- 4) 58.5

- 381 The width of a rectangle is 3 less than twice the length, x . If the area of the rectangle is 43 square feet, which equation can be used to find the length, in feet?

- 1) $2x(x - 3) = 43$
- 2) $x(3 - 2x) = 43$
- 3) $2x + 2(2x - 3) = 43$
- 4) $x(2x - 3) = 43$

- 382 A hiker walked 12.8 miles from 9:00 a.m. to noon. He walked an additional 17.2 miles from 1:00 p.m. to 6:00 p.m. What is his average rate for the entire walk, in miles per hour?

- 1) 3.75
- 2) 3.86
- 3) 4.27
- 4) 7.71

- 383 When $a^3 - 4a$ is factored completely, the result is

- 1) $(a - 2)(a + 2)$
- 2) $a(a - 2)(a + 2)$
- 3) $a^2(a - 4)$
- 4) $a(a - 2)^2$

- 384 Which quadrant will be completely shaded in the graph of the inequality $y \leq 2x$?

- 1) Quadrant I
- 2) Quadrant II
- 3) Quadrant III
- 4) Quadrant IV

Integrated Algebra Multiple Choice Regents Exam Questions

www.jmap.org

385 Tim ate four more cookies than Alice. Bob ate twice as many cookies as Tim. If x represents the number of cookies Alice ate, which expression represents the number of cookies Bob ate?

- 1) $2 + (x + 4)$
- 2) $2x + 4$
- 3) $2(x + 4)$
- 4) $4(x + 2)$

386 Which expression represents $\frac{x^2 - x - 6}{x^2 - 5x + 6}$ in simplest form?

- 1) $\frac{x + 2}{x - 2}$
- 2) $\frac{-x - 6}{-5x + 6}$
- 3) $\frac{1}{5}$
- 4) -1

387 Which equation represents a quadratic function?

- 1) $y = x + 2$
- 2) $y = |x + 2|$
- 3) $y = x^2$
- 4) $y = 2^x$

388 Michael is 25 years younger than his father. The sum of their ages is 53. What is Michael's age?

- 1) 14
- 2) 25
- 3) 28
- 4) 39

389 How many square inches of wrapping paper are needed to entirely cover a box that is 2 inches by 3 inches by 4 inches?

- 1) 18
- 2) 24
- 3) 26
- 4) 52

390 A spinner that is equally divided into eight numbered sectors is spun 20 times. The table below shows the number of times the arrow landed in each numbered sector.

Spinner Sector	Number of Times
1	2
2	3
3	2
4	3
5	4
6	2
7	3
8	1

Based on the table, what is the empirical probability that the spinner will land on a prime number on the next spin?

- 1) $\frac{9}{20}$
- 2) $\frac{11}{20}$
- 3) $\frac{12}{20}$
- 4) $\frac{14}{20}$

Integrated Algebra 2 Point Regents Exam Questions

- 391 The diagram below represents Joe's two fish tanks.

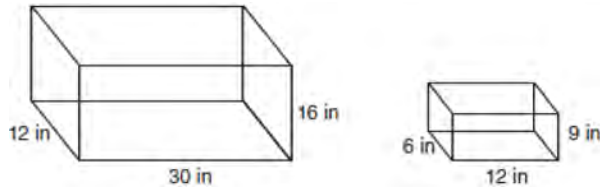

Joe's larger tank is completely filled with water. He takes water from it to completely fill the small tank. Determine how many cubic inches of water will remain in the larger tank.

- 392 Express $-3\sqrt{48}$ in simplest radical form.

- 393 Brianna is using the two spinners shown below to play her new board game. She spins the arrow on each spinner once. Brianna uses the first spinner to determine how many spaces to move. She uses the second spinner to determine whether her move from the first spinner will be forward or backward.



Find the probability that Brianna will move *fewer than* four spaces and *backward*.

- 394 In right triangle ABC , $AB = 20$, $AC = 12$, $BC = 16$, and $m\angle C = 90$. Find, to the *nearest degree*, the measure of $\angle A$.

- 395 Solve for g : $3 + 2g = 5g - 9$

- 396 Serena's garden is a rectangle joined with a semicircle, as shown in the diagram below. Line segment AB is the diameter of semicircle P . Serena wants to put a fence around her garden.

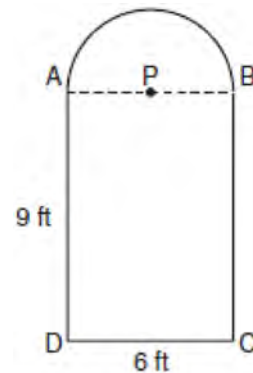

Calculate the length of fence Serena needs to the *nearest tenth of a foot*.

- 397 Twelve players make up a high school basketball team. The team jerseys are numbered 1 through 12. The players wearing the jerseys numbered 3, 6, 7, 8, and 11 are the only players who start a game. Using set notation, list the complement of this subset.

Integrated Algebra 2 Point Regents Exam Questions

www.jmap.org

398 Casey purchased a pack of assorted flower seeds and planted them in her garden. When the first 25 flowers bloomed, 11 were white, 5 were red, 3 were blue, and the rest were yellow. Find the empirical probability that a flower that blooms will be yellow.

399 Chad complained to his friend that he had five equations to solve for homework. Are all of the homework problems equations? Justify your answer.

Math Homework

1. $3x^2 \cdot 2x^4$
2. $5 - 2x = 3x$
3. $3(2x + 7)$
4. $7x^2 + 2x - 3x^2 - 9$
5. $\frac{2}{3} = \frac{x+2}{6}$

Name Chad

400 The area of a rectangle is represented by $x^2 - 5x - 24$. If the width of the rectangle is represented by $x - 8$, express the length of the rectangle as a binomial.

401 Alexis calculates the surface area of a gift box as 600 square inches. The actual surface area of the gift box is 592 square inches. Find the relative error of Alexis' calculation expressed as a decimal to the *nearest thousandth*.

402 Express $5\sqrt{72}$ in simplest radical form.

403 Perform the indicated operation: $-6(a - 7)$
State the name of the property used.

404 Maureen tracks the range of outdoor temperatures over three days. She records the following information.

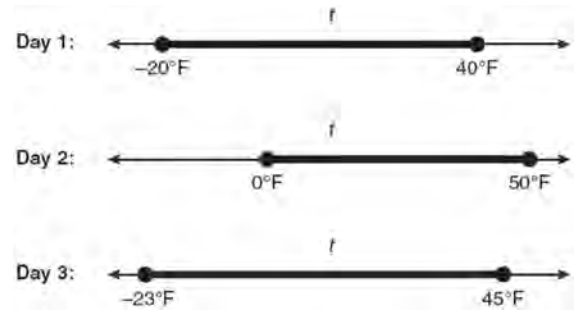

Express the intersection of the three sets as an inequality in terms of temperature, t .

Integrated Algebra 2 Point Regents Exam Questions

www.jmap.org

- 405 As shown in the diagram below, a ladder 5 feet long leans against a wall and makes an angle of 65° with the ground. Find, to the *nearest tenth of a foot*, the distance from the wall to the base of the ladder.

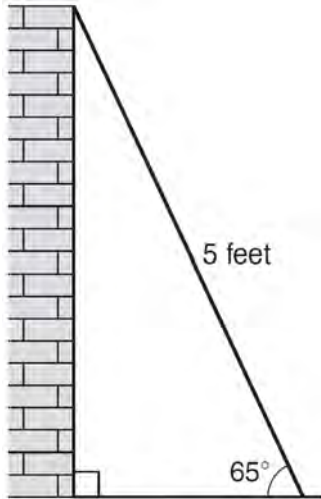

406 Simplify: $\frac{27k^5 m^8}{(4k^3)(9m^2)}$

- 407 Roberta needs ribbon for a craft project. The ribbon sells for \$3.75 per yard. Find the cost, in dollars, for 48 inches of the ribbon.

- 408 Angela wants to purchase carpeting for her living room. The dimensions of her living room are 12 feet by 12 feet. If carpeting is sold by the square yard, determine how many square yards of carpeting she must purchase.

3 feet = 1 yard
9 square feet = 1 square yard

- 409 Solve for c in terms of a and b : $bc + ac = ab$

410 Express in simplest form: $\frac{45a^4 b^3 - 90a^3 b}{15a^2 b}$

- 411 Mrs. Chen owns two pieces of property. The areas of the properties are 77,120 square feet and 33,500 square feet.

43,560 square feet = 1 acre

Find the total number of acres Mrs. Chen owns, to the *nearest hundredth of an acre*.

- 412 Clayton has three fair coins. Find the probability that he gets two tails and one head when he flips the three coins.

Integrated Algebra 2 Point Regents Exam Questions

www.jmap.org

413 Some books are laid on a desk. Two are English, three are mathematics, one is French, and four are social studies. Theresa selects an English book and Isabelle then selects a social studies book. Both girls take their selections to the library to read. If Truman then selects a book at random, what is the probability that he selects an English book?

414 Determine how many three-letter arrangements are possible with the letters $A, N, G, L,$ and E if no letter may be repeated.

415 A method for solving $5(x - 2) - 2(x - 5) = 9$ is shown below. Identify the property used to obtain each of the two indicated steps.

$$5(x - 2) - 2(x - 5) = 9$$

(1) $5x - 10 - 2x + 10 = 9$ (1) _____

(2) $5x - 2x - 10 + 10 = 9$ (2) _____

$$3x + 0 = 9$$

$$3x = 9$$

$$x = 3$$

416 Tom drove 290 miles from his college to home and used 23.2 gallons of gasoline. His sister, Ann, drove 225 miles from her college to home and used 15 gallons of gasoline. Whose vehicle had better gas mileage? Justify your answer.

417 State the equation of the axis of symmetry and the coordinates of the vertex of the parabola graphed below.

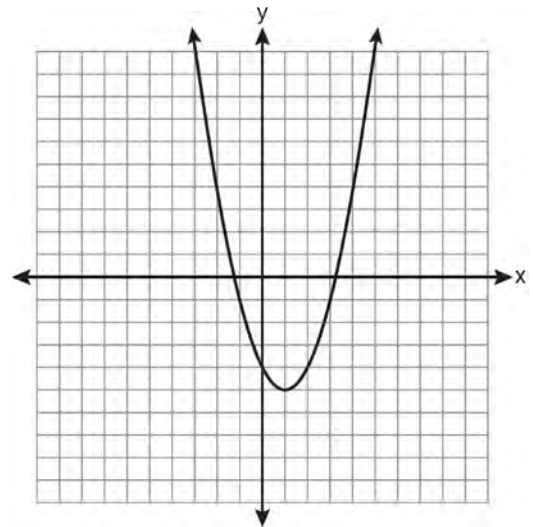

418 The table below represents the number of hours a student worked and the amount of money the student earned.

Number of Hours (h)	Dollars Earned (d)
8	\$50.00
15	\$93.75
19	\$118.75
30	\$187.50

Write an equation that represents the number of dollars, d , earned in terms of the number of hours, h , worked. Using this equation, determine the number of dollars the student would earn for working 40 hours.

Integrated Algebra 2 Point Regents Exam Questions

www.jmap.org

419 The length and width of the base of a rectangular prism are 5.5 cm and 3 cm. The height of the prism is 6.75 cm. Find the *exact* value of the surface area of the prism, in square centimeters.

420 Joseph typed a 1,200-word essay in 25 minutes. At this rate, determine how many words he can type in 45 minutes.

421 A communications company is building a 30-foot antenna to carry cell phone transmissions. As shown in the diagram below, a 50-foot wire from the top of the antenna to the ground is used to stabilize the antenna.

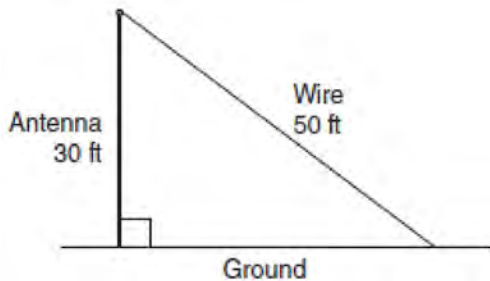

Find, to the *nearest degree*, the measure of the angle that the wire makes with the ground.

422 Jon is buying tickets for himself for two concerts. For the jazz concert, 4 tickets are available in the front row, and 32 tickets are available in the other rows. For the orchestra concert, 3 tickets are available in the front row, and 23 tickets are available in the other rows. Jon is randomly assigned one ticket for each concert. Determine the concert for which he is more likely to get a front-row ticket. Justify your answer.

423 Ms. Hopkins recorded her students' final exam scores in the frequency table below.

Interval	Tally	Frequency
61–70	###	5
71–80		4
81–90	###	9
91–100	###	6

On the grid below, construct a frequency histogram based on the table.

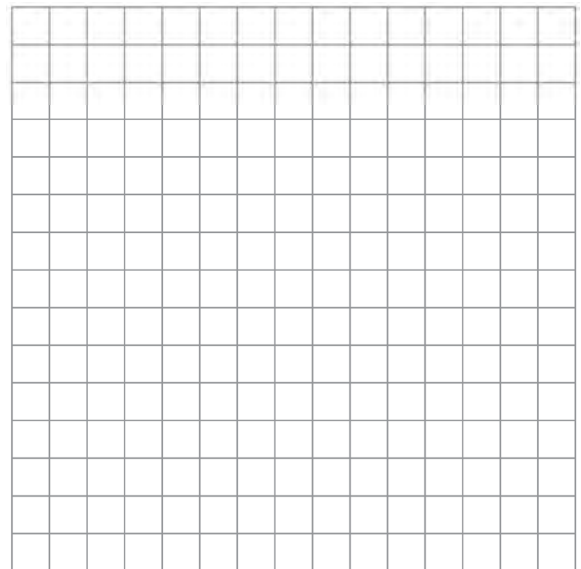

- 424 A window is made up of a single piece of glass in the shape of a semicircle and a rectangle, as shown in the diagram below. Tess is decorating for a party and wants to put a string of lights all the way around the outside edge of the window.

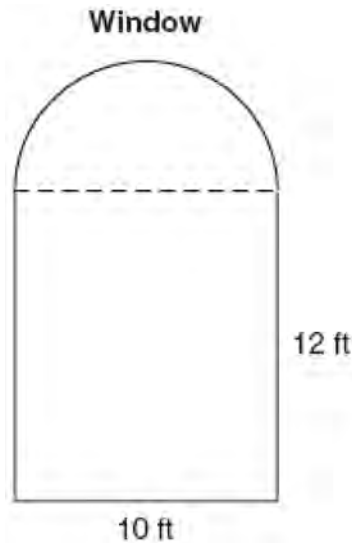

To the *nearest foot*, what is the length of the string of lights that Tess will need to decorate the window?

425 Express in simplest form: $\frac{x^2 - 1}{x^2 + 3x + 2}$

426 Factor completely: $4x^3 - 36x$

- 427 The square dart board shown below has a side that measures 40 inches. The shaded portion in the center is a square whose side is 15 inches. A dart thrown at the board is equally likely to land on any point on the dartboard.

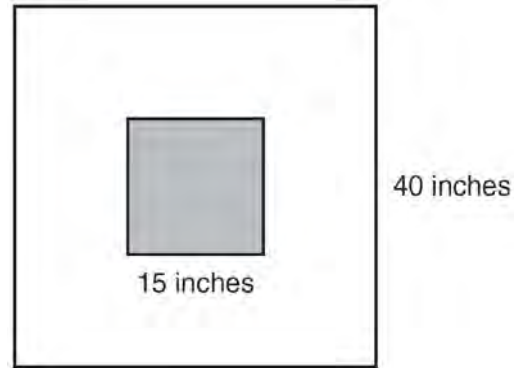

Find the probability that a dart hitting the board will *not* land in the shaded area.

- 428 In a game of ice hockey, the hockey puck took 0.8 second to travel 89 feet to the goal line. Determine the average speed of the puck in feet per second.

- 429 A designer created the logo shown below. The logo consists of a square and four quarter-circles of equal size.

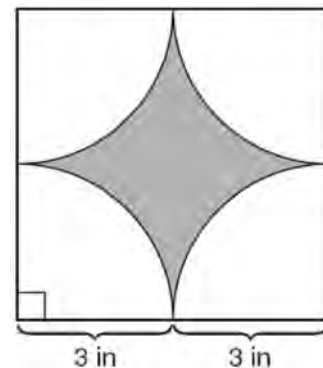

Express, in terms of π , the exact area, in square inches, of the shaded region.

Integrated Algebra 3 Point Regents Exam Questions

430 At the end of week one, a stock had increased in value from \$5.75 a share to \$7.50 a share. Find the percent of increase at the end of week one to the *nearest tenth of a percent*. At the end of week two, the same stock had decreased in value from \$7.50 to \$5.75. Is the percent of decrease at the end of week two the same as the percent of increase at the end of week one? Justify your answer.

431 Find the roots of the equation $x^2 = 30 - 13x$ algebraically.

432 On the set of axes below, draw the graph of $y = 2^x$ over the interval $-1 \leq x \leq 3$. Will this graph ever intersect the x -axis? Justify your answer.

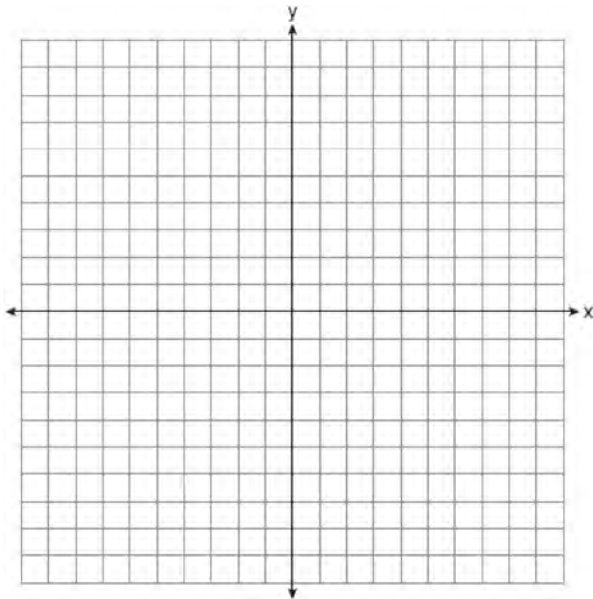

433 Ms. Mosher recorded the math test scores of six students in the table below.

Student	Student Score
Andrew	72
John	80
George	85
Amber	93
Betty	78
Roberto	80

Determine the mean of the student scores, to the *nearest tenth*. Determine the median of the student scores. Describe the effect on the mean and the median if Ms. Mosher adds 5 bonus points to each of the six students' scores.

434 A prom ticket at Smith High School is \$120. Tom is going to save money for the ticket by walking his neighbor's dog for \$15 per week. If Tom already has saved \$22, what is the minimum number of weeks Tom must walk the dog to earn enough to pay for the prom ticket?

435 Mr. Laub has three children: two girls (Sue and Karen) and one boy (David). After each meal, one child is chosen at random to wash dishes. If the same child can be chosen for both lunch and dinner, construct a tree diagram or list a sample space of all the possible outcomes of who will wash dishes after lunch and dinner on Saturday. Determine the probability that one boy and one girl will wash dishes after lunch and dinner on Saturday.

Integrated Algebra 3 Point Regents Exam Questions

www.jmap.org

436 Write an equation that represents the line that passes through the points (5,4) and (-5,0).

437 On the set of axes below, solve the following system of equations graphically. State the coordinates of the solution.

$$y = 4x - 1$$

$$2x + y = 5$$

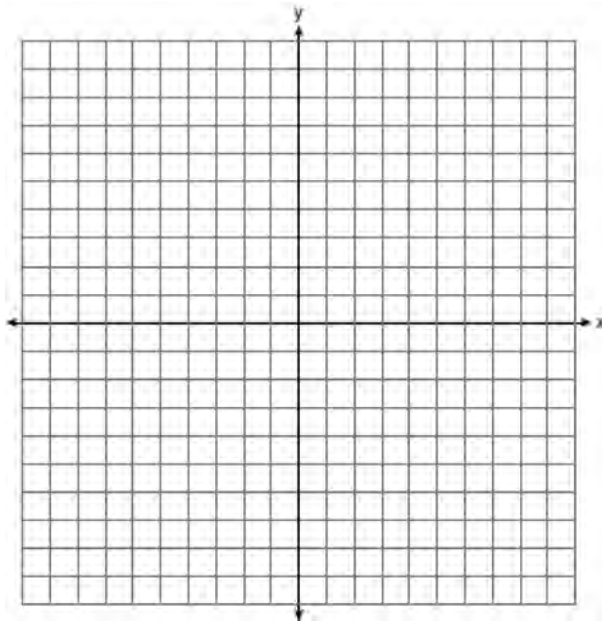

438 Find algebraically the equation of the axis of symmetry and the coordinates of the vertex of the parabola whose equation is $y = -2x^2 - 8x + 3$.

439 Solve algebraically for x : $\frac{x+2}{6} = \frac{3}{x-1}$

440 Perform the indicated operation and simplify:

$$\frac{3x+6}{4x+12} \div \frac{x^2-4}{x+3}$$

441 A line having a slope of $\frac{3}{4}$ passes through the point (-8,4). Write the equation of this line in slope-intercept form.

442 Given the following list of students' scores on a quiz:

5, 12, 7, 15, 20, 14, 7

Determine the median of these scores. Determine the mode of these scores. The teacher decides to adjust these scores by adding three points to each score. Explain the effect, if any, that this will have on the median and mode of these scores.

443 Hannah took a trip to visit her cousin. She drove 120 miles to reach her cousin's house and the same distance back home. It took her 1.2 hours to get halfway to her cousin's house. What was her average speed, in miles per hour, for the first 1.2 hours of the trip? Hannah's average speed for the remainder of the trip to her cousin's house was 40 miles per hour. How long, in hours, did it take her to drive the remaining distance? Traveling home along the same route, Hannah drove at an average rate of 55 miles per hour. After 2 hours her car broke down. How many miles was she from home?

444 Find the roots of the equation $x^2 - x = 6$ algebraically.

Integrated Algebra 3 Point Regents Exam Questions

www.jmap.org

- 445 Given: $A = \{18, 6, -3, -12\}$
 Determine all elements of set A that are in the solution of the inequality $\frac{2}{3}x + 3 < -2x - 7$.

- 446 Graph and label the following equations on the set of axes below.

$$y = |x|$$

$$y = \left| \frac{1}{2}x \right|$$

Explain how *decreasing* the coefficient of x affects the graph of the equation $y = |x|$.

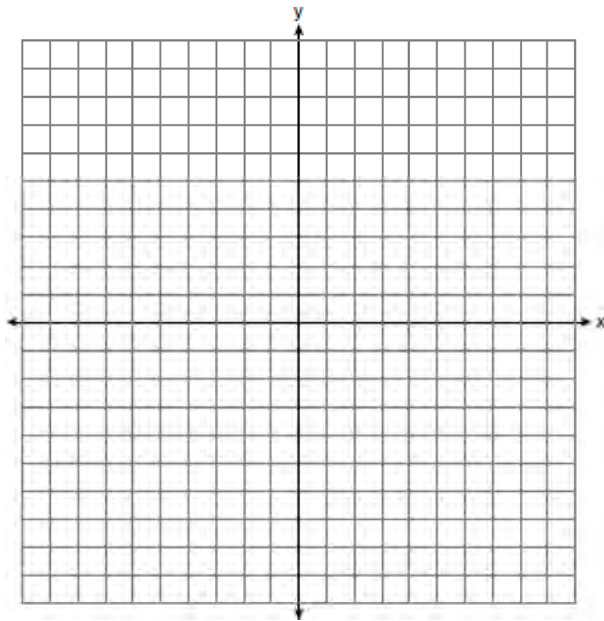

- 448 Graph the equation $y = x^2 - 2x - 3$ on the accompanying set of axes. Using the graph, determine the roots of the equation $x^2 - 2x - 3 = 0$.

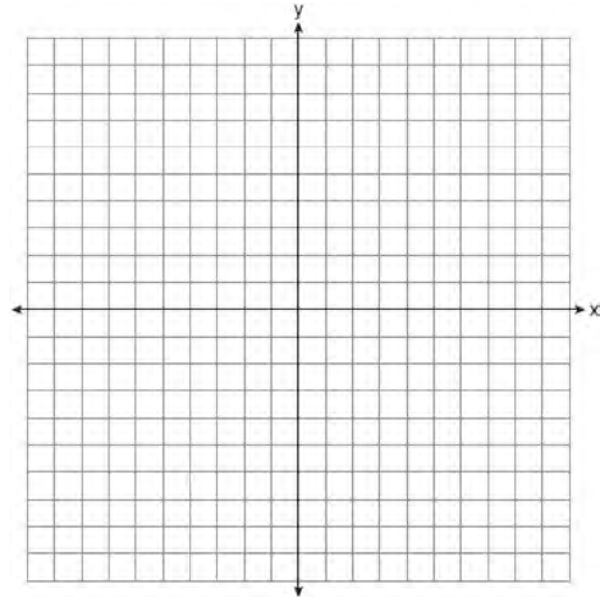

- 449 The chart below compares two runners.

Runner	Distance, in miles	Time, in hours
Greg	11	2
Dave	16	3

Based on the information in this chart, state which runner has the faster rate. Justify your answer.

- 447 Express $\frac{16\sqrt{21}}{2\sqrt{7}} - 5\sqrt{12}$ in simplest radical form.

- 450 On the set of axes below, graph and label the equations $y = |x|$ and $y = 3|x|$ for the interval $-3 \leq x \leq 3$.

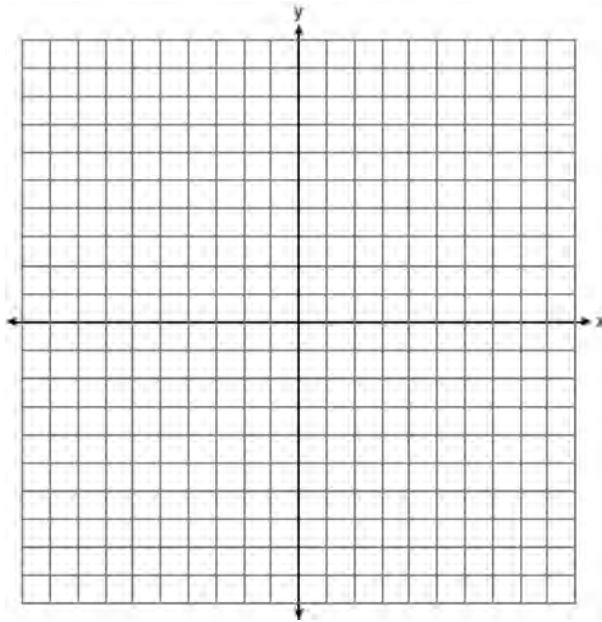

Explain how changing the coefficient of the absolute value from 1 to 3 affects the graph.

- 451 The number of songs fifteen students have on their MP3 players is:
 120, 124, 132, 145, 200, 255, 260, 292,
 308, 314, 342, 407, 421, 435, 452
 State the values of the minimum, 1st quartile, median, 3rd quartile, and maximum. Using these values, construct a box-and-whisker plot using an appropriate scale on the line below.

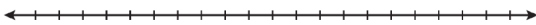

- 452 The table below shows the number of prom tickets sold over a ten-day period.

Prom Ticket Sales

Day (x)	1	2	5	7	10
Number of Prom Tickets Sold (y)	30	35	55	60	70

Plot these data points on the coordinate grid below. Use a consistent and appropriate scale. Draw a reasonable line of best fit and write its equation.

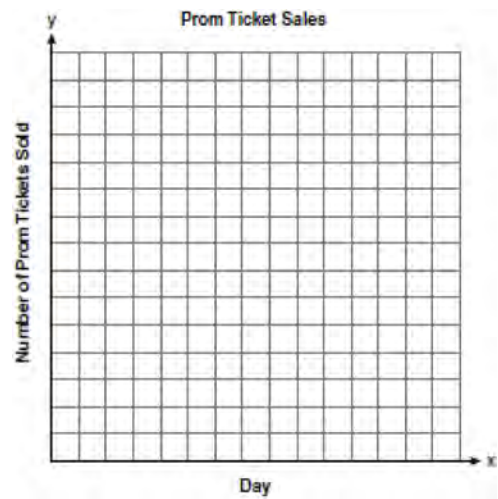

- 453 Sarah measures her rectangular bedroom window for a new shade. Her measurements are 36 inches by 42 inches. The actual measurements of the window are 36.5 inches and 42.5 inches. Using the measurements that Sarah took, determine the number of square inches in the area of the window. Determine the number of square inches in the actual area of the window. Determine the relative error in calculating the area. Express your answer as a decimal to the *nearest thousandth*.

- 454 In the diagram below, the circumference of circle O is 16π inches. The length of \overline{BC} is three-quarters of the length of diameter \overline{AD} and $CE = 4$ inches. Calculate the area, in square inches, of trapezoid $ABCD$.

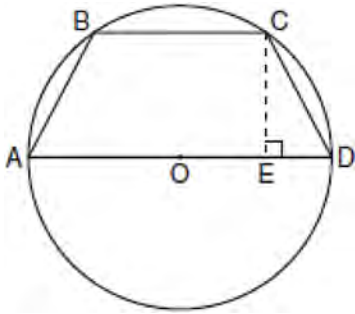

458 Solve algebraically for x : $2(x - 4) \geq \frac{1}{2}(5 - 3x)$

- 459 Find the volume, in cubic centimeters, *and* the surface area, in square centimeters, of the rectangular prism shown below.

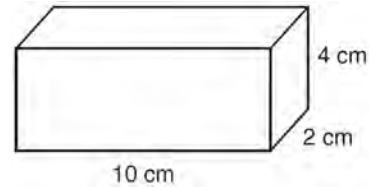

- 455 Chelsea has \$45 to spend at the fair. She spends \$20 on admission and \$15 on snacks. She wants to play a game that costs \$0.65 per game. Write an inequality to find the maximum number of times, x , Chelsea can play the game. Using this inequality, determine the maximum number of times she can play the game.

- 460 Megan and Bryce opened a new store called the Donut Pit. Their goal is to reach a profit of \$20,000 in their 18th month of business. The table and scatter plot below represent the profit, P , in thousands of dollars, that they made during the first 12 months.

- 456 A plastic storage box in the shape of a rectangular prism has a length of $x + 3$, a width of $x - 4$, and a height of 5. Represent the surface area of the box as a trinomial in terms of x .

t (months)	P (profit, in thousands of dollars)
1	3.0
2	2.5
3	4.0
4	5.0
5	6.5
6	5.5
7	7.0
8	6.0
9	7.5
10	7.0
11	9.0
12	9.5

- 457 A soup can is in the shape of a cylinder. The can has a volume of 342 cm^3 and a diameter of 6 cm. Express the height of the can in terms of π . Determine the maximum number of soup cans that can be stacked on their base between two shelves if the distance between the shelves is exactly 36 cm. Explain your answer.

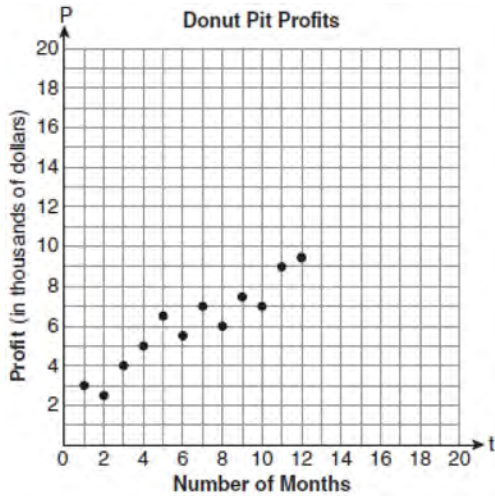

Draw a reasonable line of best fit. Using the line of best fit, predict whether Megan and Bryce will reach their goal in the 18th month of their business. Justify your answer.

461 A trapezoid is shown below.

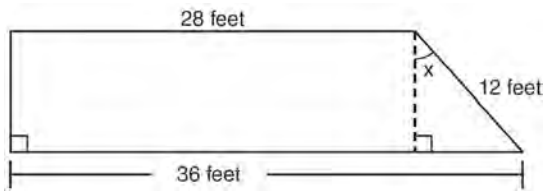

Calculate the measure of angle x , to the *nearest tenth of a degree*.

462 Using his ruler, Howell measured the sides of a rectangular prism to be 5 cm by 8 cm by 4 cm. The actual measurements are 5.3 cm by 8.2 cm by 4.1 cm. Find Howell's relative error in calculating the volume of the prism, to the *nearest thousandth*.

463 The test scores for 18 students in Ms. Mosher's class are listed below:

- 86, 81, 79, 71, 58, 87, 52, 71, 87,
 87, 93, 64, 94, 81, 76, 98, 94, 68

Complete the frequency table below.

Interval	Tally	Frequency
51–60		
61–70		
71–80		
81–90		
91–100		

Draw and label a frequency histogram on the grid below.

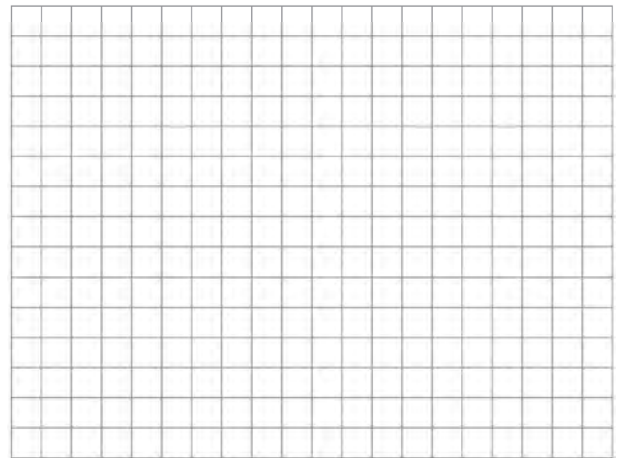

464 A turtle and a rabbit are in a race to see who is first to reach a point 100 feet away. The turtle travels at a constant speed of 20 feet per minute for the entire 100 feet. The rabbit travels at a constant speed of 40 feet per minute for the first 50 feet, stops for 3 minutes, and then continues at a constant speed of 40 feet per minute for the last 50 feet. Determine which animal won the race and by how much time.

Integrated Algebra 3 Point Regents Exam Questions

www.jmap.org

- 465 A bank is advertising that new customers can open a savings account with a $3\frac{3}{4}\%$ interest rate compounded annually. Robert invests \$5,000 in an account at this rate. If he makes no additional deposits or withdrawals on his account, find the amount of money he will have, to the *nearest cent*, after three years.
- 466 Peter begins his kindergarten year able to spell 10 words. He is going to learn to spell 2 new words every day. Write an inequality that can be used to determine how many days, d , it takes Peter to be able to spell *at least* 75 words. Use this inequality to determine the minimum number of whole days it will take for him to be able to spell *at least* 75 words.
- 467 Express the product of $3\sqrt{20}(2\sqrt{5} - 7)$ in simplest radical form.
- 468 The Hudson Record Store is having a going-out-of-business sale. CDs normally sell for \$18.00. During the first week of the sale, all CDs will sell for \$15.00. Written as a fraction, what is the rate of discount? What is this rate expressed as a percent? Round your answer to the *nearest hundredth of a percent*. During the second week of the sale, the same CDs will be on sale for 25% off the *original* price. What is the price of a CD during the second week of the sale?

Integrated Algebra 4 Point Regents Exam Questions

- 469 A restaurant sells kids' meals consisting of one main course, one side dish, and one drink, as shown in the table below.

Main Course	Side Dish	Drink
hamburger	French fries	milk
chicken nuggets	applesauce	juice
turkey sandwich		soda

Draw a tree diagram or list the sample space showing all possible kids' meals. How many different kids' meals can a person order? Jose does not drink juice. Determine the number of different kids' meals that do *not* include juice. Jose's sister will eat *only* chicken nuggets for her main course. Determine the number of different kids' meals that include chicken nuggets.

- 470 Twenty students were surveyed about the number of days they played outside in one week. The results of this survey are shown below.

{6,5,4,3,0,7,1,5,4,4,3,2,2,3,2,4,3,4,0,7}

Complete the frequency table below for these data.

Interval	Tally	Frequency
0-1		
2-3		
4-5		
6-7		

Complete the cumulative frequency table below using these data.

Number of Days Outside

Interval	Cumulative Frequency
0-1	
0-3	
0-5	
0-7	

On the grid below, create a cumulative frequency histogram based on the table you made.

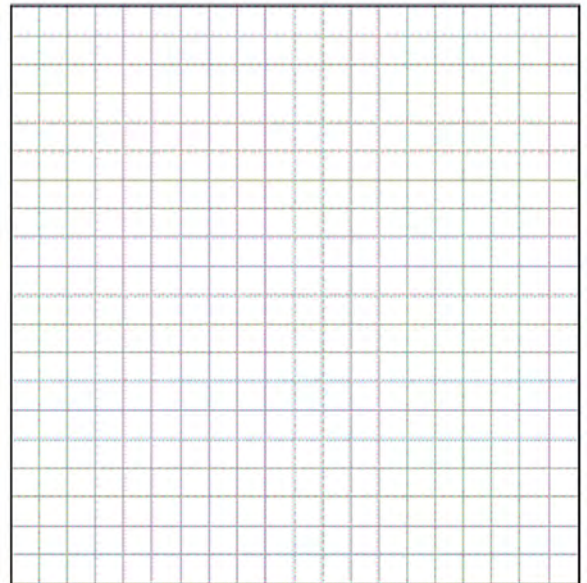

- 471 Express in simplest form: $\frac{2x^2 - 8x - 42}{6x^2} \div \frac{x^2 - 9}{x^2 - 3x}$

- 472 On the set of axes below, solve the following system of equations graphically and state the coordinates of all points in the solution set.

$$y = x^2 + 4x - 5$$

$$y = x - 1$$

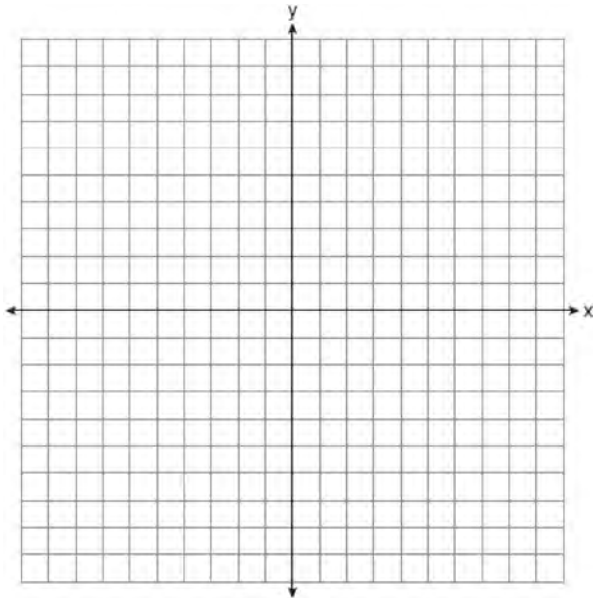

- 473 Shana wants to buy a new bicycle that has a retail price of \$259.99. She knows that it will be on sale next week for 30% off the retail price. If the tax rate is 7%, find the total amount, to the *nearest cent*, that she will save by waiting until next week.

- 474 The Booster Club raised \$30,000 for a sports fund. No more money will be placed into the fund. Each year the fund will decrease by 5%. Determine the amount of money, to the *nearest cent*, that will be left in the sports fund after 4 years.

- 475 The values of 11 houses on Washington St. are shown in the table below.

Value per House	Number of Houses
\$100,000	1
\$175,000	5
\$200,000	4
\$700,000	1

Find the mean value of these houses in dollars.
 Find the median value of these houses in dollars.
 State which measure of central tendency, the mean or the median, *best* represents the values of these 11 houses. Justify your answer.

- 476 On the set of axes below, graph the following system of inequalities and state the coordinates of a point in the solution set.

$$2x - y \geq 6$$

$$x > 2$$

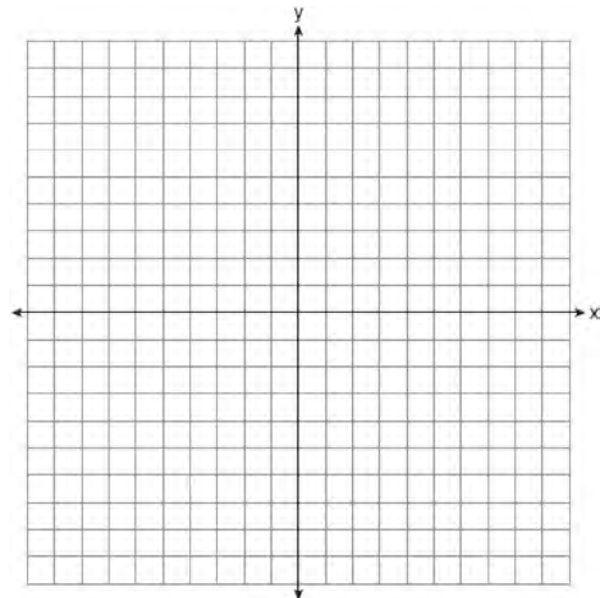

Integrated Algebra 4 Point Regents Exam Questions

www.jmap.org

- 477 On the set of axes below, solve the following system of equations graphically and state the coordinates of *all* points in the solution set.

$$y = -x^2 + 6x - 3$$

$$x + y = 7$$

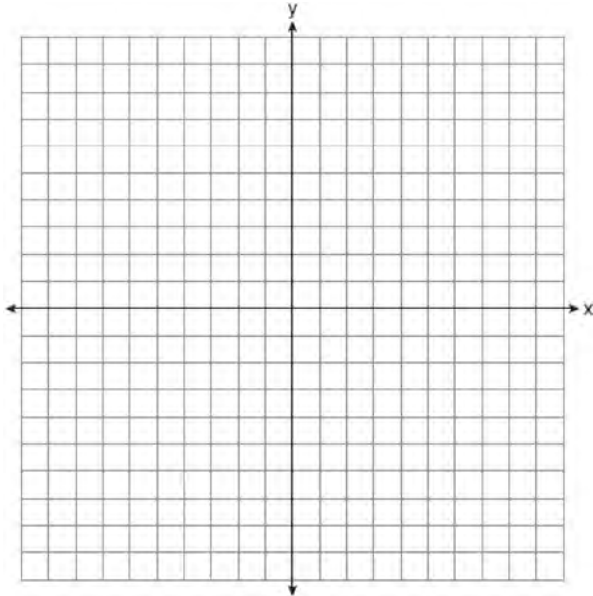

- 478 A password consists of three digits, 0 through 9, followed by three letters from an alphabet having 26 letters. If repetition of digits is allowed, but repetition of letters is not allowed, determine the number of different passwords that can be made. If repetition is not allowed for digits or letters, determine how many fewer different passwords can be made.

- 479 Express in simplest form:

$$\frac{x^2 + 9x + 14}{x^2 - 49} \div \frac{3x + 6}{x^2 + x - 56}$$

- 480 A stake is to be driven into the ground away from the base of a 50-foot pole, as shown in the diagram below. A wire from the stake on the ground to the top of the pole is to be installed at an angle of elevation of 52° .

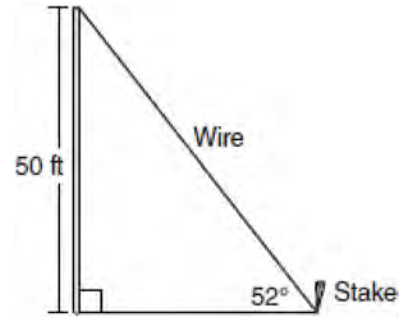

How far away from the base of the pole should the stake be driven in, to the *nearest foot*? What will be the length of the wire from the stake to the top of the pole, to the *nearest foot*?

- 481 Graph the solution set for the inequality $4x - 3y > 9$ on the set of axes below. Determine if the point $(1, -3)$ is in the solution set. Justify your answer.

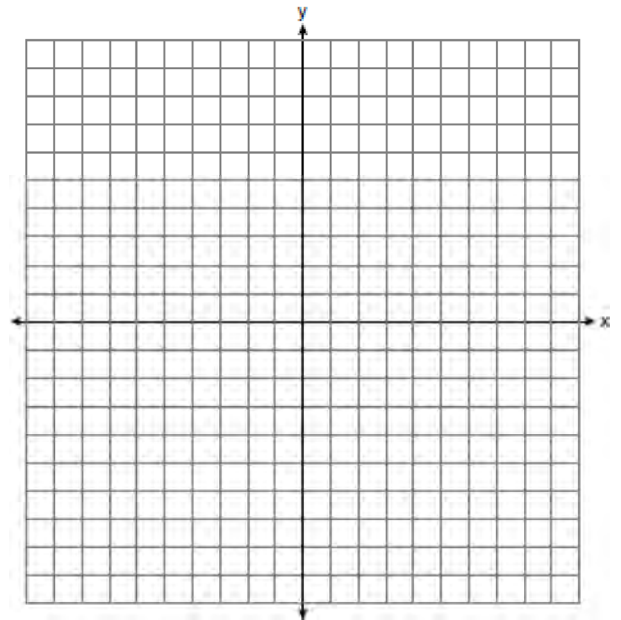

- 482 Solve the following system of inequalities graphically on the set of axes below.

$$3x + y < 7$$

$$y \geq \frac{2}{3}x - 4$$

State the coordinates of a point in the solution set.

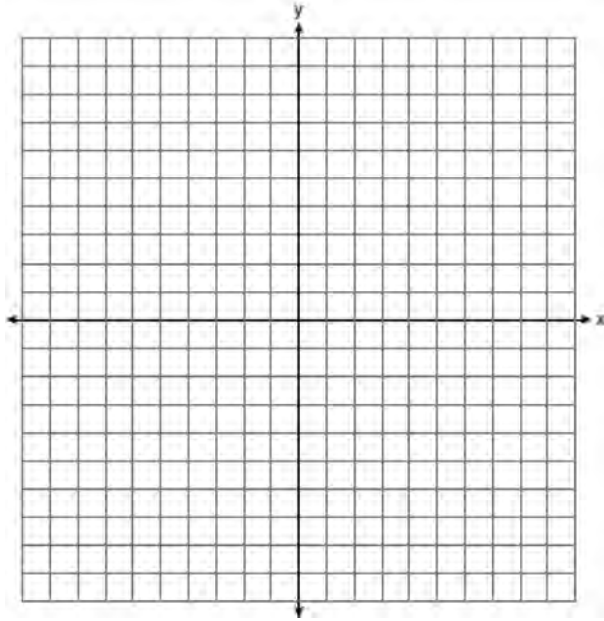

- 483 The test scores from Mrs. Gray's math class are shown below.
 72, 73, 66, 71, 82, 85, 95, 85, 86, 89, 91, 92
 Construct a box-and-whisker plot to display these data.

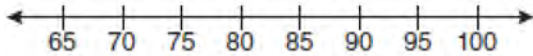

- 484 The sum of three consecutive odd integers is 18 less than five times the middle number. Find the three integers. [Only an algebraic solution can receive full credit.]

- 485 The diagram below shows a cumulative frequency histogram of the students' test scores in Ms. Wedow's algebra class.

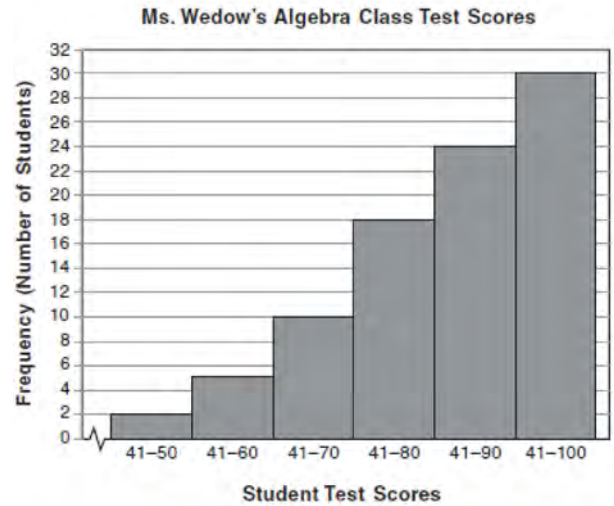

Determine the total number of students in the class. Determine how many students scored higher than 70. State which *ten-point interval* contains the median. State which *two ten-point intervals* contain the same frequency.

- 486 An outfit Jennifer wears to school consists of a top, a bottom, and shoes. Possible choices are listed below.

Tops: T-shirt, blouse, sweater

Bottoms: jeans, skirt, capris

Shoes: flip-flops, sneakers

List the sample space or draw a tree diagram to represent all possible outfits consisting of one type of top, one type of bottom, and one pair of shoes. Determine how many different outfits contain jeans and flip-flops. Determine how many different outfits do *not* include a sweater.

- 487 The prices of seven race cars sold last week are listed in the table below.

Price per Race Car	Number of Race Cars
\$126,000	1
\$140,000	2
\$180,000	1
\$400,000	2
\$819,000	1

What is the mean value of these race cars, in dollars? What is the median value of these race cars, in dollars? State which of these measures of central tendency best represents the value of the seven race cars. Justify your answer.

- 488 On the set of axes below, solve the following system of inequalities graphically.

$$y < 2x + 1$$

$$y \geq -\frac{1}{3}x + 4$$

State the coordinates of a point in the solution set.

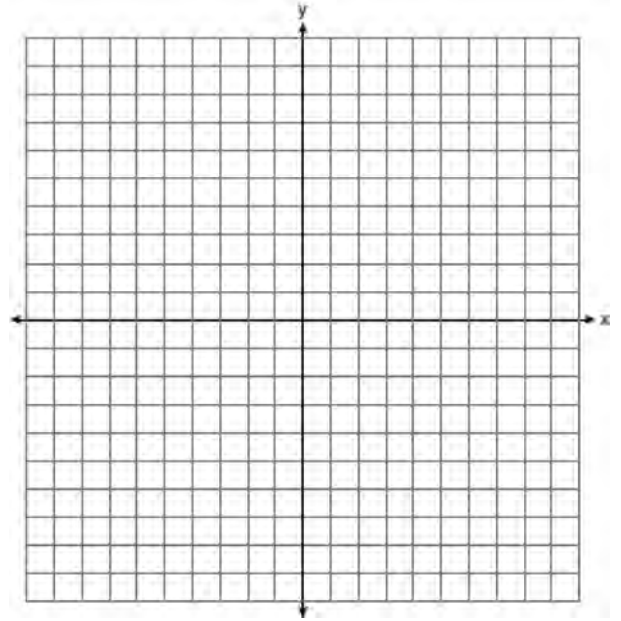

- 489 Solve the following systems of equations graphically, on the set of axes below, and state the coordinates of the point(s) in the solution set.

$$y = x^2 - 6x + 5$$

$$2x + y = 5$$

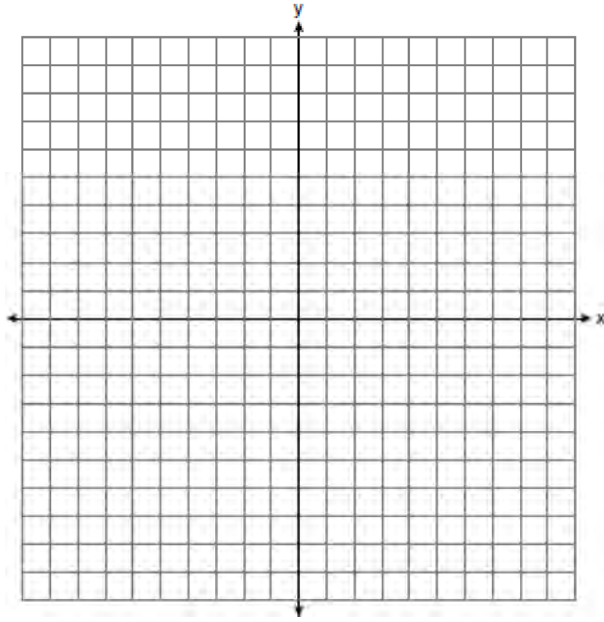

- 492 Graph the following systems of inequalities on the set of axes shown below and label the solution set S :

$$y > -x + 2$$

$$y \leq \frac{2}{3}x + 5$$

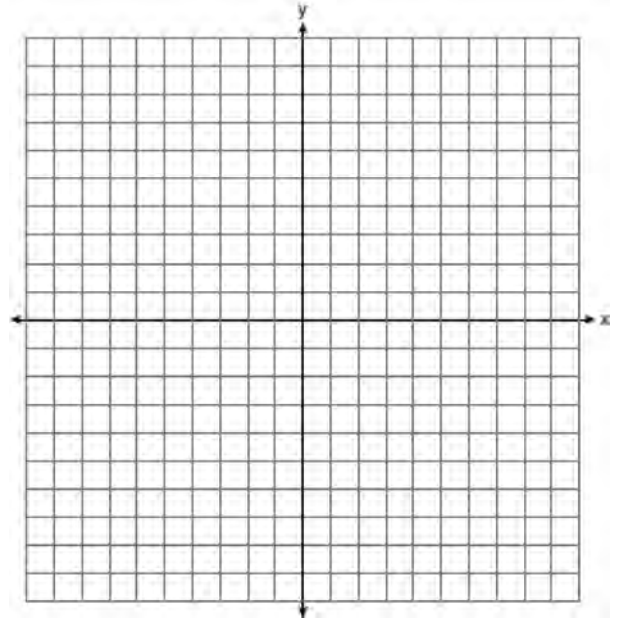

- 490 Vince buys a box of candy that consists of six chocolate pieces, four fruit-flavored pieces, and two mint pieces. He selects three pieces of candy at random, without replacement. Calculate the probability that the first piece selected will be fruit flavored and the other two will be mint. Calculate the probability that all three pieces selected will be the same type of candy.

- 493 Solve algebraically for x : $\frac{3}{4} = \frac{-(x+11)}{4x} + \frac{1}{2x}$

- 491 Solve the following system of equations algebraically:

$$3x + 2y = 4$$

$$4x + 3y = 7$$

[Only an algebraic solution can receive full credit.]

- 494 On the set of axes below, solve the following system of equations graphically for all values of x and y .

$$y = -x^2 - 4x + 12$$

$$y = -2x + 4$$

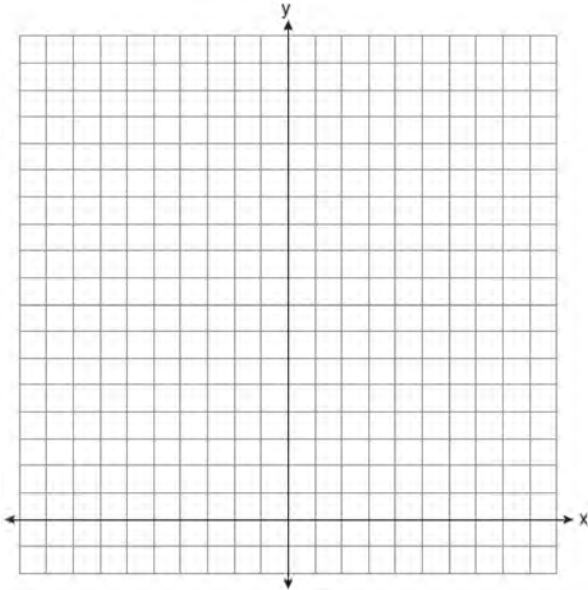

- 495 An oil company distributes oil in a metal can shaped like a cylinder that has an actual radius of 5.1 cm and a height of 15.1 cm. A worker incorrectly measured the radius as 5 cm and the height as 15 cm. Determine the relative error in calculating the surface area, to the *nearest thousandth*.

- 496 A contractor needs 54 square feet of brick to construct a rectangular walkway. The length of the walkway is 15 feet more than the width. Write an equation that could be used to determine the dimensions of the walkway. Solve this equation to find the length and width, in feet, of the walkway.

- 497 Solve for m : $\frac{m}{5} + \frac{3(m-1)}{2} = 2(m-3)$

- 498 On the set of axes below, solve the following system of equations graphically for all values of x and y .

$$y = x^2 - 6x + 1$$

$$y + 2x = 6$$

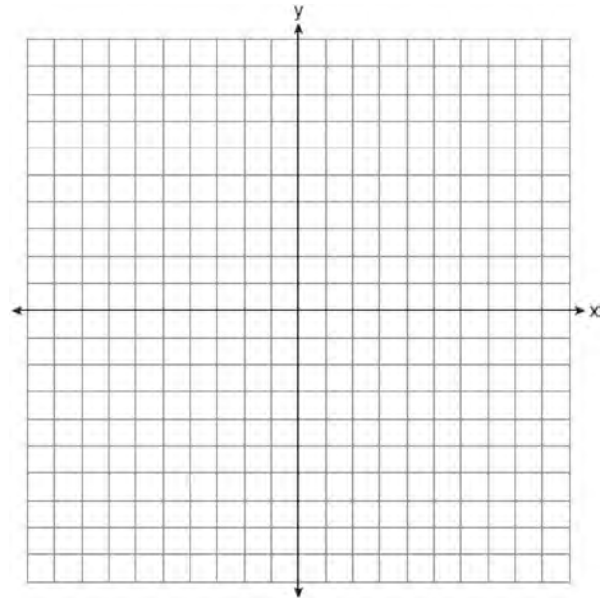

- 499 Sophie measured a piece of paper to be 21.7 cm by 28.5 cm. The piece of paper is actually 21.6 cm by 28.4 cm. Determine the number of square centimeters in the area of the piece of paper using Sophie's measurements. Determine the number of square centimeters in the actual area of the piece of paper. Determine the relative error in calculating the area. Express your answer as a decimal to the *nearest thousandth*. Sophie does not think there is a significant amount of error. Do you agree or disagree? Justify your answer.

500 Solve for x : $\frac{x+1}{x} = \frac{-7}{x-12}$

501 Each of the hats shown below has colored marbles placed inside. Hat A contains five green marbles and four red marbles. Hat B contains six blue marbles and five red marbles. Hat C contains five green marbles and five blue marbles.



If a student were to randomly pick one marble from each of these three hats, determine from which hat the student would most likely pick a green marble. Justify your answer. Determine the fewest number of marbles, if any, and the color of these marbles that could be added to *each* hat so that the probability of picking a green marble will be one-half in each of the three hats.

502 The Fahrenheit temperature readings on 30 April mornings in Stormville, New York, are shown below.

- 41°, 58°, 61°, 54°, 49°, 46°, 52°, 58°, 67°, 43°,
 47°, 60°, 52°, 58°, 48°, 44°, 59°, 66°, 62°, 55°,
 44°, 49°, 62°, 61°, 59°, 54°, 57°, 58°, 63°, 60°

Using the data, complete the frequency table below.

Interval	Tally	Frequency
40–44		
45–49		
50–54		
55–59		
60–64		
65–69		

On the grid below, construct and label a frequency histogram based on the table.

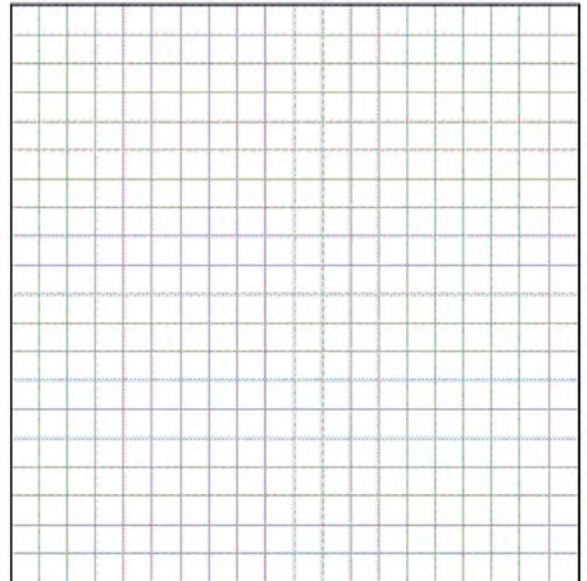

Integrated Algebra 4 Point Regents Exam Questions
www.jmap.org

503 The cost of 3 markers and 2 pencils is \$1.80. The cost of 4 markers and 6 pencils is \$2.90. What is the cost of *each* item? Include appropriate units in your answer.

504 Find three consecutive positive even integers such that the product of the second and third integers is twenty more than ten times the first integer. [Only an algebraic solution can receive full credit.]

505 On the grid below, solve the system of equations graphically for x and y .

$$4x - 2y = 10$$

$$y = -2x - 1$$

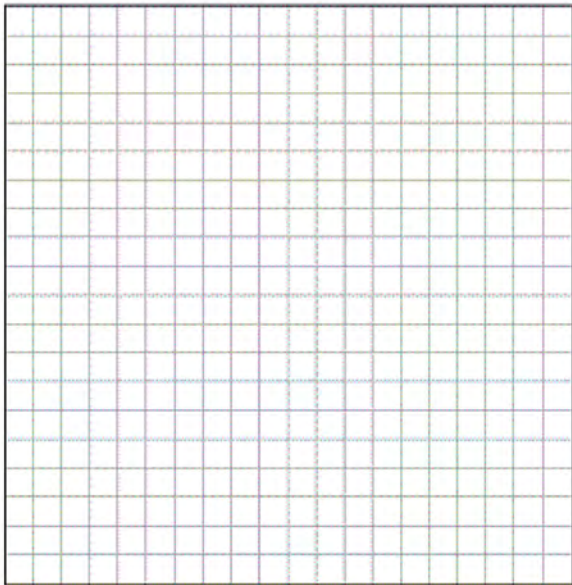

506 A sandwich consists of one type of bread, one type of meat, and one type of cheese. The possible choices are listed below.

Bread: white, rye

Meat: ham, turkey, beef

Cheese: American, Swiss

Draw a tree diagram or list a sample space of all the possible different sandwiches consisting of one type of bread, one type of meat, and one type of cheese. Determine the number of sandwiches that will *not* include turkey. Determine the number of sandwiches that will include rye bread and Swiss cheese.

507 A hot-air balloon is tied to the ground with two taut (straight) ropes, as shown in the diagram below.

One rope is directly under the balloon and makes a right angle with the ground. The other rope forms an angle of 50° with the ground.

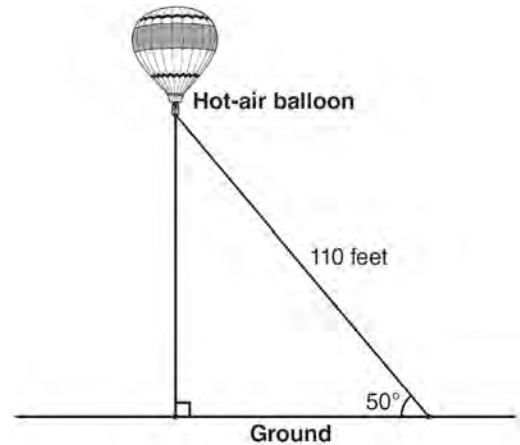

Determine the height, to the *nearest foot*, of the balloon directly above the ground. Determine the distance, to the *nearest foot*, on the ground between the two ropes.