

# JMAP REGENTS BY DATE

The NY Geometry Regents Exams  
Fall, 2008-August, 2013

[www.jmap.org](http://www.jmap.org)

**fall08ge**

- 1 Isosceles trapezoid  $ABCD$  has diagonals  $\overline{AC}$  and  $\overline{BD}$ . If  $AC = 5x + 13$  and  $BD = 11x - 5$ , what is the value of  $x$ ?
  - 1) 28
  - 2)  $10\frac{3}{4}$
  - 3) 3
  - 4)  $\frac{1}{2}$
  
- 2 What is the negation of the statement “The Sun is shining”?
  - 1) It is cloudy.
  - 2) It is daytime.
  - 3) It is not raining.
  - 4) The Sun is not shining.
  
- 3 Triangle  $ABC$  has vertices  $A(1,3)$ ,  $B(0,1)$ , and  $C(4,0)$ . Under a translation,  $A'$ , the image point of  $A$ , is located at  $(4,4)$ . Under this same translation, point  $C'$  is located at
  - 1)  $(7,1)$
  - 2)  $(5,3)$
  - 3)  $(3,2)$
  - 4)  $(1,-1)$

- 4 The diagram below shows the construction of the perpendicular bisector of  $\overline{AB}$ .

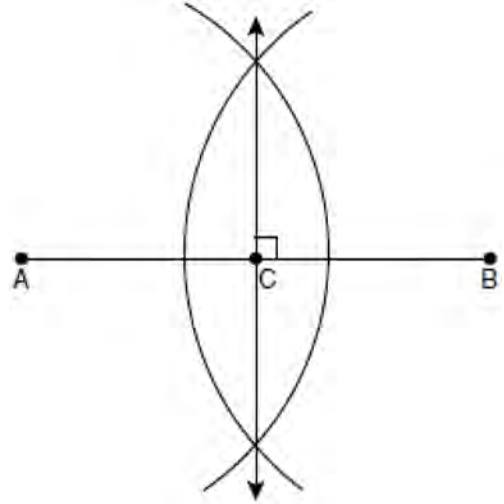

Which statement is *not* true?

- 1)  $AC = CB$
- 2)  $CB = \frac{1}{2}AB$
- 3)  $AC = 2AB$
- 4)  $AC + CB = AB$

- 5 Which graph could be used to find the solution to the following system of equations?

$$y = -x + 2$$

$$y = x^2$$

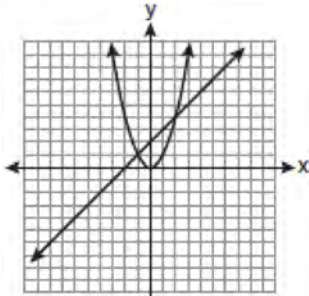

1)

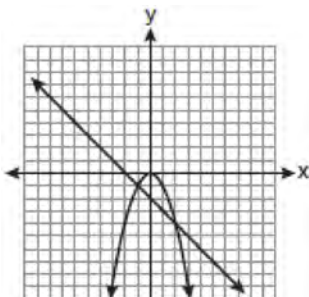

2)

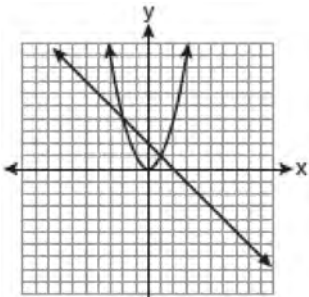

3)

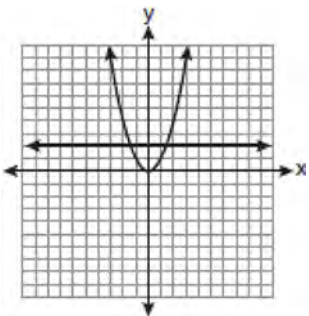

4)

- 6 Line  $k$  is drawn so that it is perpendicular to two distinct planes,  $P$  and  $R$ . What must be true about planes  $P$  and  $R$ ?

- 1) Planes  $P$  and  $R$  are skew.
- 2) Planes  $P$  and  $R$  are parallel.
- 3) Planes  $P$  and  $R$  are perpendicular.
- 4) Plane  $P$  intersects plane  $R$  but is not perpendicular to plane  $R$ .

- 7 The diagram below illustrates the construction of  $\overleftrightarrow{PS}$  parallel to  $\overleftrightarrow{RQ}$  through point  $P$ .

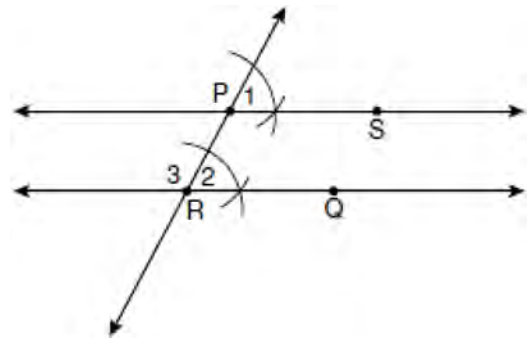

Which statement justifies this construction?

- 1)  $m\angle 1 = m\angle 2$
- 2)  $m\angle 1 = m\angle 3$
- 3)  $\overline{PR} \cong \overline{RQ}$
- 4)  $\overline{PS} \cong \overline{RQ}$

- 8 The figure in the diagram below is a triangular prism.

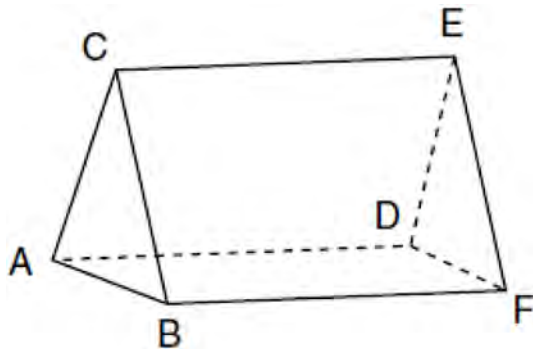

Which statement must be true?

- 1)  $\overline{DE} \cong \overline{AB}$
- 2)  $\overline{AD} \cong \overline{BC}$
- 3)  $\overline{AD} \parallel \overline{CE}$
- 4)  $\overline{DE} \parallel \overline{BC}$

- 9 The vertices of  $\triangle ABC$  are  $A(-1,-2)$ ,  $B(-1,2)$  and  $C(6,0)$ . Which conclusion can be made about the angles of  $\triangle ABC$ ?
- 1)  $m\angle A = m\angle B$
  - 2)  $m\angle A = m\angle C$
  - 3)  $m\angle ACB = 90$
  - 4)  $m\angle ABC = 60$

- 10 Given  $\triangle ABC$  with base  $\overline{AFEDC}$ , median  $\overline{BF}$ , altitude  $\overline{BD}$ , and  $\overline{BE}$  bisects  $\angle ABC$ , which conclusion is valid?

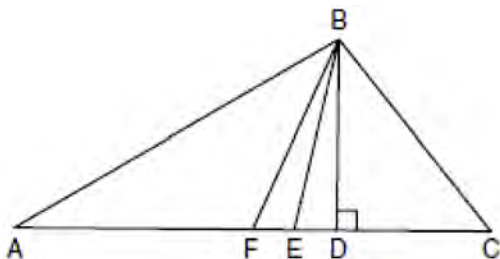

- 1)  $\angle FAB \cong \angle ABF$
- 2)  $\angle ABF \cong \angle CBD$
- 3)  $\overline{CE} \cong \overline{EA}$
- 4)  $\overline{CF} \cong \overline{FA}$

- 11 In the diagram below, circle  $O$  has a radius of 5, and  $\overline{CE} = 2$ . Diameter  $\overline{AC}$  is perpendicular to chord  $\overline{BD}$  at  $E$ .

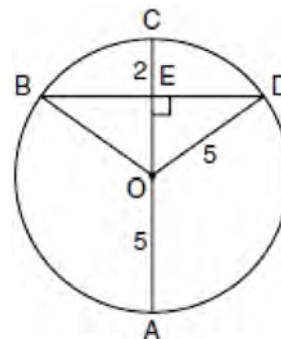

What is the length of  $\overline{BD}$ ?

- 1) 12
  - 2) 10
  - 3) 8
  - 4) 4
- 12 What is the equation of a line that passes through the point  $(-3,-11)$  and is parallel to the line whose equation is  $2x - y = 4$ ?
- 1)  $y = 2x + 5$
  - 2)  $y = 2x - 5$
  - 3)  $y = \frac{1}{2}x + \frac{25}{2}$
  - 4)  $y = -\frac{1}{2}x - \frac{25}{2}$
- 13 Line segment  $\overline{AB}$  has endpoints  $A(2,-3)$  and  $B(-4,6)$ . What are the coordinates of the midpoint of  $\overline{AB}$ ?
- 1)  $(-2,3)$
  - 2)  $(-1, 1\frac{1}{2})$
  - 3)  $(-1,3)$
  - 4)  $(3, 4\frac{1}{2})$

- 14 What are the center and radius of a circle whose equation is  $(x - A)^2 + (y - B)^2 = C$ ?
- 1) center =  $(A, B)$ ; radius =  $C$
  - 2) center =  $(-A, -B)$ ; radius =  $C$
  - 3) center =  $(A, B)$ ; radius =  $\sqrt{C}$
  - 4) center =  $(-A, -B)$ ; radius =  $\sqrt{C}$

- 15 A rectangular prism has a volume of  $3x^2 + 18x + 24$ . Its base has a length of  $x + 2$  and a width of 3. Which expression represents the height of the prism?
- 1)  $x + 4$
  - 2)  $x + 2$
  - 3) 3
  - 4)  $x^2 + 6x + 8$

- 16 Lines  $k_1$  and  $k_2$  intersect at point  $E$ . Line  $m$  is perpendicular to lines  $k_1$  and  $k_2$  at point  $E$ .

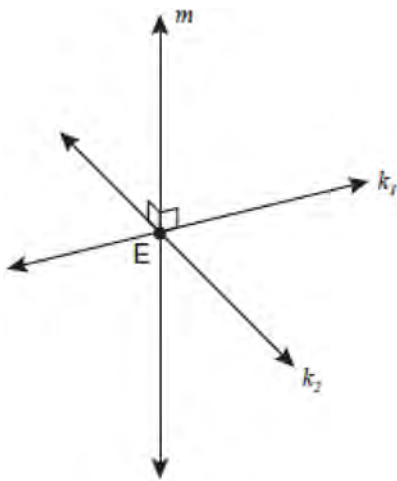

Which statement is always true?

- 1) Lines  $k_1$  and  $k_2$  are perpendicular.
- 2) Line  $m$  is parallel to the plane determined by lines  $k_1$  and  $k_2$ .
- 3) Line  $m$  is perpendicular to the plane determined by lines  $k_1$  and  $k_2$ .
- 4) Line  $m$  is coplanar with lines  $k_1$  and  $k_2$ .

- 17 In the diagram below,  $\overline{PS}$  is a tangent to circle  $O$  at point  $S$ ,  $\overline{PQR}$  is a secant,  $PS = x$ ,  $PQ = 3$ , and  $PR = x + 18$ .

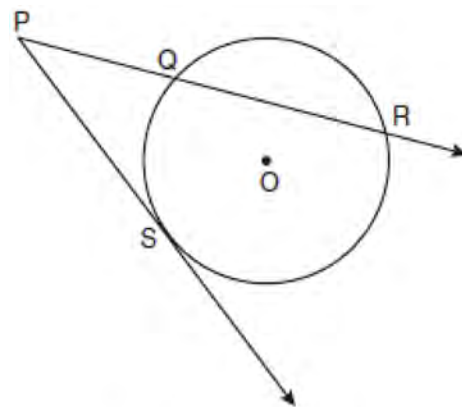

(Not drawn to scale)

What is the length of  $\overline{PS}$ ?

- 1) 6
  - 2) 9
  - 3) 3
  - 4) 27
- 18 A polygon is transformed according to the rule:  $(x, y) \rightarrow (x + 2, y)$ . Every point of the polygon moves two units in which direction?
- 1) up
  - 2) down
  - 3) left
  - 4) right

- 19 In the diagram below of  $\triangle ABC$ ,  $D$  is a point on  $\overline{AB}$ ,  $AC = 7$ ,  $AD = 6$ , and  $BC = 18$ .

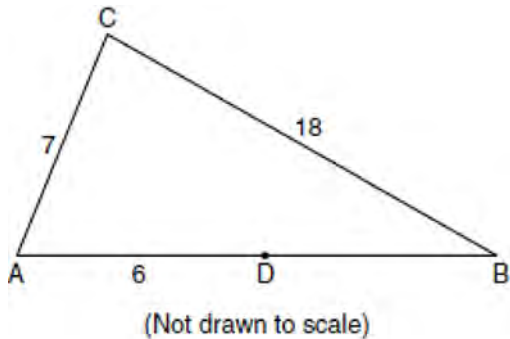

The length of  $\overline{DB}$  could be

- 1) 5
  - 2) 12
  - 3) 19
  - 4) 25
- 20 The diameter of a circle has endpoints at  $(-2,3)$  and  $(6,3)$ . What is an equation of the circle?
- 1)  $(x-2)^2 + (y-3)^2 = 16$
  - 2)  $(x-2)^2 + (y-3)^2 = 4$
  - 3)  $(x+2)^2 + (y+3)^2 = 16$
  - 4)  $(x+2)^2 + (y+3)^2 = 4$

- 21 In the diagram below of  $\triangle PRT$ ,  $Q$  is a point on  $\overline{PR}$ ,  $S$  is a point on  $\overline{TR}$ ,  $\overline{QS}$  is drawn, and  $\angle RPT \cong \angle RSQ$ .

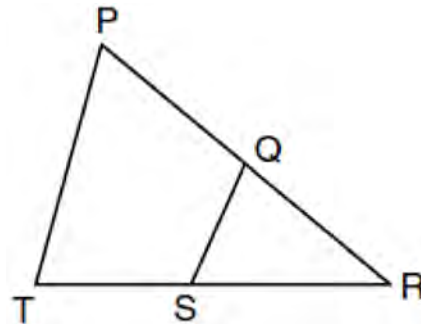

Which reason justifies the conclusion that  $\triangle PRT \sim \triangle SRQ$ ?

- 1) AA
  - 2) ASA
  - 3) SAS
  - 4) SSS
- 22 The lines  $3y + 1 = 6x + 4$  and  $2y + 1 = x - 9$  are
- 1) parallel
  - 2) perpendicular
  - 3) the same line
  - 4) neither parallel nor perpendicular
- 23 The endpoints of  $\overline{AB}$  are  $A(3,2)$  and  $B(7,1)$ . If  $\overline{A''B''}$  is the result of the transformation of  $\overline{AB}$  under  $D_2 \circ T_{-4,3}$  what are the coordinates of  $A''$  and  $B''$ ?
- 1)  $A''(-2,10)$  and  $B''(6,8)$
  - 2)  $A''(-1,5)$  and  $B''(3,4)$
  - 3)  $A''(2,7)$  and  $B''(10,5)$
  - 4)  $A''(14,-2)$  and  $B''(22,-4)$

- 24 In the diagram below, circle  $A$  and circle  $B$  are shown.

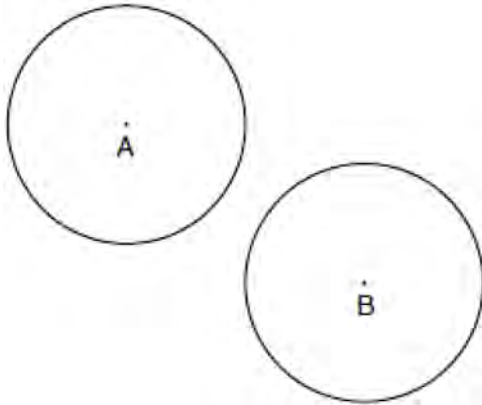

What is the total number of lines of tangency that are common to circle  $A$  and circle  $B$ ?

- 1) 1
  - 2) 2
  - 3) 3
  - 4) 4
- 25 In which triangle do the three altitudes intersect outside the triangle?
- 1) a right triangle
  - 2) an acute triangle
  - 3) an obtuse triangle
  - 4) an equilateral triangle
- 26 Two triangles are similar, and the ratio of each pair of corresponding sides is 2:1. Which statement regarding the two triangles is *not* true?
- 1) Their areas have a ratio of 4:1.
  - 2) Their altitudes have a ratio of 2:1.
  - 3) Their perimeters have a ratio of 2:1.
  - 4) Their corresponding angles have a ratio of 2:1.
- 27 What is the measure of an interior angle of a regular octagon?
- 1)  $45^\circ$
  - 2)  $60^\circ$
  - 3)  $120^\circ$
  - 4)  $135^\circ$

- 28 What is the slope of a line perpendicular to the line whose equation is  $5x + 3y = 8$ ?

- 1)  $\frac{5}{3}$
- 2)  $\frac{3}{5}$
- 3)  $-\frac{3}{5}$
- 4)  $-\frac{5}{3}$

- 29 In the diagram below of right triangle  $ACB$ , altitude  $\overline{CD}$  intersects  $\overline{AB}$  at  $D$ . If  $AD = 3$  and  $DB = 4$ , find the length of  $CD$  in simplest radical form.

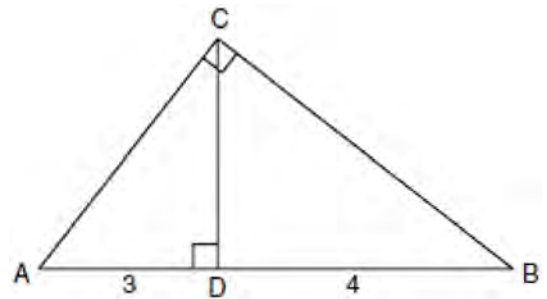

- 30 The vertices of  $\triangle ABC$  are  $A(3,2)$ ,  $B(6,1)$ , and  $C(4,6)$ . Identify and graph a transformation of  $\triangle ABC$  such that its image,  $\triangle A'B'C'$ , results in  $\overline{AB} \parallel \overline{A'B'}$ .

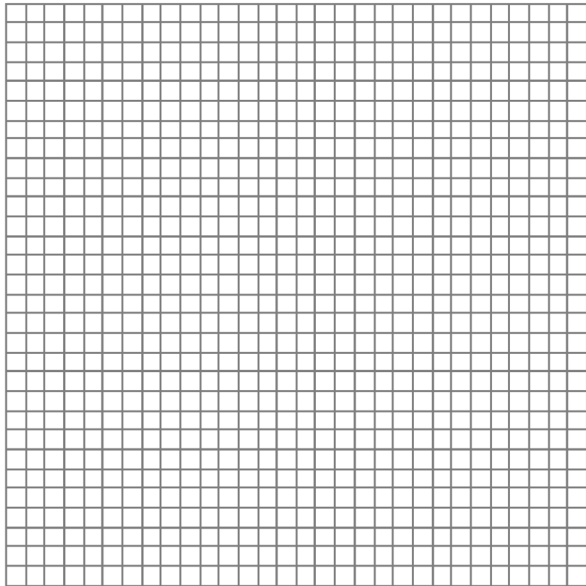

- 31 The endpoints of  $\overline{PQ}$  are  $P(-3,1)$  and  $Q(4,25)$ . Find the length of  $\overline{PQ}$ .

- 32 Using a compass and straightedge, construct the bisector of the angle shown below. [Leave all construction marks.]

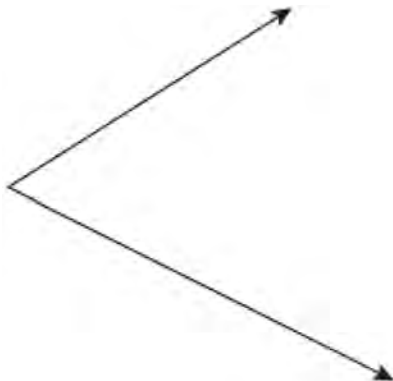

- 33 The volume of a cylinder is  $12,566.4 \text{ cm}^3$ . The height of the cylinder is 8 cm. Find the radius of the cylinder to the nearest tenth of a centimeter.
- 34 Write a statement that is logically equivalent to the statement “If two sides of a triangle are congruent, the angles opposite those sides are congruent.” Identify the new statement as the converse, inverse, or contrapositive of the original statement.
- 35 On the set of axes below, graph and label  $\triangle DEF$  with vertices at  $D(-4,-4)$ ,  $E(-2,2)$ , and  $F(8,-2)$ . If  $G$  is the midpoint of  $\overline{EF}$  and  $H$  is the midpoint of  $\overline{DF}$ , state the coordinates of  $G$  and  $H$  and label each point on your graph. Explain why  $\overline{GH} \parallel \overline{DE}$ .

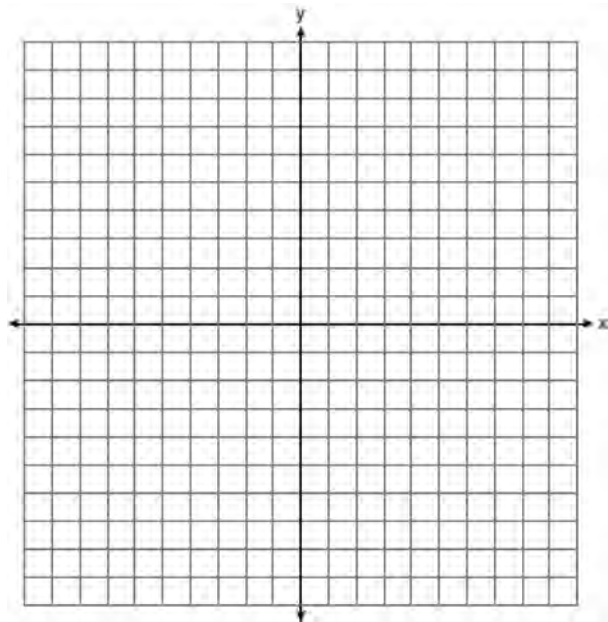



- 36 In the diagram below of circle  $O$ , chords  $\overline{DF}$ ,  $\overline{DE}$ ,  $\overline{FG}$ , and  $\overline{EG}$  are drawn such that  $m\widehat{DF} : m\widehat{FE} : m\widehat{EG} : m\widehat{GD} = 5 : 2 : 1 : 7$ . Identify one pair of inscribed angles that are congruent to each other and give their measure.

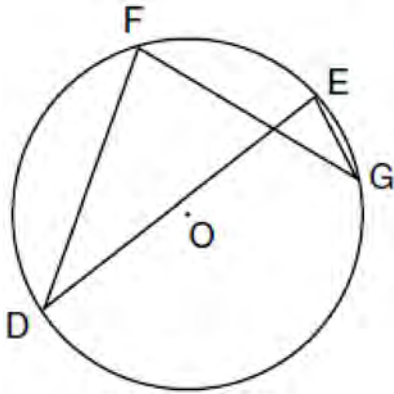

- 37 A city is planning to build a new park. The park must be equidistant from school  $A$  at  $(3,3)$  and school  $B$  at  $(3,-5)$ . The park also must be exactly 5 miles from the center of town, which is located at the origin on the coordinate graph. Each unit on the graph represents 1 mile. On the set of axes below, sketch the compound loci and label with an **X** all possible locations for the new park.

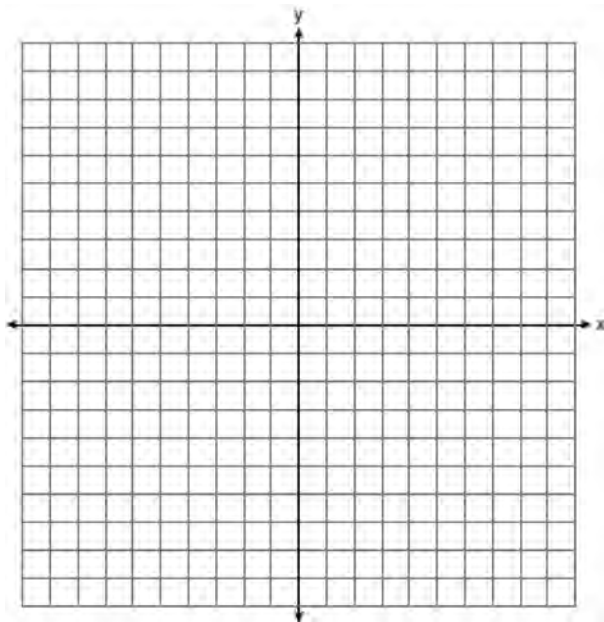

- 38 In the diagram below, quadrilateral  $ABCD$  is inscribed in circle  $O$ ,  $\overline{AB} \parallel \overline{DC}$ , and diagonals  $\overline{AC}$  and  $\overline{BD}$  are drawn. Prove that  $\triangle ACD \cong \triangle BDC$ .

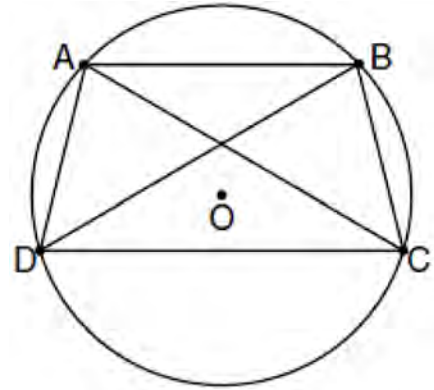

0609ge

- 1 Juliann plans on drawing  $\triangle ABC$ , where the measure of  $\angle A$  can range from  $50^\circ$  to  $60^\circ$  and the measure of  $\angle B$  can range from  $90^\circ$  to  $100^\circ$ . Given these conditions, what is the correct range of measures possible for  $\angle C$ ?
- 1)  $20^\circ$  to  $40^\circ$
  - 2)  $30^\circ$  to  $50^\circ$
  - 3)  $80^\circ$  to  $90^\circ$
  - 4)  $120^\circ$  to  $130^\circ$

- 2 In the diagram of  $\triangle ABC$  and  $\triangle DEF$  below,  $\overline{AB} \cong \overline{DE}$ ,  $\angle A \cong \angle D$ , and  $\angle B \cong \angle E$ .

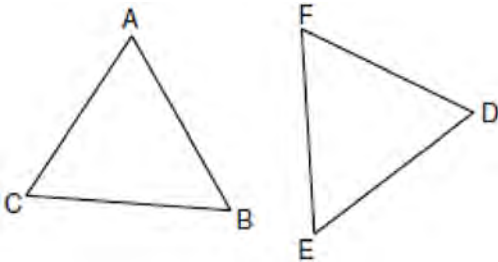

Which method can be used to prove  $\triangle ABC \cong \triangle DEF$ ?

- 1) SSS
- 2) SAS
- 3) ASA
- 4) HL

- 3 In the diagram below, under which transformation will  $\triangle A'B'C'$  be the image of  $\triangle ABC$ ?

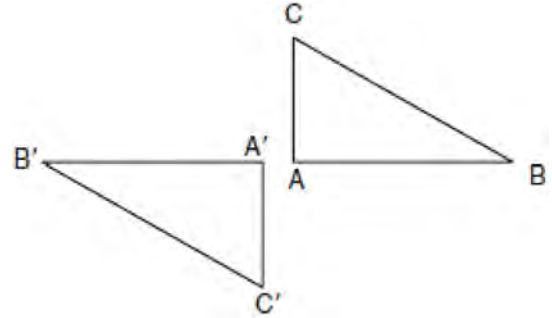

- 1) rotation
  - 2) dilation
  - 3) translation
  - 4) glide reflection
- 4 The lateral faces of a regular pyramid are composed of
- 1) squares
  - 2) rectangles
  - 3) congruent right triangles
  - 4) congruent isosceles triangles
- 5 Point A is located at  $(4, -7)$ . The point is reflected in the  $x$ -axis. Its image is located at
- 1)  $(-4, 7)$
  - 2)  $(-4, -7)$
  - 3)  $(4, 7)$
  - 4)  $(7, -4)$

- 6 In the diagram of circle  $O$  below, chords  $\overline{AB}$  and  $\overline{CD}$  are parallel, and  $\overline{BD}$  is a diameter of the circle.

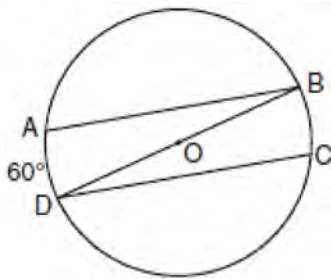

If  $m\widehat{AD} = 60$ , what is  $m\angle CDB$ ?

- 1) 20
  - 2) 30
  - 3) 60
  - 4) 120
- 7 What is an equation of the line that passes through the point  $(-2,5)$  and is perpendicular to the line whose equation is  $y = \frac{1}{2}x + 5$ ?
- 1)  $y = 2x + 1$
  - 2)  $y = -2x + 1$
  - 3)  $y = 2x + 9$
  - 4)  $y = -2x - 9$

- 8 After a composition of transformations, the coordinates  $A(4,2)$ ,  $B(4,6)$ , and  $C(2,6)$  become  $A''(-2,-1)$ ,  $B''(-2,-3)$ , and  $C''(-1,-3)$ , as shown on the set of axes below.

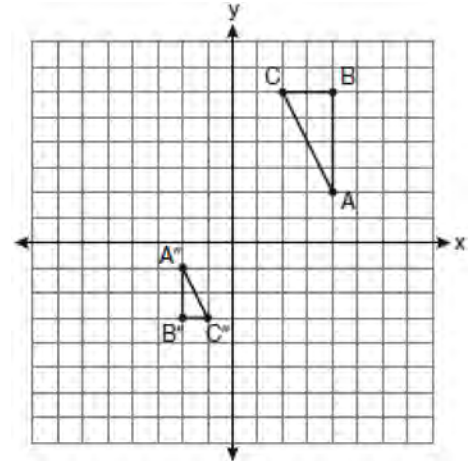

Which composition of transformations was used?

- 1)  $R_{180^\circ} \circ D_2$
  - 2)  $R_{90^\circ} \circ D_2$
  - 3)  $D_{\frac{1}{2}} \circ R_{180^\circ}$
  - 4)  $D_{\frac{1}{2}} \circ R_{90^\circ}$
- 9 In an equilateral triangle, what is the difference between the sum of the exterior angles and the sum of the interior angles?
- 1)  $180^\circ$
  - 2)  $120^\circ$
  - 3)  $90^\circ$
  - 4)  $60^\circ$
- 10 What is an equation of a circle with its center at  $(-3,5)$  and a radius of 4?
- 1)  $(x-3)^2 + (y+5)^2 = 16$
  - 2)  $(x+3)^2 + (y-5)^2 = 16$
  - 3)  $(x-3)^2 + (y+5)^2 = 4$
  - 4)  $(x+3)^2 + (y-5)^2 = 4$

- 11 In  $\triangle ABC$ ,  $m\angle A = 95$ ,  $m\angle B = 50$ , and  $m\angle C = 35$ . Which expression correctly relates the lengths of the sides of this triangle?
- 1)  $AB < BC < CA$
  - 2)  $AB < AC < BC$
  - 3)  $AC < BC < AB$
  - 4)  $BC < AC < AB$

- 12 In a coordinate plane, how many points are both 5 units from the origin and 2 units from the  $x$ -axis?
- 1) 1
  - 2) 2
  - 3) 3
  - 4) 4

- 13 What is the contrapositive of the statement, "If I am tall, then I will bump my head"?
- 1) If I bump my head, then I am tall.
  - 2) If I do not bump my head, then I am tall.
  - 3) If I am tall, then I will not bump my head.
  - 4) If I do not bump my head, then I am not tall.

- 14 In the diagram of  $\triangle ABC$  below, Jose found centroid  $P$  by constructing the three medians. He measured  $CF$  and found it to be 6 inches.

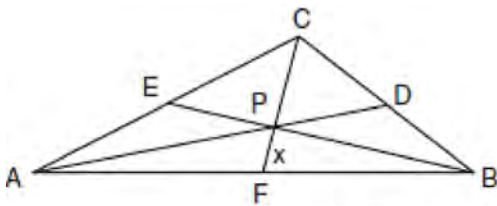

If  $PF = x$ , which equation can be used to find  $x$ ?

- 1)  $x + x = 6$
- 2)  $2x + x = 6$
- 3)  $3x + 2x = 6$
- 4)  $x + \frac{2}{3}x = 6$

- 15 In the diagram below, the length of the legs  $\overline{AC}$  and  $\overline{BC}$  of right triangle  $ABC$  are 6 cm and 8 cm, respectively. Altitude  $\overline{CD}$  is drawn to the hypotenuse of  $\triangle ABC$ .

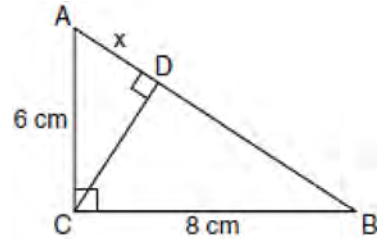

What is the length of  $\overline{AD}$  to the nearest tenth of a centimeter?

- 1) 3.6
- 2) 6.0
- 3) 6.4
- 4) 4.0

- 16 In the diagram below, tangent  $\overline{AB}$  and secant  $\overline{ACD}$  are drawn to circle  $O$  from an external point  $A$ ,  $AB = 8$ , and  $AC = 4$ .

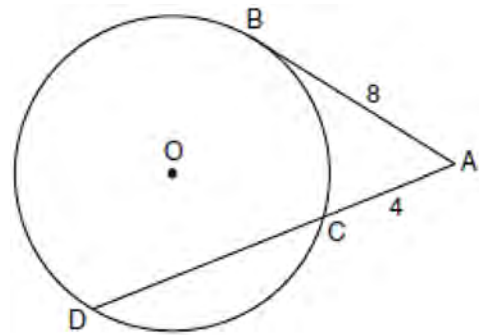

What is the length of  $\overline{CD}$ ?

- 1) 16
- 2) 13
- 3) 12
- 4) 10

- 17 In the diagram of  $\triangle ABC$  and  $\triangle EDC$  below,  $\overline{AE}$  and  $\overline{BD}$  intersect at  $C$ , and  $\angle CAB \cong \angle CED$ .

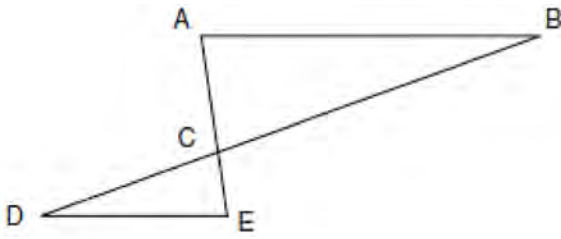

Which method can be used to show that  $\triangle ABC$  must be similar to  $\triangle EDC$ ?

- 1) SAS
  - 2) AA
  - 3) SSS
  - 4) HL
- 18 Point  $P$  is on line  $m$ . What is the total number of planes that are perpendicular to line  $m$  and pass through point  $P$ ?
- 1) 1
  - 2) 2
  - 3) 0
  - 4) infinite

- 19 Square  $LMNO$  is shown in the diagram below.

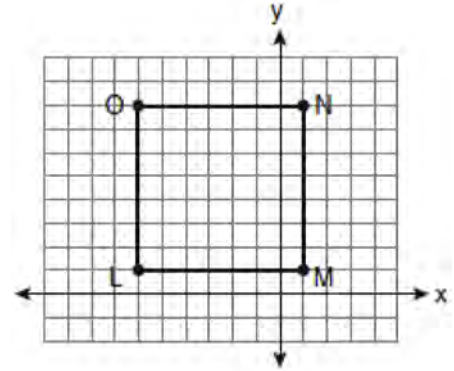

What are the coordinates of the midpoint of diagonal  $\overline{LN}$ ?

- 1)  $\left(4\frac{1}{2}, -2\frac{1}{2}\right)$
- 2)  $\left(-3\frac{1}{2}, 3\frac{1}{2}\right)$
- 3)  $\left(-2\frac{1}{2}, 3\frac{1}{2}\right)$
- 4)  $\left(-2\frac{1}{2}, 4\frac{1}{2}\right)$

- 20 Which graph represents a circle with the equation  $(x-5)^2 + (y+1)^2 = 9$ ?

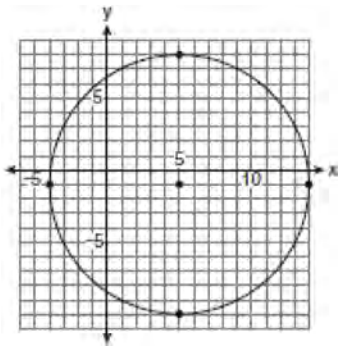
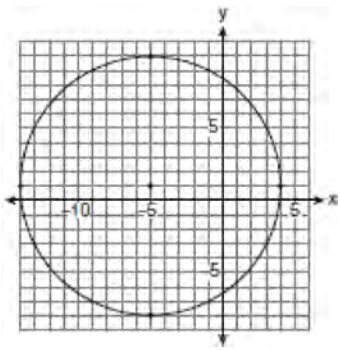
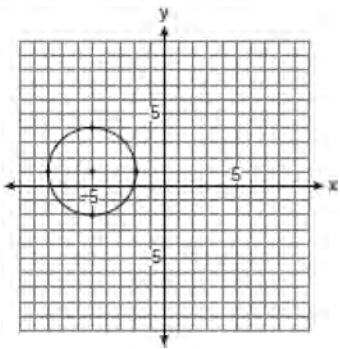
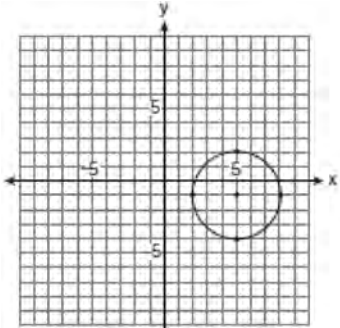

- 21 In the diagram below, a right circular cone has a diameter of 8 inches and a height of 12 inches.

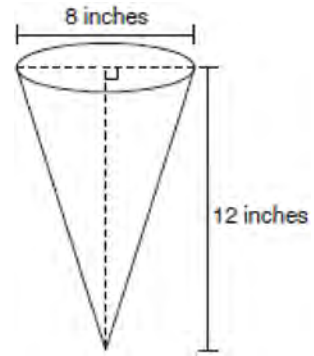

What is the volume of the cone to the *nearest cubic inch*?

- 1) 201  
 2) 481  
 3) 603  
 4) 804
- 22 A circle is represented by the equation  $x^2 + (y+3)^2 = 13$ . What are the coordinates of the center of the circle and the length of the radius?
- 1) (0,3) and 13  
 2) (0,3) and  $\sqrt{13}$   
 3) (0,-3) and 13  
 4) (0,-3) and  $\sqrt{13}$
- 23 Given the system of equations:  $y = x^2 - 4x$   
 $x = 4$

The number of points of intersection is

- 1) 1  
 2) 2  
 3) 3  
 4) 0

- 24 Side  $\overline{PQ}$  of  $\triangle PQR$  is extended through  $Q$  to point  $T$ . Which statement is *not* always true?
- 1)  $m\angle RQT > m\angle R$
  - 2)  $m\angle RQT > m\angle P$
  - 3)  $m\angle RQT = m\angle P + m\angle R$
  - 4)  $m\angle RQT > m\angle PQR$

- 25 Which illustration shows the correct construction of an angle bisector?

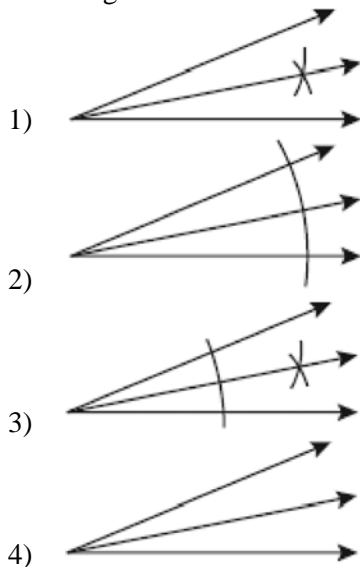

- 26 Which equation represents a line perpendicular to the line whose equation is  $2x + 3y = 12$ ?
- 1)  $6y = -4x + 12$
  - 2)  $2y = 3x + 6$
  - 3)  $2y = -3x + 6$
  - 4)  $3y = -2x + 12$

- 27 In  $\triangle ABC$ , point  $D$  is on  $\overline{AB}$ , and point  $E$  is on  $\overline{BC}$  such that  $\overline{DE} \parallel \overline{AC}$ . If  $DB = 2$ ,  $DA = 7$ , and  $DE = 3$ , what is the length of  $\overline{AC}$ ?
- 1) 8
  - 2) 9
  - 3) 10.5
  - 4) 13.5

- 28 In three-dimensional space, two planes are parallel and a third plane intersects both of the parallel planes. The intersection of the planes is a
- 1) plane
  - 2) point
  - 3) pair of parallel lines
  - 4) pair of intersecting lines

- 29 In the diagram of  $\triangle ABC$  below,  $AB = 10$ ,  $BC = 14$ , and  $AC = 16$ . Find the perimeter of the triangle formed by connecting the midpoints of the sides of  $\triangle ABC$ .

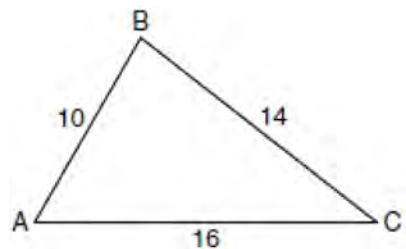

- 30 Using a compass and straightedge, construct a line that passes through point  $P$  and is perpendicular to line  $m$ . [Leave all construction marks.]



- 31 Find an equation of the line passing through the point  $(5, 4)$  and parallel to the line whose equation is  $2x + y = 3$ .

- 32 The length of  $\overline{AB}$  is 3 inches. On the diagram below, sketch the points that are equidistant from  $A$  and  $B$  and sketch the points that are 2 inches from  $A$ . Label with an **X** all points that satisfy both conditions.



- 33 Given: Two is an even integer or three is an even integer.  
Determine the truth value of this disjunction.  
Justify your answer.

- 34 In the diagram below,  $\triangle ABC \sim \triangle EFG$ ,  $m\angle C = 4x + 30$ , and  $m\angle G = 5x + 10$ . Determine the value of  $x$ .

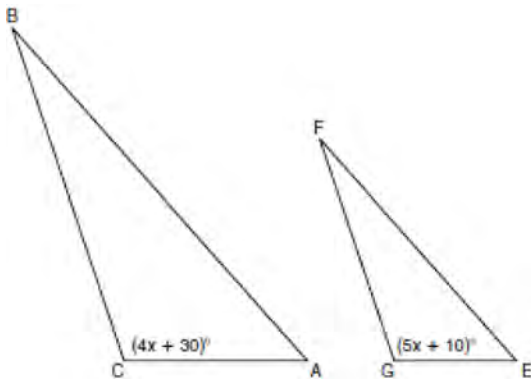

- 35 In the diagram below, circles  $X$  and  $Y$  have two tangents drawn to them from external point  $T$ . The points of tangency are  $C$ ,  $A$ ,  $S$ , and  $E$ . The ratio of  $\overline{TA}$  to  $\overline{AC}$  is  $1:3$ . If  $TS = 24$ , find the length of  $\overline{SE}$ .

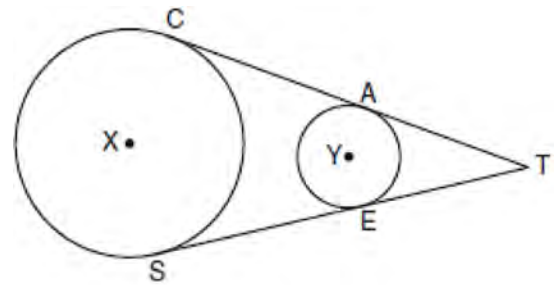

(Not drawn to scale)



- 36 Triangle  $ABC$  has coordinates  $A(-6,2)$ ,  $B(-3,6)$ , and  $C(5,0)$ . Find the perimeter of the triangle. Express your answer in simplest radical form. [The use of the grid below is optional.]

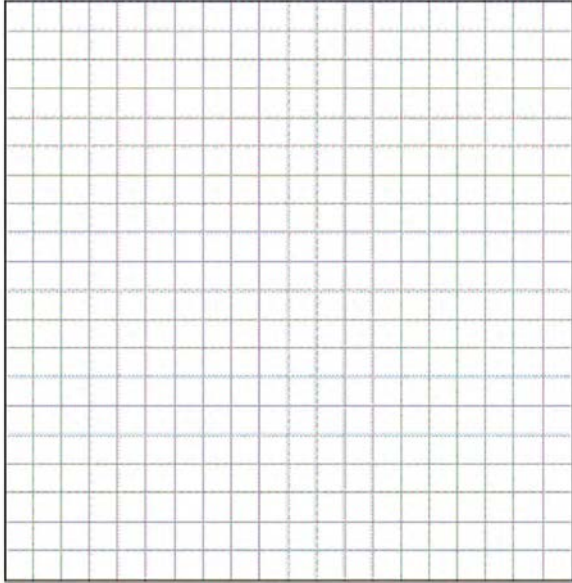

- 37 The coordinates of the vertices of parallelogram  $ABCD$  are  $A(-2,2)$ ,  $B(3,5)$ ,  $C(4,2)$ , and  $D(-1,-1)$ . State the coordinates of the vertices of parallelogram  $A''B''C''D''$  that result from the transformation  $r_{y\text{-axis}} \circ T_{2,-3}$ . [The use of the set of axes below is optional.]

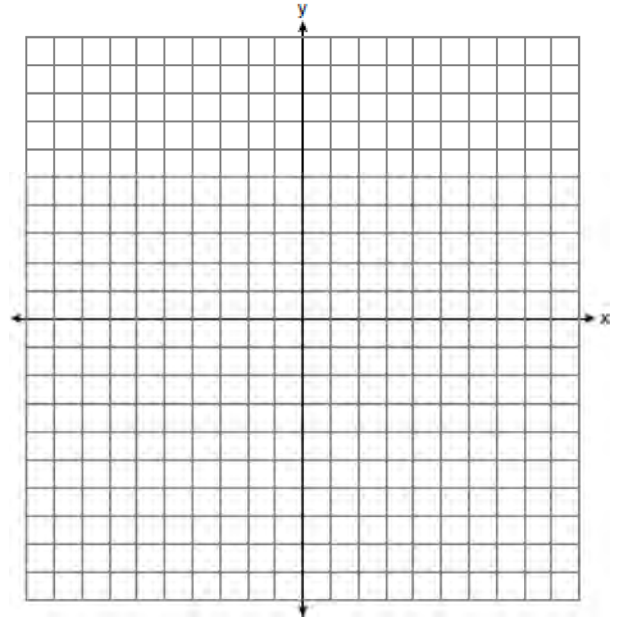

- 38 Given:  $\triangle ABC$  and  $\triangle EDC$ ,  $C$  is the midpoint of  $\overline{BD}$  and  $\overline{AE}$   
 Prove:  $\overline{AB} \parallel \overline{DE}$

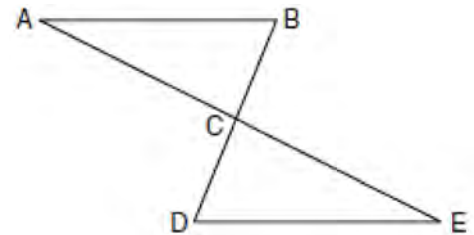

0809ge

- 1 Based on the diagram below, which statement is true?

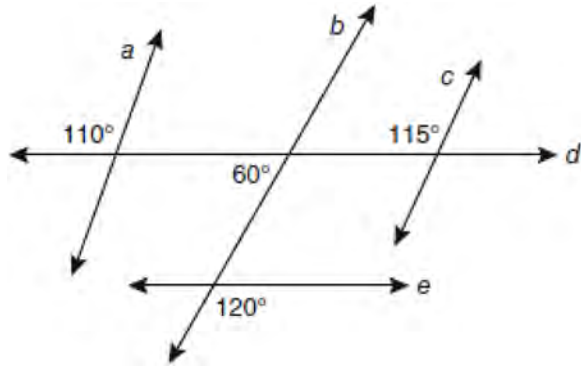

- 1)  $a \parallel b$
- 2)  $a \parallel c$
- 3)  $b \parallel c$
- 4)  $d \parallel e$

- 2 The diagram below shows the construction of the bisector of  $\angle ABC$ .

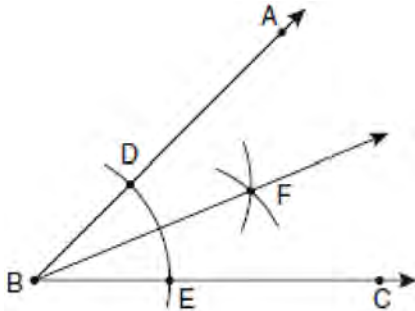

Which statement is *not* true?

- 1)  $m\angle EBF = \frac{1}{2} m\angle ABC$
- 2)  $m\angle DBF = \frac{1}{2} m\angle ABC$
- 3)  $m\angle EBF = m\angle ABC$
- 4)  $m\angle DBF = m\angle EBF$

- 3 In the diagram of  $\triangle ABC$  below,  $\overline{AB} \cong \overline{AC}$ . The measure of  $\angle B$  is  $40^\circ$ .

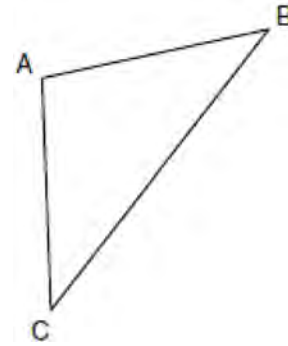

What is the measure of  $\angle A$ ?

- 1)  $40^\circ$
- 2)  $50^\circ$
- 3)  $70^\circ$
- 4)  $100^\circ$

- 4 In the diagram of circle  $O$  below, chord  $\overline{CD}$  is parallel to diameter  $\overline{AOB}$  and  $m\widehat{AC} = 30$ .

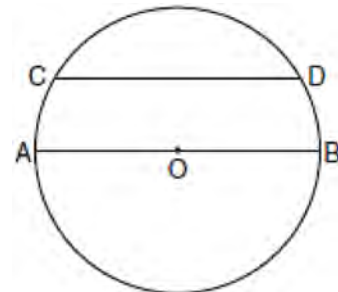

What is  $m\widehat{CD}$ ?

- 1) 150
- 2) 120
- 3) 100
- 4) 60

- 5 In the diagram of trapezoid  $ABCD$  below, diagonals  $\overline{AC}$  and  $\overline{BD}$  intersect at  $E$  and  $\triangle ABC \cong \triangle DCB$ .

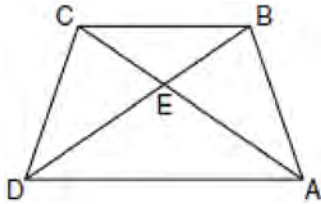

Which statement is true based on the given information?

- 1)  $\overline{AC} \cong \overline{BC}$
  - 2)  $\overline{CD} \cong \overline{AD}$
  - 3)  $\angle CDE \cong \angle BAD$
  - 4)  $\angle CDB \cong \angle BAC$
- 6 Which transformation produces a figure similar but not congruent to the original figure?
- 1)  $T_{1,3}$
  - 2)  $D_{\frac{1}{2}}$
  - 3)  $R_{90^\circ}$
  - 4)  $r_{y=x}$

- 7 In the diagram below of parallelogram  $ABCD$  with diagonals  $\overline{AC}$  and  $\overline{BD}$ ,  $m\angle 1 = 45$  and  $m\angle DCB = 120$ .

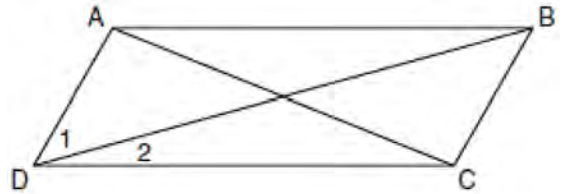

What is the measure of  $\angle 2$ ?

- 1)  $15^\circ$
  - 2)  $30^\circ$
  - 3)  $45^\circ$
  - 4)  $60^\circ$
- 8 On the set of axes below, Geoff drew rectangle  $ABCD$ . He will transform the rectangle by using the translation  $(x,y) \rightarrow (x+2,y+1)$  and then will reflect the translated rectangle over the  $x$ -axis.

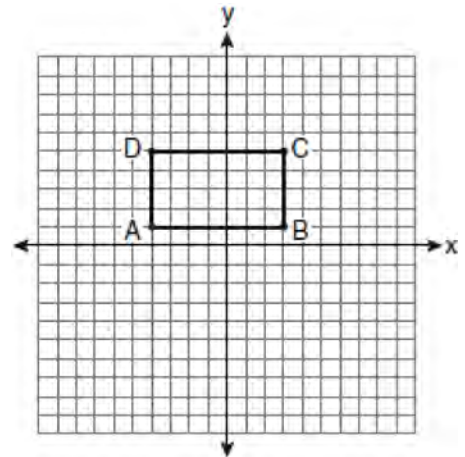

What will be the area of the rectangle after these transformations?

- 1) exactly 28 square units
- 2) less than 28 square units
- 3) greater than 28 square units
- 4) It cannot be determined from the information given.

9 What is the equation of a line that is parallel to the line whose equation is  $y = x + 2$ ?

- 1)  $x + y = 5$
- 2)  $2x + y = -2$
- 3)  $y - x = -1$
- 4)  $y - 2x = 3$

10 The endpoints of  $\overline{CD}$  are  $C(-2, -4)$  and  $D(6, 2)$ .  
What are the coordinates of the midpoint of  $\overline{CD}$ ?

- 1)  $(2, 3)$
- 2)  $(2, -1)$
- 3)  $(4, -2)$
- 4)  $(4, 3)$

11 What are the center and the radius of the circle whose equation is  $(x - 3)^2 + (y + 3)^2 = 36$ ?

- 1) center =  $(3, -3)$ ; radius = 6
- 2) center =  $(-3, 3)$ ; radius = 6
- 3) center =  $(3, -3)$ ; radius = 36
- 4) center =  $(-3, 3)$ ; radius = 36

12 Given the equations:  $y = x^2 - 6x + 10$

$$y + x = 4$$

What is the solution to the given system of equations?

- 1)  $(2, 3)$
- 2)  $(3, 2)$
- 3)  $(2, 2)$  and  $(1, 3)$
- 4)  $(2, 2)$  and  $(3, 1)$

13 The diagonal  $\overline{AC}$  is drawn in parallelogram  $ABCD$ .  
Which method can *not* be used to prove that  $\triangle ABC \cong \triangle CDA$ ?

- 1) SSS
- 2) SAS
- 3) SSA
- 4) ASA

14 In the diagram below, line  $k$  is perpendicular to plane  $\mathcal{P}$  at point  $T$ .

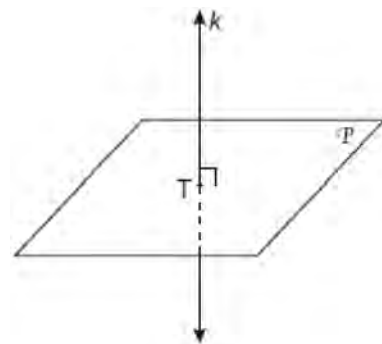

Which statement is true?

- 1) Any point in plane  $\mathcal{P}$  also will be on line  $k$ .
- 2) Only one line in plane  $\mathcal{P}$  will intersect line  $k$ .
- 3) All planes that intersect plane  $\mathcal{P}$  will pass through  $T$ .
- 4) Any plane containing line  $k$  is perpendicular to plane  $\mathcal{P}$ .

- 15 In the diagram below, which transformation was used to map  $\triangle ABC$  to  $\triangle A'B'C'$ ?

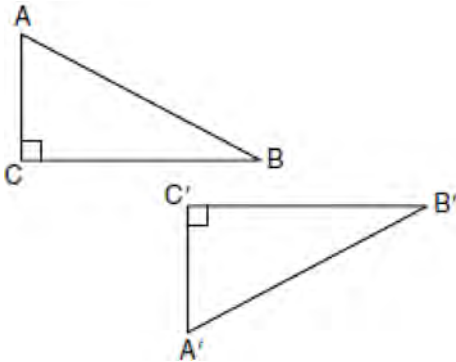

- 1) dilation  
 2) rotation  
 3) reflection  
 4) glide reflection
- 16 Which set of numbers represents the lengths of the sides of a triangle?
- 1) {5, 18, 13}  
 2) {6, 17, 22}  
 3) {16, 24, 7}  
 4) {26, 8, 15}
- 17 What is the slope of a line perpendicular to the line whose equation is  $y = -\frac{2}{3}x - 5$ ?

- 1)  $-\frac{3}{2}$   
 2)  $-\frac{2}{3}$   
 3)  $\frac{2}{3}$   
 4)  $\frac{3}{2}$

- 18 A quadrilateral whose diagonals bisect each other and are perpendicular is a
- 1) rhombus  
 2) rectangle  
 3) trapezoid  
 4) parallelogram

- 19 If the endpoints of  $\overline{AB}$  are  $A(-4, 5)$  and  $B(2, -5)$ , what is the length of  $\overline{AB}$ ?
- 1)  $2\sqrt{34}$   
 2) 2  
 3)  $\sqrt{61}$   
 4) 8

- 20 In the diagram below of  $\triangle ACT$ ,  $D$  is the midpoint of  $\overline{AC}$ ,  $O$  is the midpoint of  $\overline{AT}$ , and  $G$  is the midpoint of  $\overline{CT}$ .

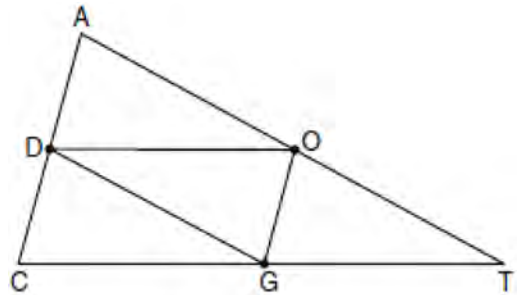

If  $AC = 10$ ,  $AT = 18$ , and  $CT = 22$ , what is the perimeter of parallelogram  $CDOG$ ?

- 1) 21  
 2) 25  
 3) 32  
 4) 40

- 21 Which equation represents circle  $K$  shown in the graph below?

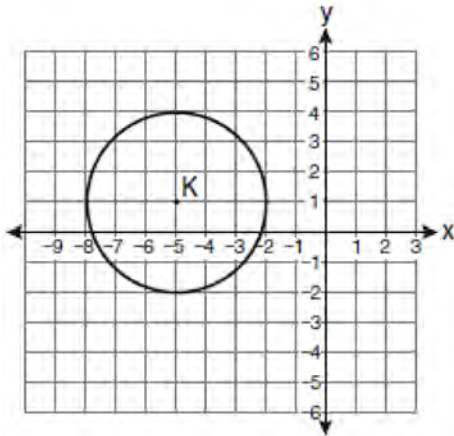

- 1)  $(x+5)^2 + (y-1)^2 = 3$
- 2)  $(x+5)^2 + (y-1)^2 = 9$
- 3)  $(x-5)^2 + (y+1)^2 = 3$
- 4)  $(x-5)^2 + (y+1)^2 = 9$

- 22 In the diagram below of right triangle  $ACB$ , altitude  $CD$  is drawn to hypotenuse  $AB$ .

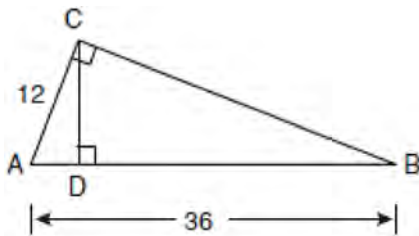

If  $AB = 36$  and  $AC = 12$ , what is the length of  $\overline{AD}$ ?

- 1) 32
- 2) 6
- 3) 3
- 4) 4

- 23 In the diagram of circle  $O$  below, chord  $\overline{AB}$  intersects chord  $\overline{CD}$  at  $E$ ,  $DE = 2x + 8$ ,  $EC = 3$ ,  $AE = 4x - 3$ , and  $EB = 4$ .

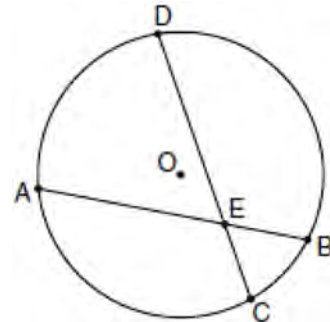

What is the value of  $x$ ?

- 1) 1
- 2) 3.6
- 3) 5
- 4) 10.25

- 24 What is the negation of the statement “Squares are parallelograms”?

- 1) Parallelograms are squares.
- 2) Parallelograms are not squares.
- 3) It is not the case that squares are parallelograms.
- 4) It is not the case that parallelograms are squares.

- 25 The diagram below shows the construction of the center of the circle circumscribed about  $\triangle ABC$ .

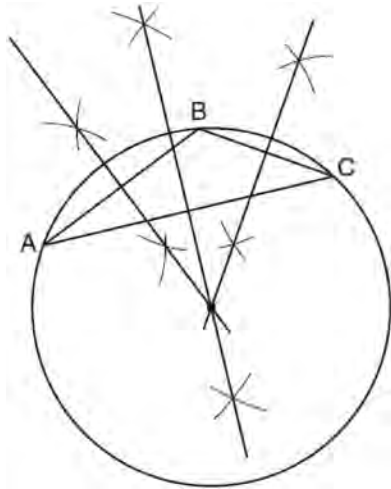

This construction represents how to find the intersection of

- 1) the angle bisectors of  $\triangle ABC$
  - 2) the medians to the sides of  $\triangle ABC$
  - 3) the altitudes to the sides of  $\triangle ABC$
  - 4) the perpendicular bisectors of the sides of  $\triangle ABC$
- 26 A right circular cylinder has a volume of 1,000 cubic inches and a height of 8 inches. What is the radius of the cylinder to the nearest tenth of an inch?
- 1) 6.3
  - 2) 11.2
  - 3) 19.8
  - 4) 39.8
- 27 If two different lines are perpendicular to the same plane, they are
- 1) collinear
  - 2) coplanar
  - 3) congruent
  - 4) consecutive

- 28 How many common tangent lines can be drawn to the two externally tangent circles shown below?

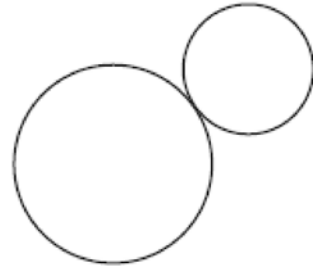

- 1) 1
  - 2) 2
  - 3) 3
  - 4) 4
- 29 In the diagram below of isosceles trapezoid  $DEFG$ ,  $\overline{DE} \parallel \overline{GF}$ ,  $DE = 4x - 2$ ,  $EF = 3x + 2$ ,  $FG = 5x - 3$ , and  $GD = 2x + 5$ . Find the value of  $x$ .

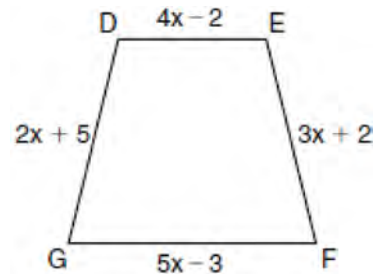

- 30 A regular pyramid with a square base is shown in the diagram below.

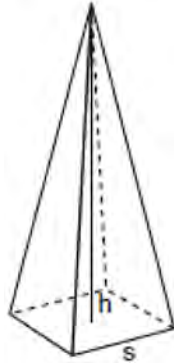

A side,  $s$ , of the base of the pyramid is 12 meters, and the height,  $h$ , is 42 meters. What is the volume of the pyramid in cubic meters?

- 31 Write an equation of the line that passes through the point  $(6, -5)$  and is parallel to the line whose equation is  $2x - 3y = 11$ .

- 32 Using a compass and straightedge, construct the angle bisector of  $\angle ABC$  shown below. [Leave all construction marks.]

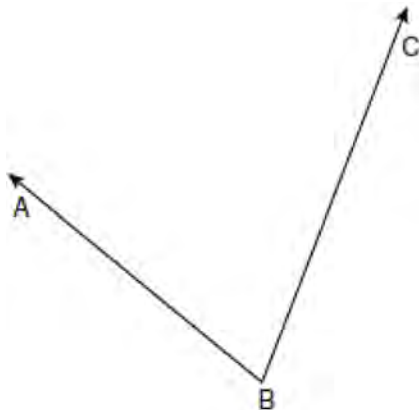

- 33 The degree measures of the angles of  $\triangle ABC$  are represented by  $x$ ,  $3x$ , and  $5x - 54$ . Find the value of  $x$ .

- 34 In the diagram below of  $\triangle ABC$  with side  $\overline{AC}$  extended through  $D$ ,  $m\angle A = 37$  and  $m\angle BCD = 117$ . Which side of  $\triangle ABC$  is the longest side? Justify your answer.

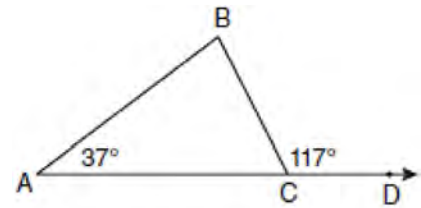

(Not drawn to scale)

- 35 Write an equation of the perpendicular bisector of the line segment whose endpoints are  $(-1, 1)$  and  $(7, -5)$ . [The use of the grid below is optional]

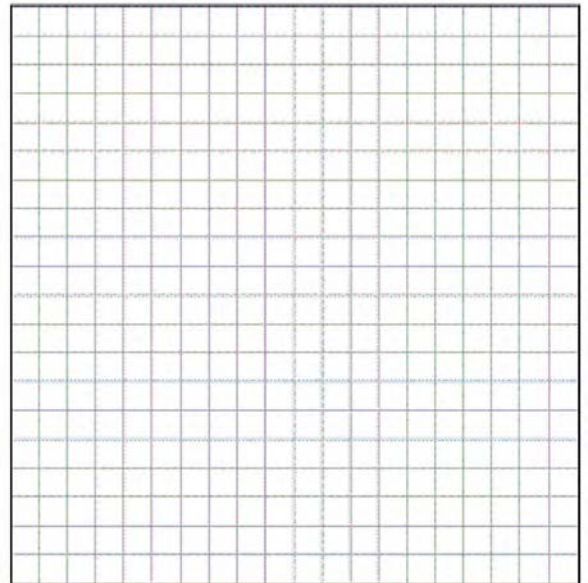



- 36 On the set of axes below, sketch the points that are 5 units from the origin and sketch the points that are 2 units from the line  $y = 3$ . Label with an **X** all points that satisfy both conditions.

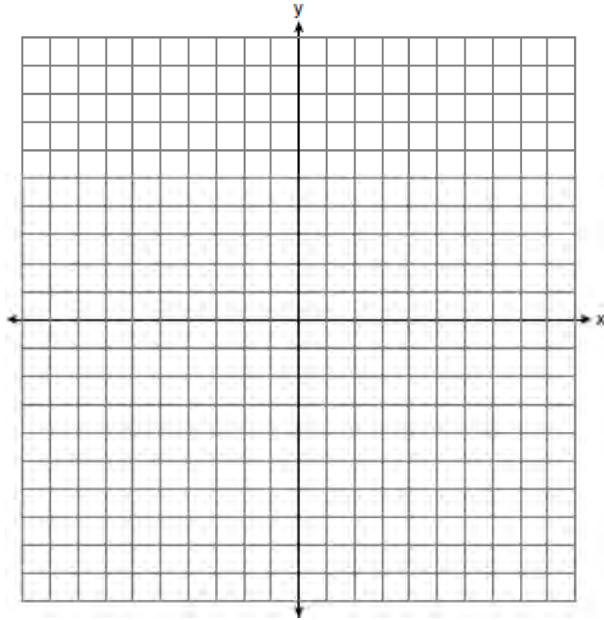

- 37 Triangle  $DEG$  has the coordinates  $D(1,1)$ ,  $E(5,1)$ , and  $G(5,4)$ . Triangle  $DEG$  is rotated  $90^\circ$  about the origin to form  $\triangle D'E'G'$ . On the grid below, graph and label  $\triangle DEG$  and  $\triangle D'E'G'$ . State the coordinates of the vertices  $D'$ ,  $E'$ , and  $G'$ . Justify that this transformation preserves distance.

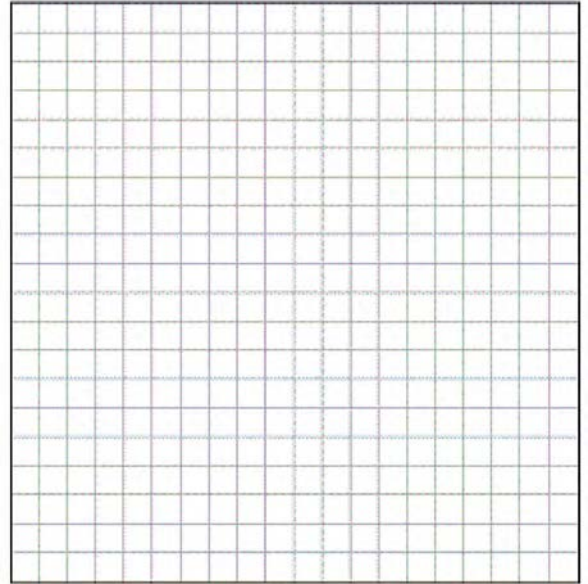

- 38 Given: Quadrilateral  $ABCD$ , diagonal  $\overline{AFEC}$ ,  $\overline{AE} \cong \overline{FC}$ ,  $\overline{BF} \perp \overline{AC}$ ,  $\overline{DE} \perp \overline{AC}$ ,  $\angle 1 \cong \angle 2$   
 Prove:  $ABCD$  is a parallelogram.

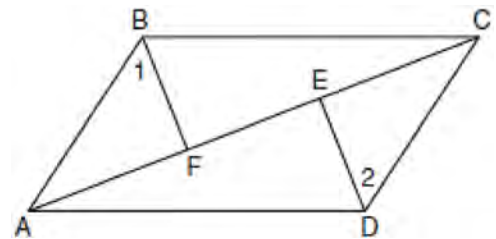

0110ge

- 1 In the diagram below of trapezoid  $RSUT$ ,  $\overline{RS} \parallel \overline{TU}$ ,  $X$  is the midpoint of  $\overline{RT}$ , and  $V$  is the midpoint of  $\overline{SU}$ .

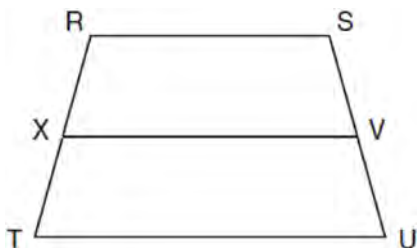

If  $RS = 30$  and  $XV = 44$ , what is the length of  $\overline{TU}$ ?

- 1) 37
  - 2) 58
  - 3) 74
  - 4) 118
- 2 In  $\triangle ABC$ ,  $m\angle A = x$ ,  $m\angle B = 2x + 2$ , and  $m\angle C = 3x + 4$ . What is the value of  $x$ ?
- 1) 29
  - 2) 31
  - 3) 59
  - 4) 61

- 3 Which expression best describes the transformation shown in the diagram below?

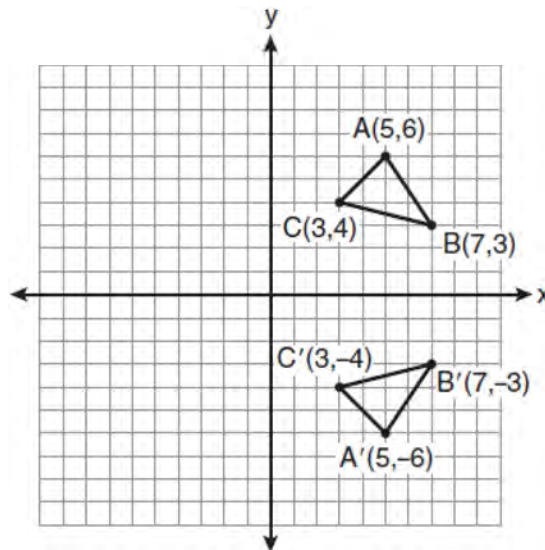

- 1) same orientation; reflection
- 2) opposite orientation; reflection
- 3) same orientation; translation
- 4) opposite orientation; translation

- 4 Based on the construction below, which statement must be true?

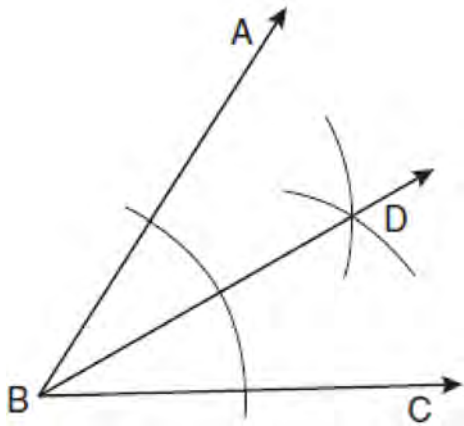

- 1)  $m\angle ABD = \frac{1}{2} m\angle CBD$
- 2)  $m\angle ABD = m\angle CBD$
- 3)  $m\angle ABD = m\angle ABC$
- 4)  $m\angle CBD = \frac{1}{2} m\angle ABD$

- 5 In the diagram below,  $\triangle ABC$  is inscribed in circle  $P$ . The distances from the center of circle  $P$  to each side of the triangle are shown.

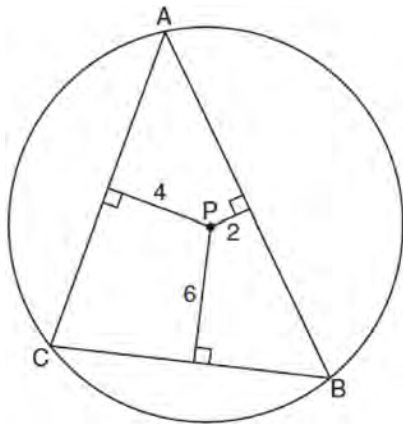

Which statement about the sides of the triangle is true?

- 1)  $AB > AC > BC$
- 2)  $AB < AC$  and  $AC > BC$
- 3)  $AC > AB > BC$
- 4)  $AC = AB$  and  $AB > BC$

- 6 Which transformation is *not* always an isometry?
- 1) rotation
  - 2) dilation
  - 3) reflection
  - 4) translation

- 7 In  $\triangle ABC$ ,  $\overline{AB} \cong \overline{BC}$ . An altitude is drawn from  $B$  to  $\overline{AC}$  and intersects  $\overline{AC}$  at  $D$ . Which conclusion is *not* always true?

- 1)  $\angle ABD \cong \angle CBD$
- 2)  $\angle BDA \cong \angle BDC$
- 3)  $\overline{AD} \cong \overline{BD}$
- 4)  $\overline{AD} \cong \overline{DC}$

- 8 In the diagram below, tangent  $\overline{PA}$  and secant  $\overline{PBC}$  are drawn to circle  $O$  from external point  $P$ .

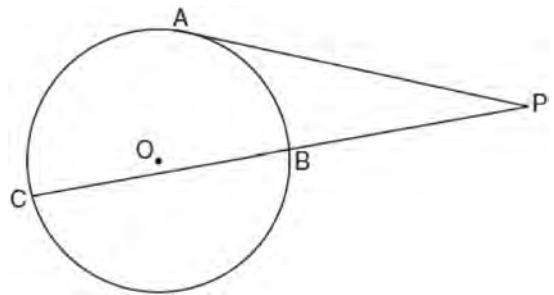

If  $PB = 4$  and  $BC = 5$ , what is the length of  $\overline{PA}$ ?

- 1) 20
- 2) 9
- 3) 8
- 4) 6

- 9 Which geometric principle is used to justify the construction below?

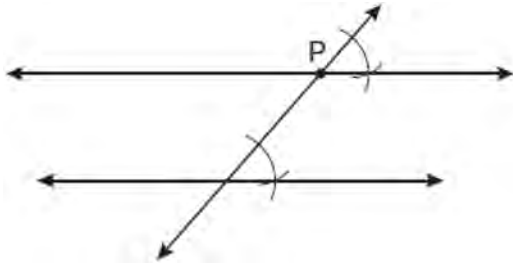

- 1) A line perpendicular to one of two parallel lines is perpendicular to the other.
  - 2) Two lines are perpendicular if they intersect to form congruent adjacent angles.
  - 3) When two lines are intersected by a transversal and alternate interior angles are congruent, the lines are parallel.
  - 4) When two lines are intersected by a transversal and the corresponding angles are congruent, the lines are parallel.
- 10 Which equation represents the circle whose center is  $(-2, 3)$  and whose radius is 5?
- 1)  $(x - 2)^2 + (y + 3)^2 = 5$
  - 2)  $(x + 2)^2 + (y - 3)^2 = 5$
  - 3)  $(x + 2)^2 + (y - 3)^2 = 25$
  - 4)  $(x - 2)^2 + (y + 3)^2 = 25$
- 11 Towns  $A$  and  $B$  are 16 miles apart. How many points are 10 miles from town  $A$  and 12 miles from town  $B$ ?
- 1) 1
  - 2) 2
  - 3) 3
  - 4) 0

- 12 Lines  $j$  and  $k$  intersect at point  $P$ . Line  $m$  is drawn so that it is perpendicular to lines  $j$  and  $k$  at point  $P$ . Which statement is correct?
- 1) Lines  $j$  and  $k$  are in perpendicular planes.
  - 2) Line  $m$  is in the same plane as lines  $j$  and  $k$ .
  - 3) Line  $m$  is parallel to the plane containing lines  $j$  and  $k$ .
  - 4) Line  $m$  is perpendicular to the plane containing lines  $j$  and  $k$ .

- 13 In the diagram below of parallelogram  $STUV$ ,  $SV = x + 3$ ,  $VU = 2x - 1$ , and  $TU = 4x - 3$ .

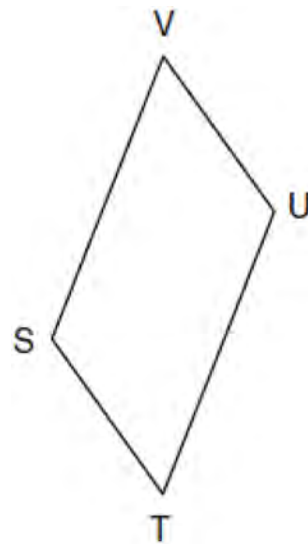

What is the length of  $\overline{SV}$ ?

- 1) 5
  - 2) 2
  - 3) 7
  - 4) 4
- 14 Which equation represents a line parallel to the line whose equation is  $2y - 5x = 10$ ?
- 1)  $5y - 2x = 25$
  - 2)  $5y + 2x = 10$
  - 3)  $4y - 10x = 12$
  - 4)  $2y + 10x = 8$

- 15 In the diagram below of circle  $O$ , chords  $\overline{AD}$  and  $\overline{BC}$  intersect at  $E$ ,  $m\widehat{AC} = 87$ , and  $m\widehat{BD} = 35$ .

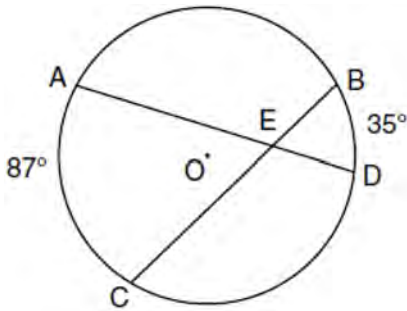

What is the degree measure of  $\angle CEA$ ?

- 1) 87
  - 2) 61
  - 3) 43.5
  - 4) 26
- 16 In the diagram below of  $\triangle ADB$ ,  $m\angle BDA = 90$ ,  $AD = 5\sqrt{2}$ , and  $AB = 2\sqrt{15}$ .

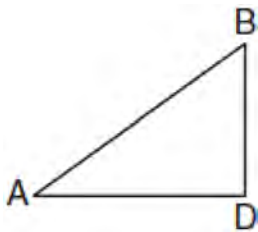

What is the length of  $\overline{BD}$ ?

- 1)  $\sqrt{10}$
  - 2)  $\sqrt{20}$
  - 3)  $\sqrt{50}$
  - 4)  $\sqrt{110}$
- 17 What is the distance between the points  $(-3,2)$  and  $(1,0)$ ?
- 1)  $2\sqrt{2}$
  - 2)  $2\sqrt{3}$
  - 3)  $5\sqrt{2}$
  - 4)  $2\sqrt{5}$

- 18 What is an equation of the line that contains the point  $(3,-1)$  and is perpendicular to the line whose equation is  $y = -3x + 2$ ?

- 1)  $y = -3x + 8$
- 2)  $y = -3x$
- 3)  $y = \frac{1}{3}x$
- 4)  $y = \frac{1}{3}x - 2$

- 19 In the diagram below,  $\overline{SQ}$  and  $\overline{PR}$  intersect at  $T$ ,  $\overline{PQ}$  is drawn, and  $\overline{PS} \parallel \overline{QR}$ .

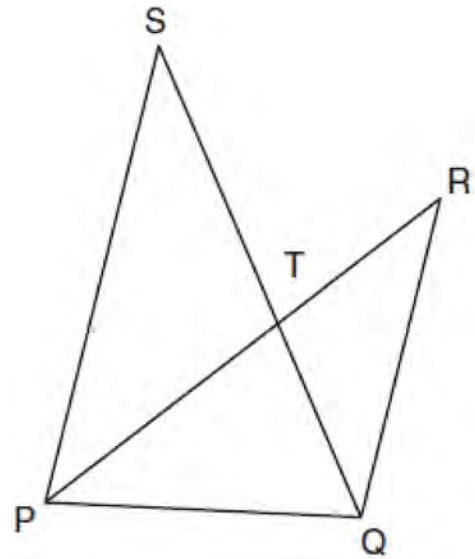

What technique can be used to prove that  $\triangle PST \sim \triangle RQT$ ?

- 1) SAS
- 2) SSS
- 3) ASA
- 4) AA

- 20 The equation of a circle is  $(x - 2)^2 + (y + 4)^2 = 4$ . Which diagram is the graph of the circle?

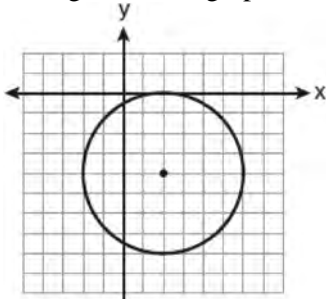

1)

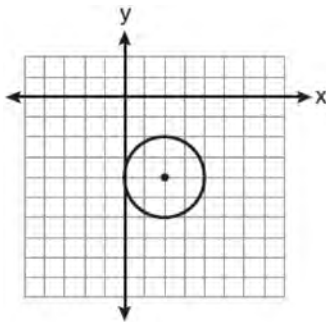

2)

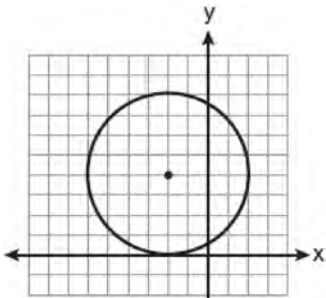

3)

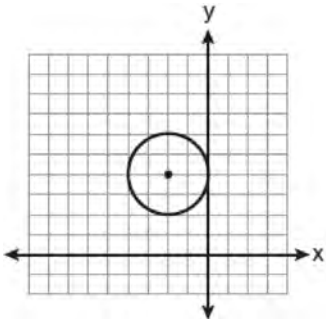

4)

- 21 In the diagram below,  $\triangle ABC$  is shown with  $\overline{AC}$  extended through point  $D$ .

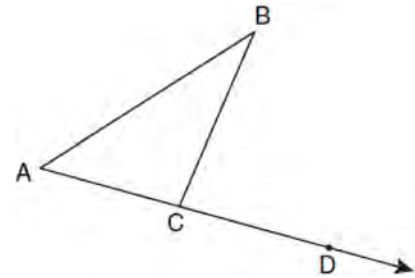

If  $m\angle BCD = 6x + 2$ ,  $m\angle BAC = 3x + 15$ , and  $m\angle ABC = 2x - 1$ , what is the value of  $x$ ?

- 1) 12
- 2)  $14\frac{10}{11}$
- 3) 16
- 4)  $18\frac{1}{9}$

- 22 Given  $\triangle ABC \sim \triangle DEF$  such that  $\frac{AB}{DE} = \frac{3}{2}$ . Which statement is *not* true?

- 1)  $\frac{BC}{EF} = \frac{3}{2}$
- 2)  $\frac{m\angle A}{m\angle D} = \frac{3}{2}$
- 3)  $\frac{\text{area of } \triangle ABC}{\text{area of } \triangle DEF} = \frac{9}{4}$
- 4)  $\frac{\text{perimeter of } \triangle ABC}{\text{perimeter of } \triangle DEF} = \frac{3}{2}$

- 23 The pentagon in the diagram below is formed by five rays.

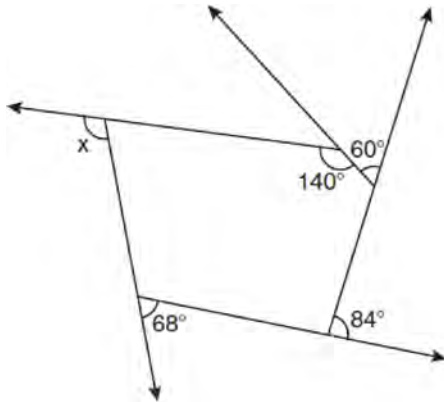

What is the degree measure of angle  $x$ ?

- 1) 72
  - 2) 96
  - 3) 108
  - 4) 112
- 24 Through a given point,  $P$ , on a plane, how many lines can be drawn that are perpendicular to that plane?
- 1) 1
  - 2) 2
  - 3) more than 2
  - 4) none
- 25 What is the slope of a line that is perpendicular to the line whose equation is  $3x + 4y = 12$ ?
- 1)  $\frac{3}{4}$
  - 2)  $-\frac{3}{4}$
  - 3)  $\frac{4}{3}$
  - 4)  $-\frac{4}{3}$

- 26 What is the image of point  $A(4,2)$  after the composition of transformations defined by  $R_{90^\circ} \circ r_{y=x}$ ?

- 1)  $(-4,2)$
- 2)  $(4,-2)$
- 3)  $(-4,-2)$
- 4)  $(2,-4)$

- 27 Which expression represents the volume, in cubic centimeters, of the cylinder represented in the diagram below?

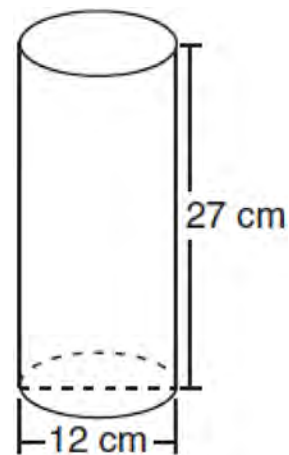

- 1)  $162\pi$
  - 2)  $324\pi$
  - 3)  $972\pi$
  - 4)  $3,888\pi$
- 28 What is the inverse of the statement “If two triangles are not similar, their corresponding angles are not congruent”?
- 1) If two triangles are similar, their corresponding angles are not congruent.
  - 2) If corresponding angles of two triangles are not congruent, the triangles are not similar.
  - 3) If two triangles are similar, their corresponding angles are congruent.
  - 4) If corresponding angles of two triangles are congruent, the triangles are similar.

29 In  $\triangle RST$ ,  $m\angle RST = 46$  and  $\overline{RS} \cong \overline{ST}$ . Find  $m\angle STR$ .

30 Tim has a rectangular prism with a length of 10 centimeters, a width of 2 centimeters, and an unknown height. He needs to build another rectangular prism with a length of 5 centimeters and the same height as the original prism. The volume of the two prisms will be the same. Find the width, in centimeters, of the new prism.

31 In the diagram below of circle  $C$ ,  $\overline{QR}$  is a diameter, and  $Q(1,8)$  and  $C(3.5,2)$  are points on a coordinate plane. Find and state the coordinates of point  $R$ .

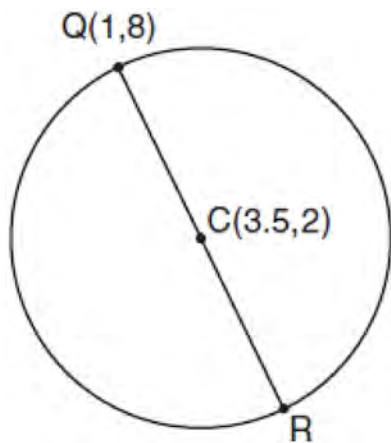

32 Using a compass and straightedge, and  $\overline{AB}$  below, construct an equilateral triangle with all sides congruent to  $\overline{AB}$ . [Leave all construction marks.]



33 In the diagram below of  $\triangle ACD$ ,  $E$  is a point on  $\overline{AD}$  and  $B$  is a point on  $\overline{AC}$ , such that  $\overline{EB} \parallel \overline{DC}$ . If  $\overline{AE} = 3$ ,  $\overline{ED} = 6$ , and  $\overline{DC} = 15$ , find the length of  $\overline{EB}$ .

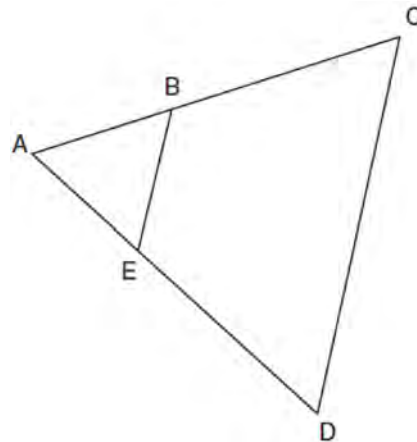

34 In the diagram below of  $\triangle TEM$ , medians  $\overline{TB}$ ,  $\overline{EC}$ , and  $\overline{MA}$  intersect at  $D$ , and  $\overline{TB} = 9$ . Find the length of  $\overline{TD}$ .

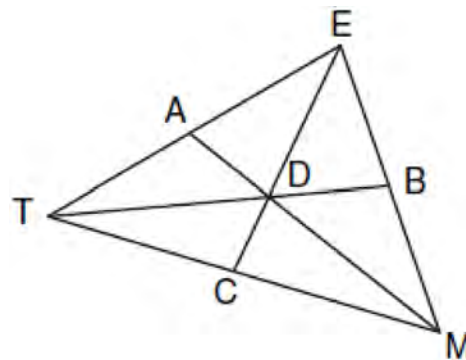

35 In  $\triangle KLM$ ,  $m\angle K = 36$  and  $\overline{KM} = 5$ . The transformation  $D_2$  is performed on  $\triangle KLM$  to form  $\triangle K'L'M'$ . Find  $m\angle K'$ . Justify your answer. Find the length of  $\overline{K'M'}$ . Justify your answer.



36 Given:  $\overline{JKLM}$  is a parallelogram.

$$\overline{JM} \cong \overline{LN}$$

$$\angle LMN \cong \angle LNM$$

Prove:  $\overline{JKLM}$  is a rhombus.

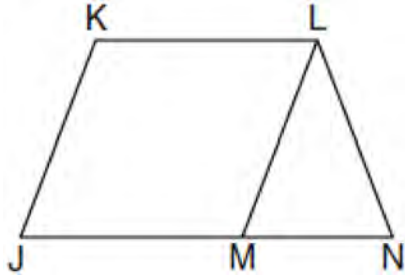

37 On the grid below, graph the points that are equidistant from both the  $x$  and  $y$  axes and the points that are 5 units from the origin. Label with an **X** all points that satisfy both conditions.

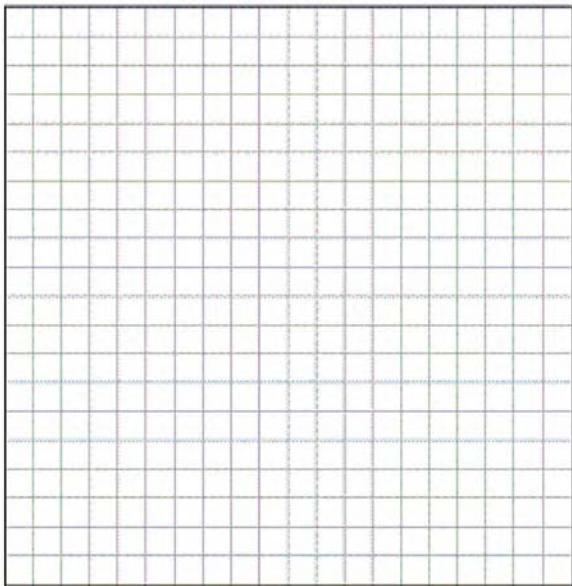

38 On the set of axes below, solve the following system of equations graphically for all values of  $x$  and  $y$ .

$$y = (x - 2)^2 + 4$$

$$4x + 2y = 14$$

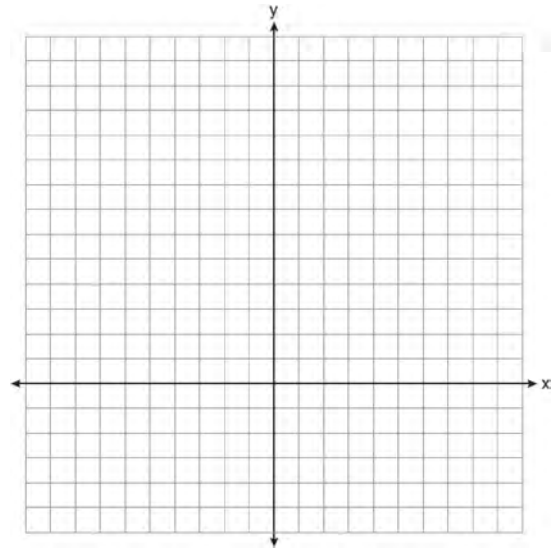

0610ge

- 1 In the diagram below of circle  $O$ , chord  $\overline{AB} \parallel$  chord  $\overline{CD}$ , and chord  $\overline{CD} \parallel$  chord  $\overline{EF}$ .

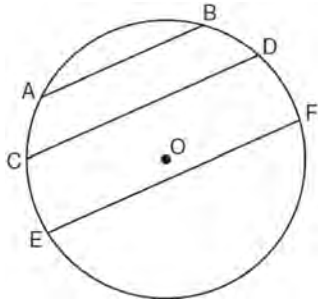

Which statement must be true?

- 1)  $\widehat{CE} \cong \widehat{DF}$
  - 2)  $\widehat{AC} \cong \widehat{DF}$
  - 3)  $\widehat{AC} \cong \widehat{CE}$
  - 4)  $\widehat{EF} \cong \widehat{CD}$
- 2 What is the negation of the statement “I am not going to eat ice cream”?
- 1) I like ice cream.
  - 2) I am going to eat ice cream.
  - 3) If I eat ice cream, then I like ice cream.
  - 4) If I don't like ice cream, then I don't eat ice cream.

- 3 The diagram below shows a right pentagonal prism.

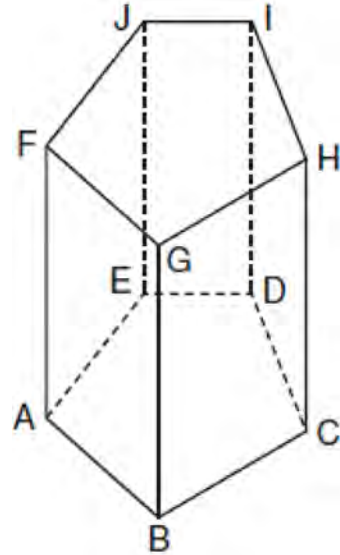

Which statement is always true?

- 1)  $\overline{BC} \parallel \overline{ED}$
  - 2)  $\overline{FG} \parallel \overline{CD}$
  - 3)  $\overline{FJ} \parallel \overline{IH}$
  - 4)  $\overline{GB} \parallel \overline{HC}$
- 4 In isosceles triangle  $ABC$ ,  $AB = BC$ . Which statement will always be true?
- 1)  $m\angle B = m\angle A$
  - 2)  $m\angle A > m\angle B$
  - 3)  $m\angle A = m\angle C$
  - 4)  $m\angle C < m\angle B$

- 5 The rectangle  $ABCD$  shown in the diagram below will be reflected across the  $x$ -axis.

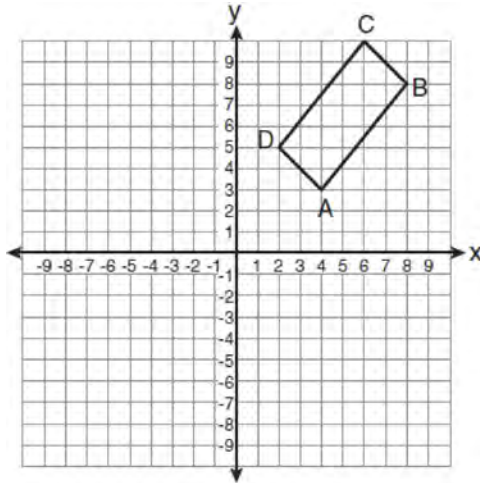

What will *not* be preserved?

- 1) slope of  $\overline{AB}$
  - 2) parallelism of  $\overline{AB}$  and  $\overline{CD}$
  - 3) length of  $\overline{AB}$
  - 4) measure of  $\angle A$
- 6 A right circular cylinder has an altitude of 11 feet and a radius of 5 feet. What is the lateral area, in square feet, of the cylinder, to the *nearest tenth*?
- 1) 172.7
  - 2) 172.8
  - 3) 345.4
  - 4) 345.6
- 7 A transversal intersects two lines. Which condition would always make the two lines parallel?
- 1) Vertical angles are congruent.
  - 2) Alternate interior angles are congruent.
  - 3) Corresponding angles are supplementary.
  - 4) Same-side interior angles are complementary.

- 8 If the diagonals of a quadrilateral do *not* bisect each other, then the quadrilateral could be a
- 1) rectangle
  - 2) rhombus
  - 3) square
  - 4) trapezoid
- 9 What is the converse of the statement "If Bob does his homework, then George gets candy"?
- 1) If George gets candy, then Bob does his homework.
  - 2) Bob does his homework if and only if George gets candy.
  - 3) If George does not get candy, then Bob does not do his homework.
  - 4) If Bob does not do his homework, then George does not get candy.
- 10 In  $\triangle PQR$ ,  $PQ = 8$ ,  $QR = 12$ , and  $RP = 13$ . Which statement about the angles of  $\triangle PQR$  must be true?
- 1)  $m\angle Q > m\angle P > m\angle R$
  - 2)  $m\angle Q > m\angle R > m\angle P$
  - 3)  $m\angle R > m\angle P > m\angle Q$
  - 4)  $m\angle P > m\angle R > m\angle Q$
- 11 Given:  $y = \frac{1}{4}x - 3$

$$y = x^2 + 8x + 12$$

In which quadrant will the graphs of the given equations intersect?

- 1) I
- 2) II
- 3) III
- 4) IV

- 12 Which diagram shows the construction of an equilateral triangle?

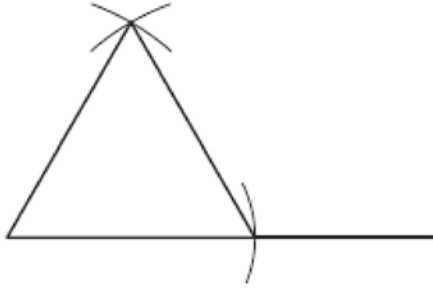

1)

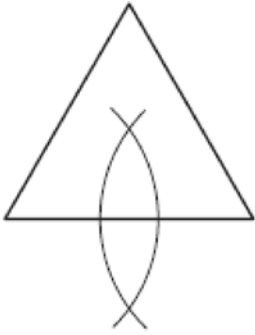

2)

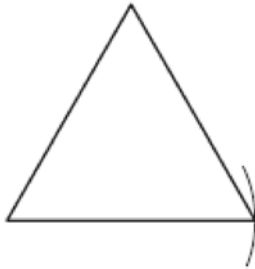

3)

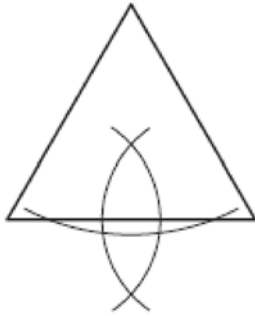

4)

- 13 Line segment  $AB$  is tangent to circle  $O$  at  $A$ . Which type of triangle is always formed when points  $A$ ,  $B$ , and  $O$  are connected?

- 1) right
- 2) obtuse
- 3) scalene
- 4) isosceles

- 14 What is an equation for the circle shown in the graph below?

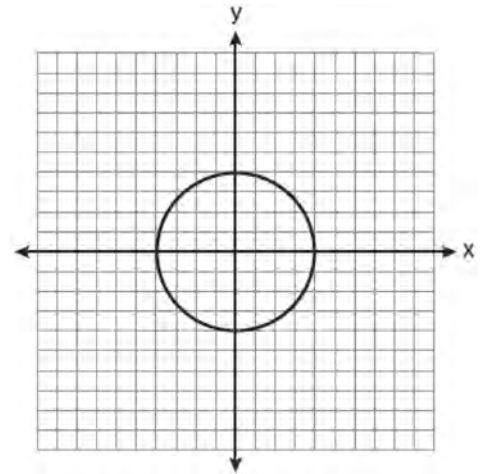

- 1)  $x^2 + y^2 = 2$
- 2)  $x^2 + y^2 = 4$
- 3)  $x^2 + y^2 = 8$
- 4)  $x^2 + y^2 = 16$

- 15 Which transformation can map the letter **S** onto itself?

- 1) glide reflection
- 2) translation
- 3) line reflection
- 4) rotation

- 16 In isosceles trapezoid  $ABCD$ ,  $\overline{AB} \cong \overline{CD}$ . If  $BC = 20$ ,  $AD = 36$ , and  $AB = 17$ , what is the length of the altitude of the trapezoid?
- 1) 10
  - 2) 12
  - 3) 15
  - 4) 16

- 17 In plane  $\mathcal{P}$ , lines  $m$  and  $n$  intersect at point  $A$ . If line  $k$  is perpendicular to line  $m$  and line  $n$  at point  $A$ , then line  $k$  is
- 1) contained in plane  $\mathcal{P}$
  - 2) parallel to plane  $\mathcal{P}$
  - 3) perpendicular to plane  $\mathcal{P}$
  - 4) skew to plane  $\mathcal{P}$

- 18 The diagram below shows  $\overline{AB}$  and  $\overline{DE}$ .

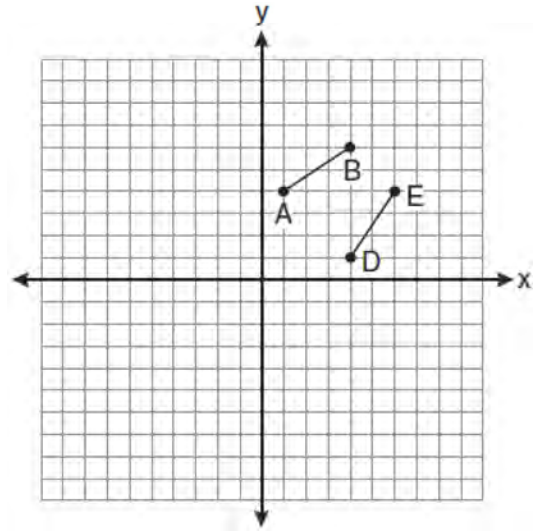

Which transformation will move  $\overline{AB}$  onto  $\overline{DE}$  such that point  $D$  is the image of point  $A$  and point  $E$  is the image of point  $B$ ?

- 1)  $T_{3,-3}$
- 2)  $D_{\frac{1}{2}}$
- 3)  $R_{90^\circ}$
- 4)  $r_{y=x}$

- 19 In the diagram below of circle  $O$ , chords  $\overline{AE}$  and  $\overline{DC}$  intersect at point  $B$ , such that  $m\widehat{AC} = 36$  and  $m\widehat{DE} = 20$ .

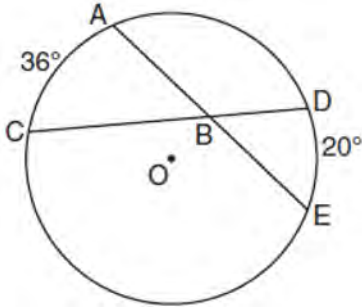

What is  $m\angle ABC$ ?

- 1) 56
- 2) 36
- 3) 28
- 4) 8

- 20 The diagram below shows the construction of a line through point  $P$  perpendicular to line  $m$ .

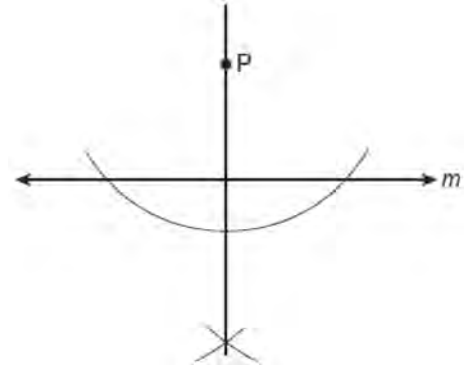

Which statement is demonstrated by this construction?

- 1) If a line is parallel to a line that is perpendicular to a third line, then the line is also perpendicular to the third line.
  - 2) The set of points equidistant from the endpoints of a line segment is the perpendicular bisector of the segment.
  - 3) Two lines are perpendicular if they are equidistant from a given point.
  - 4) Two lines are perpendicular if they intersect to form a vertical line.
- 21 What is the length, to the *nearest tenth*, of the line segment joining the points  $(-4, 2)$  and  $(146, 52)$ ?
- 1) 141.4
  - 2) 150.5
  - 3) 151.9
  - 4) 158.1
- 22 What is the slope of a line perpendicular to the line whose equation is  $y = 3x + 4$ ?
- 1)  $\frac{1}{3}$
  - 2)  $-\frac{1}{3}$
  - 3) 3
  - 4) -3

- 23 In the diagram below of circle  $O$ , secant  $\overline{AB}$  intersects circle  $O$  at  $D$ , secant  $\overline{AOC}$  intersects circle  $O$  at  $E$ ,  $AE = 4$ ,  $AB = 12$ , and  $DB = 6$ .

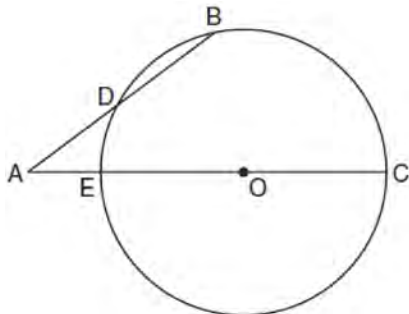

(Not drawn to scale)

What is the length of  $\overline{OC}$ ?

- 1) 4.5
  - 2) 7
  - 3) 9
  - 4) 14
- 24 The diagram below shows a pennant in the shape of an isosceles triangle. The equal sides each measure 13, the altitude is  $x + 7$ , and the base is  $2x$ .

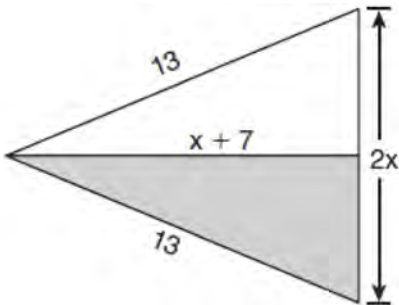

What is the length of the base?

- 1) 5
- 2) 10
- 3) 12
- 4) 24

- 25 In the diagram below of  $\triangle ABC$ ,  $\overline{CD}$  is the bisector of  $\angle BCA$ ,  $\overline{AE}$  is the bisector of  $\angle CAB$ , and  $\overline{BG}$  is drawn.

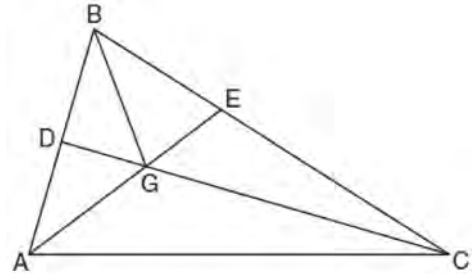

Which statement must be true?

- 1)  $DG = EG$
  - 2)  $AG = BG$
  - 3)  $\angle AEB \cong \angle AEC$
  - 4)  $\angle DBG \cong \angle EBG$
- 26 In the diagram below of circle  $O$ , chords  $\overline{AD}$  and  $\overline{BC}$  intersect at  $E$ .

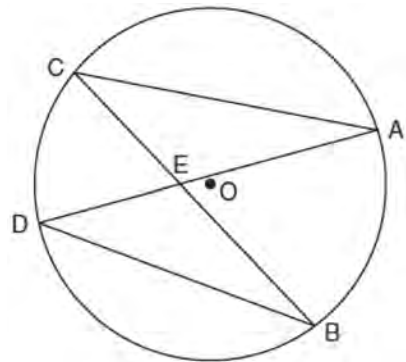

Which relationship must be true?

- 1)  $\triangle CAE \cong \triangle DBE$
- 2)  $\triangle AEC \sim \triangle BED$
- 3)  $\angle ACB \cong \angle CBD$
- 4)  $\widehat{CA} \cong \widehat{DB}$

- 27 Two lines are represented by the equations  $-\frac{1}{2}y = 6x + 10$  and  $y = mx$ . For which value of  $m$  will the lines be parallel?
- 1)  $-12$
  - 2)  $-3$
  - 3)  $3$
  - 4)  $12$

- 28 The coordinates of the vertices of parallelogram  $ABCD$  are  $A(-3,2)$ ,  $B(-2,-1)$ ,  $C(4,1)$ , and  $D(3,4)$ . The slopes of which line segments could be calculated to show that  $ABCD$  is a rectangle?
- 1)  $\overline{AB}$  and  $\overline{DC}$
  - 2)  $\overline{AB}$  and  $\overline{BC}$
  - 3)  $\overline{AD}$  and  $\overline{BC}$
  - 4)  $\overline{AC}$  and  $\overline{BD}$

- 29 Tim is going to paint a wooden sphere that has a diameter of 12 inches. Find the surface area of the sphere, to the nearest square inch.

- 30 In the diagram below of  $\triangle ABC$ ,  $\overline{DE}$  is a midsegment of  $\triangle ABC$ ,  $DE = 7$ ,  $AB = 10$ , and  $BC = 13$ . Find the perimeter of  $\triangle ABC$ .

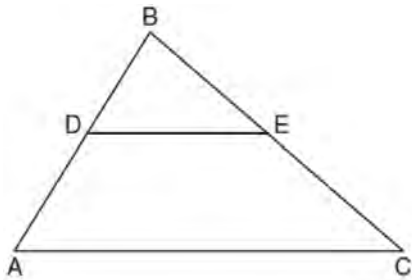

- 31 In right  $\triangle DEF$ ,  $m\angle D = 90$  and  $m\angle F$  is 12 degrees less than twice  $m\angle E$ . Find  $m\angle E$ .

- 32 Triangle  $XYZ$ , shown in the diagram below, is reflected over the line  $x = 2$ . State the coordinates of  $\triangle X'Y'Z'$ , the image of  $\triangle XYZ$ .

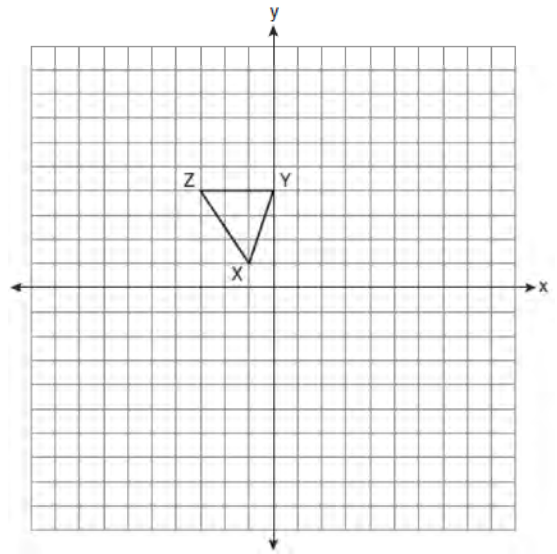

- 33 Two lines,  $\overleftrightarrow{AB}$  and  $\overleftrightarrow{CRD}$ , are parallel and 10 inches apart. Sketch the locus of all points that are equidistant from  $\overleftrightarrow{AB}$  and  $\overleftrightarrow{CRD}$  and 7 inches from point  $R$ . Label with an **X** each point that satisfies both conditions.

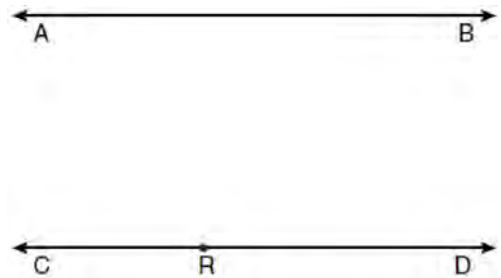



34 The base of a pyramid is a rectangle with a width of 6 cm and a length of 8 cm. Find, in centimeters, the height of the pyramid if the volume is  $288 \text{ cm}^3$ .

35 Given: Quadrilateral  $ABCD$  with  $\overline{AB} \cong \overline{CD}$ ,  $\overline{AD} \cong \overline{BC}$ , and diagonal  $\overline{BD}$  is drawn  
 Prove:  $\angle BDC \cong \angle ABD$

36 Find an equation of the line passing through the point  $(6,5)$  and perpendicular to the line whose equation is  $2y + 3x = 6$ .

37 Write an equation of the circle whose diameter  $\overline{AB}$  has endpoints  $A(-4,2)$  and  $B(4,-4)$ . [The use of the grid below is optional.]

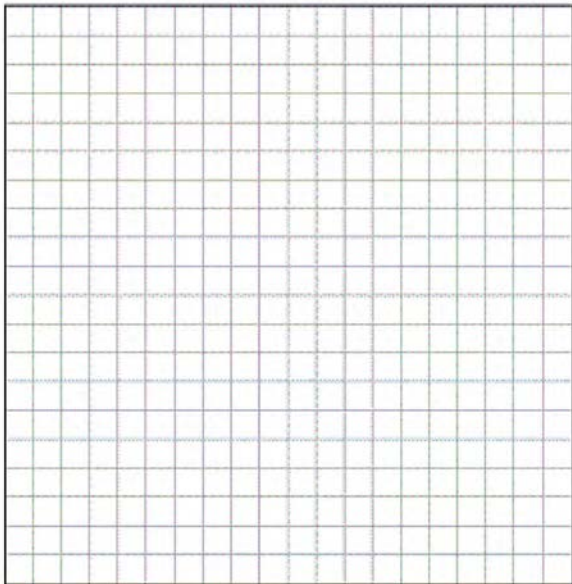

38 In the diagram below, quadrilateral  $STAR$  is a rhombus with diagonals  $\overline{SA}$  and  $\overline{TR}$  intersecting at  $E$ .  $ST = 3x + 30$ ,  $SR = 8x - 5$ ,  $SE = 3z$ ,  $TE = 5z + 5$ ,  $AE = 4z - 8$ ,  $m\angle RTA = 5y - 2$ , and  $m\angle TAS = 9y + 8$ . Find  $SR$ ,  $RT$ , and  $m\angle TAS$ .

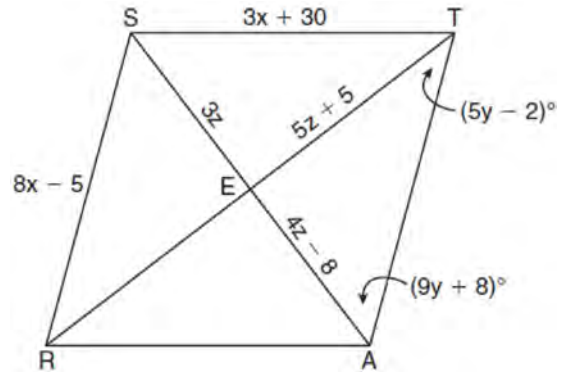

0810ge

- 1 In the diagram below,  $\triangle ABC \cong \triangle XYZ$ .

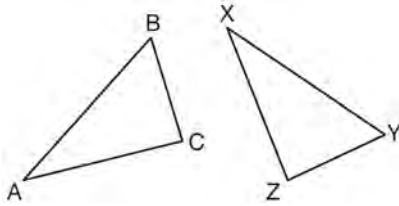

Which two statements identify corresponding congruent parts for these triangles?

- 1)  $\overline{AB} \cong \overline{XY}$  and  $\angle C \cong \angle Y$
  - 2)  $\overline{AB} \cong \overline{YZ}$  and  $\angle C \cong \angle X$
  - 3)  $\overline{BC} \cong \overline{XY}$  and  $\angle A \cong \angle Y$
  - 4)  $\overline{BC} \cong \overline{YZ}$  and  $\angle A \cong \angle X$
- 2 A support beam between the floor and ceiling of a house forms a  $90^\circ$  angle with the floor. The builder wants to make sure that the floor and ceiling are parallel. Which angle should the support beam form with the ceiling?
- 1)  $45^\circ$
  - 2)  $60^\circ$
  - 3)  $90^\circ$
  - 4)  $180^\circ$

- 3 In the diagram below, the vertices of  $\triangle DEF$  are the midpoints of the sides of equilateral triangle  $ABC$ , and the perimeter of  $\triangle ABC$  is 36 cm.

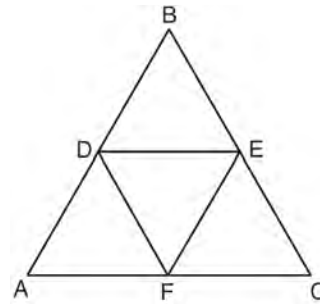

What is the length, in centimeters, of  $\overline{EF}$ ?

- 1) 6
  - 2) 12
  - 3) 18
  - 4) 4
- 4 What is the solution of the following system of equations?
- $$y = (x + 3)^2 - 4$$
- $$y = 2x + 5$$
- 1)  $(0, -4)$
  - 2)  $(-4, 0)$
  - 3)  $(-4, -3)$  and  $(0, 5)$
  - 4)  $(-3, -4)$  and  $(5, 0)$

- 5 One step in a construction uses the endpoints of  $\overline{AB}$  to create arcs with the same radii. The arcs intersect above and below the segment. What is the relationship of  $\overline{AB}$  and the line connecting the points of intersection of these arcs?
- 1) collinear
  - 2) congruent
  - 3) parallel
  - 4) perpendicular

- 6 If  $\triangle ABC \sim \triangle ZXY$ ,  $m\angle A = 50$ , and  $m\angle C = 30$ , what is  $m\angle X$ ?
- 1) 30
  - 2) 50
  - 3) 80
  - 4) 100

- 7 In the diagram below of  $\triangle AGE$  and  $\triangle OLD$ ,  $\angle GAE \cong \angle LOD$ , and  $\overline{AE} \cong \overline{OD}$ .

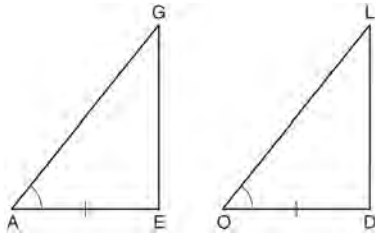

To prove that  $\triangle AGE$  and  $\triangle OLD$  are congruent by SAS, what other information is needed?

- 1)  $\overline{GE} \cong \overline{LD}$
  - 2)  $\overline{AG} \cong \overline{OL}$
  - 3)  $\angle AGE \cong \angle OLD$
  - 4)  $\angle AEG \cong \angle ODL$
- 8 Point  $A$  is not contained in plane  $B$ . How many lines can be drawn through point  $A$  that will be perpendicular to plane  $B$ ?
- 1) one
  - 2) two
  - 3) zero
  - 4) infinite
- 9 The equation of a circle is  $x^2 + (y - 7)^2 = 16$ . What are the center and radius of the circle?
- 1) center =  $(0, 7)$ ; radius = 4
  - 2) center =  $(0, 7)$ ; radius = 16
  - 3) center =  $(0, -7)$ ; radius = 4
  - 4) center =  $(0, -7)$ ; radius = 16

- 10 What is an equation of the line that passes through the point  $(7, 3)$  and is parallel to the line  $4x + 2y = 10$ ?

- 1)  $y = \frac{1}{2}x - \frac{1}{2}$
  - 2)  $y = -\frac{1}{2}x + \frac{13}{2}$
  - 3)  $y = 2x - 11$
  - 4)  $y = -2x + 17$
- 11 In  $\triangle ABC$ ,  $AB = 7$ ,  $BC = 8$ , and  $AC = 9$ . Which list has the angles of  $\triangle ABC$  in order from smallest to largest?
- 1)  $\angle A, \angle B, \angle C$
  - 2)  $\angle B, \angle A, \angle C$
  - 3)  $\angle C, \angle B, \angle A$
  - 4)  $\angle C, \angle A, \angle B$

- 12 Tangents  $\overline{PA}$  and  $\overline{PB}$  are drawn to circle  $O$  from an external point,  $P$ , and radii  $\overline{OA}$  and  $\overline{OB}$  are drawn. If  $m\angle APB = 40$ , what is the measure of  $\angle AOB$ ?
- 1)  $140^\circ$
  - 2)  $100^\circ$
  - 3)  $70^\circ$
  - 4)  $50^\circ$

- 13 What is the length of the line segment with endpoints  $(-6, 4)$  and  $(2, -5)$ ?
- 1)  $\sqrt{13}$
  - 2)  $\sqrt{17}$
  - 3)  $\sqrt{72}$
  - 4)  $\sqrt{145}$

- 14 The lines represented by the equations  $y + \frac{1}{2}x = 4$  and  $3x + 6y = 12$  are
- 1) the same line
  - 2) parallel
  - 3) perpendicular
  - 4) neither parallel nor perpendicular

- 15 A transformation of a polygon that always preserves both length and orientation is
- 1) dilation
  - 2) translation
  - 3) line reflection
  - 4) glide reflection

- 16 In which polygon does the sum of the measures of the interior angles equal the sum of the measures of the exterior angles?
- 1) triangle
  - 2) hexagon
  - 3) octagon
  - 4) quadrilateral

- 17 In the diagram below of circle  $O$ , chords  $\overline{AB}$  and  $\overline{CD}$  intersect at  $E$ .

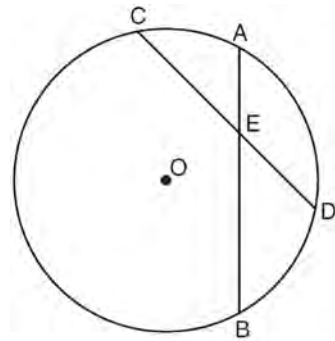

If  $\overline{CE} = 10$ ,  $\overline{ED} = 6$ , and  $\overline{AE} = 4$ , what is the length of  $\overline{EB}$ ?

- 1) 15
  - 2) 12
  - 3) 6.7
  - 4) 2.4
- 18 In the diagram below of  $\triangle ABC$ , medians  $\overline{AD}$ ,  $\overline{BE}$ , and  $\overline{CF}$  intersect at  $G$ .

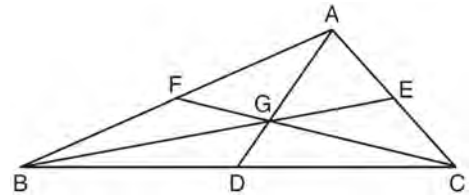

If  $\overline{CF} = 24$ , what is the length of  $\overline{FG}$ ?

- 1) 8
- 2) 10
- 3) 12
- 4) 16

- 19 If a line segment has endpoints  $A(3x + 5, 3y)$  and  $B(x - 1, -y)$ , what are the coordinates of the midpoint of  $\overline{AB}$ ?
- 1)  $(x + 3, 2y)$
  - 2)  $(2x + 2, y)$
  - 3)  $(2x + 3, y)$
  - 4)  $(4x + 4, 2y)$
- 20 If the surface area of a sphere is represented by  $144\pi$ , what is the volume in terms of  $\pi$ ?
- 1)  $36\pi$
  - 2)  $48\pi$
  - 3)  $216\pi$
  - 4)  $288\pi$
- 21 Which transformation of the line  $x = 3$  results in an image that is perpendicular to the given line?
- 1)  $r_{x\text{-axis}}$
  - 2)  $r_{y\text{-axis}}$
  - 3)  $r_{y=x}$
  - 4)  $r_{x=1}$

- 22 In the diagram below of regular pentagon  $ABCDE$ ,  $\overline{EB}$  is drawn.

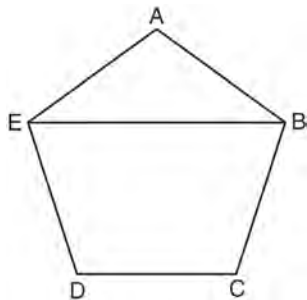

What is the measure of  $\angle AEB$ ?

- 1)  $36^\circ$
- 2)  $54^\circ$
- 3)  $72^\circ$
- 4)  $108^\circ$

- 23  $\triangle ABC$  is similar to  $\triangle DEF$ . The ratio of the length of  $\overline{AB}$  to the length of  $\overline{DE}$  is 3:1. Which ratio is also equal to 3:1?
- 1)  $\frac{m\angle A}{m\angle D}$
  - 2)  $\frac{m\angle B}{m\angle F}$
  - 3)  $\frac{\text{area of } \triangle ABC}{\text{area of } \triangle DEF}$
  - 4)  $\frac{\text{perimeter of } \triangle ABC}{\text{perimeter of } \triangle DEF}$

- 24 What is the slope of a line perpendicular to the line whose equation is  $2y = -6x + 8$ ?
- 1)  $-3$
  - 2)  $\frac{1}{6}$
  - 3)  $\frac{1}{3}$
  - 4)  $-6$

- 25 In the diagram below of circle  $C$ ,  $m\widehat{QT} = 140$ , and  $m\angle P = 40$ .

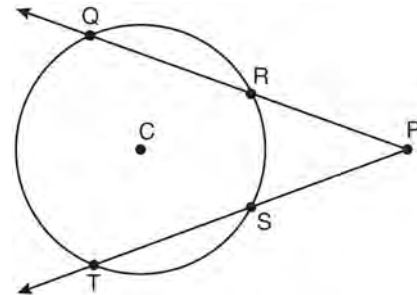

What is  $m\widehat{RS}$ ?

- 1) 50
- 2) 60
- 3) 90
- 4) 110

- 26 Which statement is logically equivalent to "If it is warm, then I go swimming"
- 1) If I go swimming, then it is warm.
  - 2) If it is warm, then I do not go swimming.
  - 3) If I do not go swimming, then it is not warm.
  - 4) If it is not warm, then I do not go swimming.

- 27 In the diagram below of  $\triangle ACT$ ,  $\overleftrightarrow{BE} \parallel \overleftrightarrow{AT}$ .

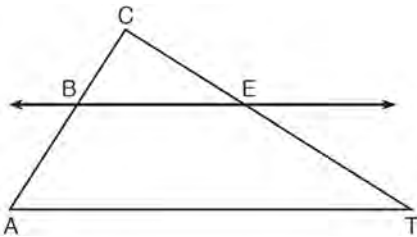

If  $CB = 3$ ,  $CA = 10$ , and  $CE = 6$ , what is the length of  $\overline{ET}$ ?

- 1) 5
- 2) 14
- 3) 20
- 4) 26

- 28 Which geometric principle is used in the construction shown below?

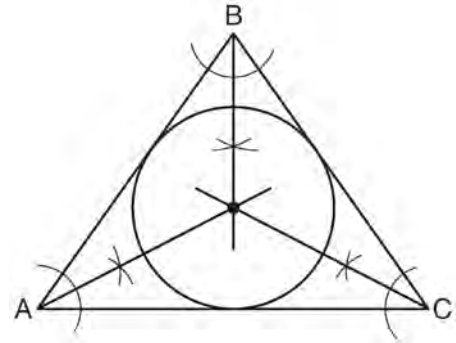

- 1) The intersection of the angle bisectors of a triangle is the center of the inscribed circle.
- 2) The intersection of the angle bisectors of a triangle is the center of the circumscribed circle.
- 3) The intersection of the perpendicular bisectors of the sides of a triangle is the center of the inscribed circle.
- 4) The intersection of the perpendicular bisectors of the sides of a triangle is the center of the circumscribed circle.

- 29 The diagram below shows isosceles trapezoid  $ABCD$  with  $\overline{AB} \parallel \overline{DC}$  and  $\overline{AD} \cong \overline{BC}$ . If  $m\angle BAD = 2x$  and  $m\angle BCD = 3x + 5$ , find  $m\angle BAD$ .

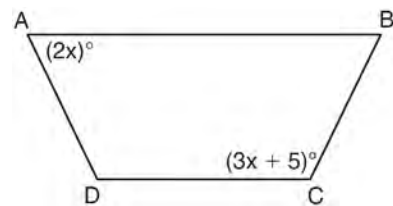

- 30 A right circular cone has a base with a radius of 15 cm, a vertical height of 20 cm, and a slant height of 25 cm. Find, in terms of  $\pi$ , the number of square centimeters in the lateral area of the cone.

- 31 In the diagram below of  $\triangle HQP$ , side  $\overline{HP}$  is extended through  $P$  to  $T$ ,  $m\angle QPT = 6x + 20$ ,  $m\angle HQP = x + 40$ , and  $m\angle PHQ = 4x - 5$ . Find  $m\angle QPT$ .

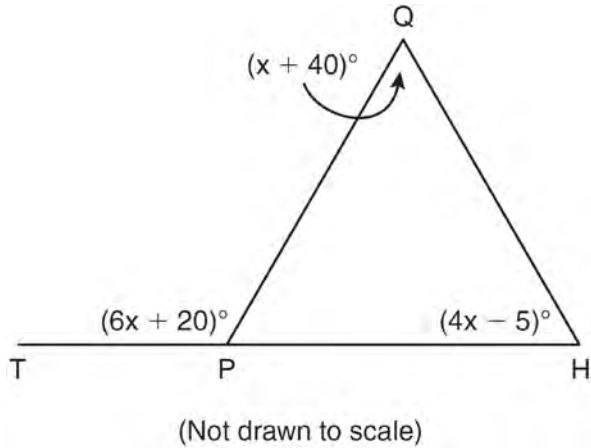

- 32 On the line segment below, use a compass and straightedge to construct equilateral triangle  $ABC$ . [Leave all construction marks.]



- 33 In the diagram below, car A is parked 7 miles from car B. Sketch the points that are 4 miles from car A and sketch the points that are 4 miles from car B. Label with an **X** all points that satisfy both conditions.



- 34 Write an equation for circle  $O$  shown on the graph below.

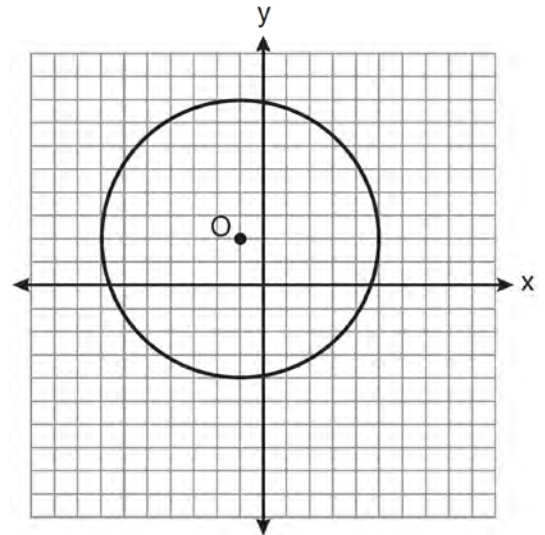

- 35 In the diagram below of quadrilateral  $ABCD$  with diagonal  $\overline{BD}$ ,  $m\angle A = 93$ ,  $m\angle ADB = 43$ ,  $m\angle C = 3x + 5$ ,  $m\angle BDC = x + 19$ , and  $m\angle DBC = 2x + 6$ . Determine if  $\overline{AB}$  is parallel to  $\overline{DC}$ . Explain your reasoning.

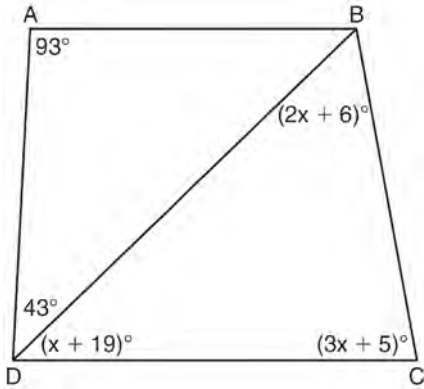

- 36 The coordinates of the vertices of  $\triangle ABC$  are  $A(1,3)$ ,  $B(-2,2)$  and  $C(0,-2)$ . On the grid below, graph and label  $\triangle A''B''C''$ , the result of the composite transformation  $D_2 \circ T_{3,-2}$ . State the coordinates of  $A''$ ,  $B''$ , and  $C''$ .

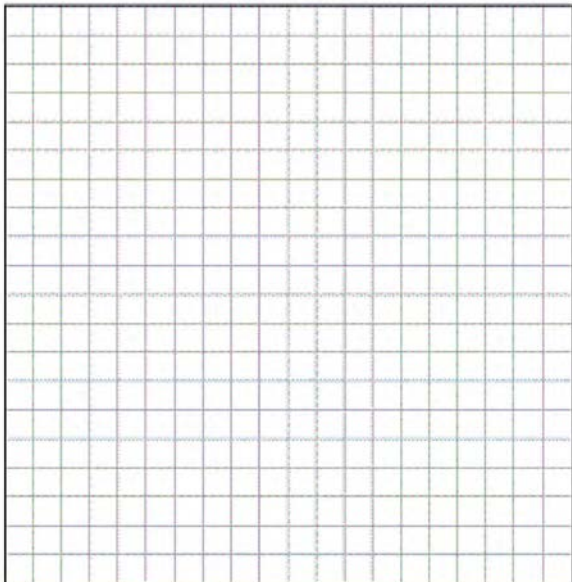

- 37 In the diagram below,  $\triangle RST$  is a 3-4-5 right triangle. The altitude,  $h$ , to the hypotenuse has been drawn. Determine the length of  $h$ .

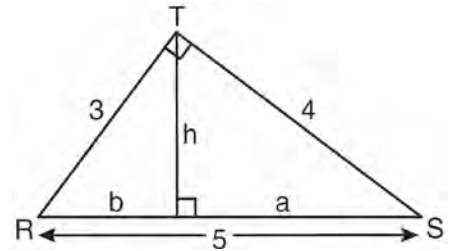

- 38 Given: Quadrilateral  $ABCD$  has vertices  $A(-5,6)$ ,  $B(6,6)$ ,  $C(8,-3)$ , and  $D(-3,-3)$ . Prove: Quadrilateral  $ABCD$  is a parallelogram but is neither a rhombus nor a rectangle. [The use of the grid below is optional.]

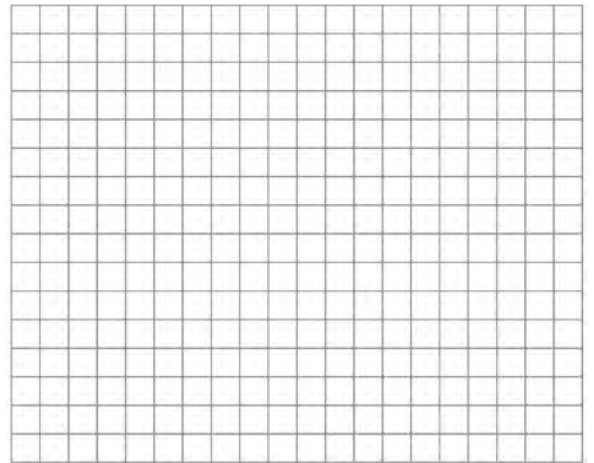



0111ge

- 1 In the diagram below,  $\overline{AB}$ ,  $\overline{BC}$ , and  $\overline{AC}$  are tangents to circle  $O$  at points  $F$ ,  $E$ , and  $D$ , respectively,  $AF = 6$ ,  $CD = 5$ , and  $BE = 4$ .

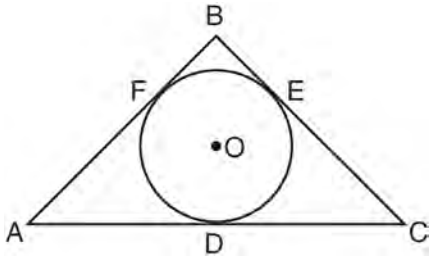

What is the perimeter of  $\triangle ABC$ ?

- 1) 15
  - 2) 25
  - 3) 30
  - 4) 60
- 2 Quadrilateral  $MNOP$  is a trapezoid with  $\overline{MN} \parallel \overline{OP}$ . If  $M'N'O'P'$  is the image of  $MNOP$  after a reflection over the  $x$ -axis, which two sides of quadrilateral  $M'N'O'P'$  are parallel?
- 1)  $\overline{M'N'}$  and  $\overline{O'P'}$
  - 2)  $\overline{M'N'}$  and  $\overline{N'O'}$
  - 3)  $\overline{P'M'}$  and  $\overline{O'P'}$
  - 4)  $\overline{P'M'}$  and  $\overline{N'O'}$

- 3 In the diagram below of  $\triangle ABC$ ,  $D$  is the midpoint of  $\overline{AB}$ , and  $E$  is the midpoint of  $\overline{BC}$ .

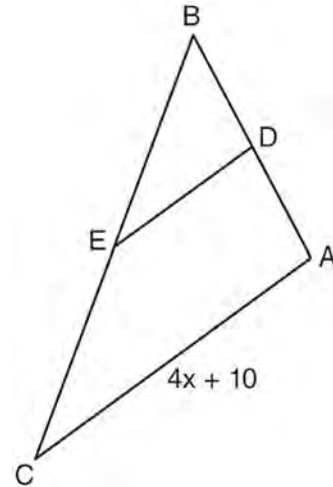

If  $AC = 4x + 10$ , which expression represents  $DE$ ?

- 1)  $x + 2.5$
  - 2)  $2x + 5$
  - 3)  $2x + 10$
  - 4)  $8x + 20$
- 4 Which statement is true about every parallelogram?
- 1) All four sides are congruent.
  - 2) The interior angles are all congruent.
  - 3) Two pairs of opposite sides are congruent.
  - 4) The diagonals are perpendicular to each other.

- 5 The diagram below shows a rectangular prism.

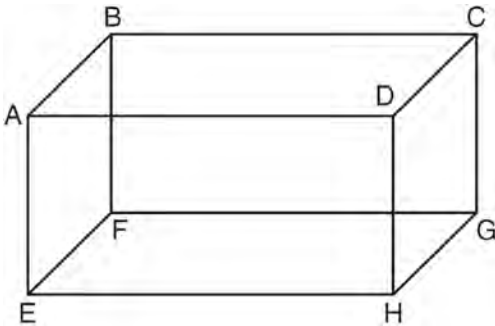

Which pair of edges are segments of lines that are coplanar?

- 1)  $\overline{AB}$  and  $\overline{DH}$
  - 2)  $\overline{AE}$  and  $\overline{DC}$
  - 3)  $\overline{BC}$  and  $\overline{EH}$
  - 4)  $\overline{CG}$  and  $\overline{EF}$
- 6 A line segment has endpoints  $A(7, -1)$  and  $B(-3, 3)$ . What are the coordinates of the midpoint of  $\overline{AB}$ ?
- 1)  $(1, 2)$
  - 2)  $(2, 1)$
  - 3)  $(-5, 2)$
  - 4)  $(5, -2)$
- 7 What is the image of the point  $(-5, 2)$  under the translation  $T_{3, -4}$ ?
- 1)  $(-9, 5)$
  - 2)  $(-8, 6)$
  - 3)  $(-2, -2)$
  - 4)  $(-15, -8)$
- 8 When writing a geometric proof, which angle relationship could be used alone to justify that two angles are congruent?
- 1) supplementary angles
  - 2) linear pair of angles
  - 3) adjacent angles
  - 4) vertical angles

- 9 Plane  $\mathcal{R}$  is perpendicular to line  $k$  and plane  $\mathcal{D}$  is perpendicular to line  $k$ . Which statement is correct?
- 1) Plane  $\mathcal{R}$  is perpendicular to plane  $\mathcal{D}$ .
  - 2) Plane  $\mathcal{R}$  is parallel to plane  $\mathcal{D}$ .
  - 3) Plane  $\mathcal{R}$  intersects plane  $\mathcal{D}$ .
  - 4) Plane  $\mathcal{R}$  bisects plane  $\mathcal{D}$ .
- 10 The vertices of the triangle in the diagram below are  $A(7, 9)$ ,  $B(3, 3)$ , and  $C(11, 3)$ .

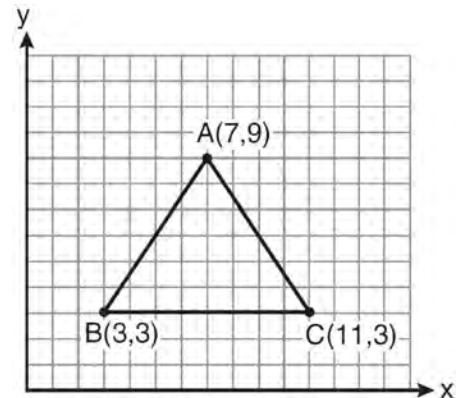

What are the coordinates of the centroid of  $\triangle ABC$ ?

- 1)  $(5, 6)$
  - 2)  $(7, 3)$
  - 3)  $(7, 5)$
  - 4)  $(9, 6)$
- 11 Which set of numbers does *not* represent the sides of a right triangle?
- 1)  $\{6, 8, 10\}$
  - 2)  $\{8, 15, 17\}$
  - 3)  $\{8, 24, 25\}$
  - 4)  $\{15, 36, 39\}$

- 12 In the diagram below of rhombus  $ABCD$ ,  $m\angle C = 100$ .

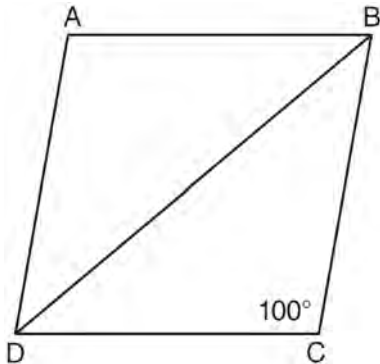

What is  $m\angle DBC$ ?

- 1) 40
  - 2) 45
  - 3) 50
  - 4) 80
- 13 In the diagram below of circle  $O$ , radius  $\overline{OC}$  is 5 cm. Chord  $\overline{AB}$  is 8 cm and is perpendicular to  $\overline{OC}$  at point  $P$ .

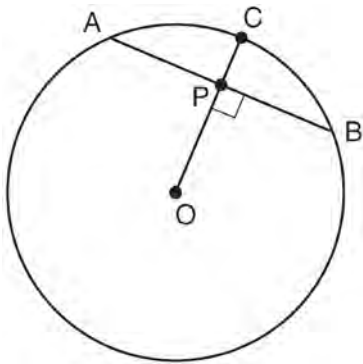

What is the length of  $\overline{OP}$ , in centimeters?

- 14 What is an equation of the line that passes through the point  $(-2, 3)$  and is parallel to the line whose equation is  $y = \frac{3}{2}x - 4$ ?

- 1)  $y = \frac{-2}{3}x$
  - 2)  $y = \frac{-2}{3}x + \frac{5}{3}$
  - 3)  $y = \frac{3}{2}x$
  - 4)  $y = \frac{3}{2}x + 6$
- 15 In scalene triangle  $ABC$ ,  $m\angle B = 45$  and  $m\angle C = 55$ . What is the order of the sides in length, from longest to shortest?
- 1)  $\overline{AB}, \overline{BC}, \overline{AC}$
  - 2)  $\overline{BC}, \overline{AC}, \overline{AB}$
  - 3)  $\overline{AC}, \overline{BC}, \overline{AB}$
  - 4)  $\overline{BC}, \overline{AB}, \overline{AC}$

- 16 What is an equation of a circle with center  $(7, -3)$  and radius 4?

- 1)  $(x - 7)^2 + (y + 3)^2 = 4$
  - 2)  $(x + 7)^2 + (y - 3)^2 = 4$
  - 3)  $(x - 7)^2 + (y + 3)^2 = 16$
  - 4)  $(x + 7)^2 + (y - 3)^2 = 16$
- 17 What is the volume, in cubic centimeters, of a cylinder that has a height of 15 cm and a diameter of 12 cm?
- 1)  $180\pi$
  - 2)  $540\pi$
  - 3)  $675\pi$
  - 4)  $2,160\pi$

- 18 Which compound statement is true?
- 1) A triangle has three sides and a quadrilateral has five sides.
  - 2) A triangle has three sides if and only if a quadrilateral has five sides.
  - 3) If a triangle has three sides, then a quadrilateral has five sides.
  - 4) A triangle has three sides or a quadrilateral has five sides.

- 19 The two lines represented by the equations below are graphed on a coordinate plane.

$$x + 6y = 12$$

$$3(x - 2) = -y - 4$$

Which statement best describes the two lines?

- 1) The lines are parallel.
- 2) The lines are the same line.
- 3) The lines are perpendicular.
- 4) The lines intersect at an angle other than  $90^\circ$ .

- 20 Which diagram shows the construction of the perpendicular bisector of  $\overline{AB}$ ?

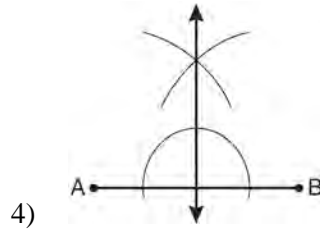
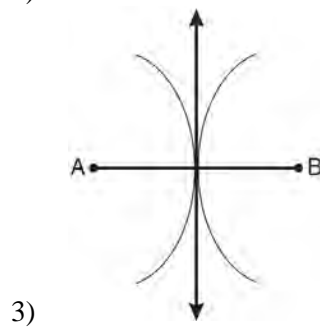
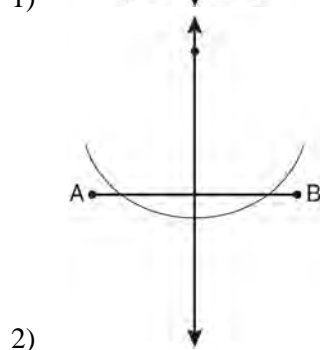
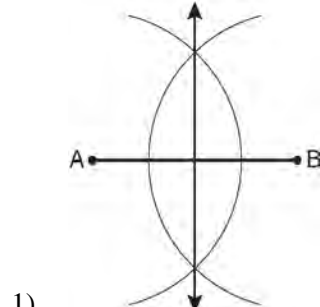

- 21 In circle  $O$ , a diameter has endpoints  $(-5, 4)$  and  $(3, -6)$ . What is the length of the diameter?

- 1)  $\sqrt{2}$
- 2)  $2\sqrt{2}$
- 3)  $\sqrt{10}$
- 4)  $2\sqrt{41}$

- 22 In the diagram of quadrilateral  $ABCD$ ,  $\overline{AB} \parallel \overline{CD}$ ,  $\angle ABC \cong \angle CDA$ , and diagonal  $\overline{AC}$  is drawn.

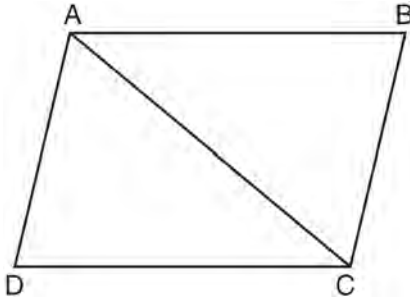

Which method can be used to prove  $\triangle ABC$  is congruent to  $\triangle CDA$ ?

- 1) AAS
  - 2) SSA
  - 3) SAS
  - 4) SSS
- 23 In the diagram below of right triangle  $ABC$ ,  $\overline{CD}$  is the altitude to hypotenuse  $\overline{AB}$ ,  $CB = 6$ , and  $AD = 5$ .

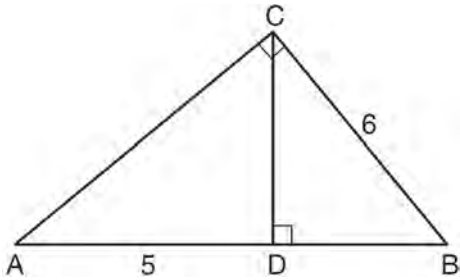

What is the length of  $\overline{BD}$ ?

- 1) 5
- 2) 9
- 3) 3
- 4) 4

- 24 In the diagram below, quadrilateral  $JUMP$  is inscribed in a circle..

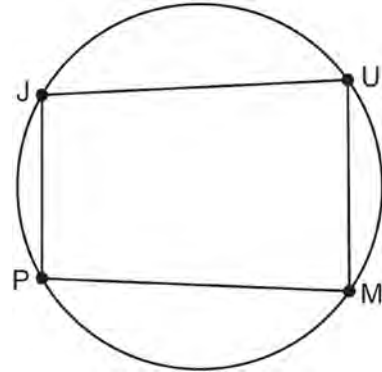

Opposite angles  $J$  and  $M$  must be

- 1) right
- 2) complementary
- 3) congruent
- 4) supplementary

- 25 Which graph represents a circle with the equation  $(x - 3)^2 + (y + 1)^2 = 4$ ?

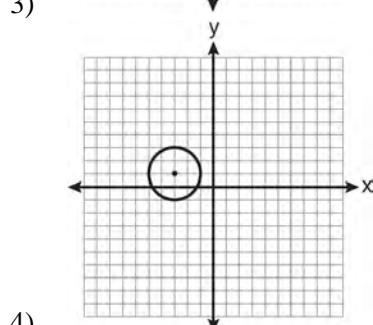
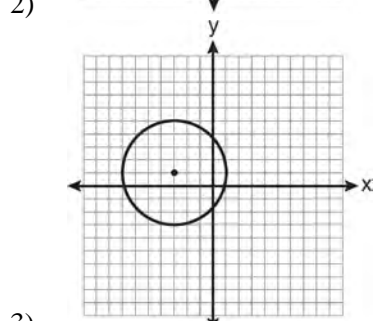
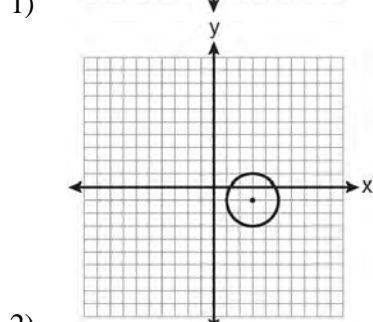
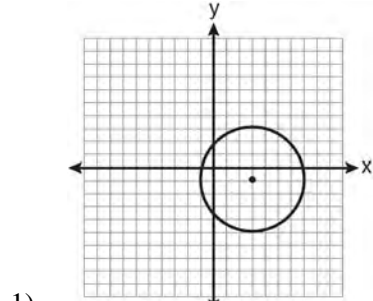

- 26 The point  $(3, -2)$  is rotated  $90^\circ$  about the origin and then dilated by a scale factor of 4. What are the coordinates of the resulting image?
- 1)  $(-12, 8)$
  - 2)  $(12, -8)$
  - 3)  $(8, 12)$
  - 4)  $(-8, -12)$

- 27 In the diagram below of  $\triangle ABC$ , side  $\overline{BC}$  is extended to point  $D$ ,  $m\angle A = x$ ,  $m\angle B = 2x + 15$ , and  $m\angle ACD = 5x + 5$ .

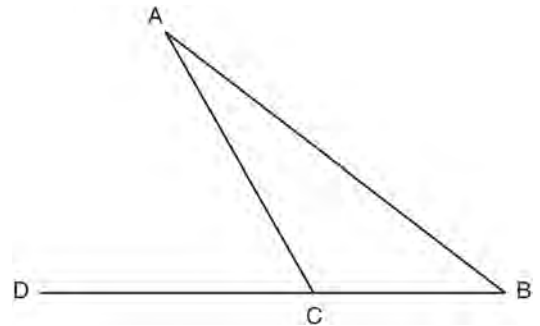

What is  $m\angle B$ ?

- 1) 5
  - 2) 20
  - 3) 25
  - 4) 55
- 28 Point  $P$  lies on line  $m$ . Point  $P$  is also included in distinct planes  $Q$ ,  $R$ ,  $S$ , and  $T$ . At most, how many of these planes could be perpendicular to line  $m$ ?
- 1) 1
  - 2) 2
  - 3) 3
  - 4) 4

- 29 In the diagram below of  $\triangle ACD$ ,  $B$  is a point on  $\overline{AC}$  such that  $\triangle ADB$  is an equilateral triangle, and  $\triangle DBC$  is an isosceles triangle with  $DB \cong BC$ . Find  $m\angle C$ .

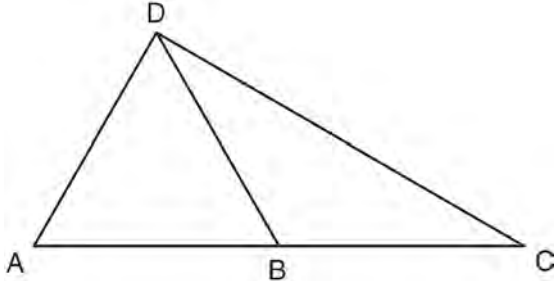

- 30 Triangle  $ABC$  has vertices  $A(-2,2)$ ,  $B(-1,-3)$ , and  $C(4,0)$ . Find the coordinates of the vertices of  $\triangle A'B'C'$ , the image of  $\triangle ABC$  after the transformation  $r_{x\text{-axis}}$ . [The use of the grid is optional.]

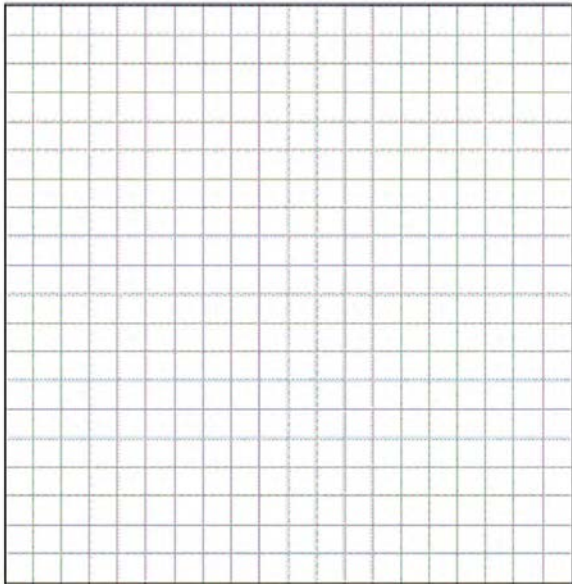

- 31 Find, in degrees, the measures of both an interior angle and an exterior angle of a regular pentagon.

- 32 In the diagram below of circle  $O$ , chord  $\overline{AB}$  bisects chord  $\overline{CD}$  at  $E$ . If  $AE = 8$  and  $BE = 9$ , find the length of  $\overline{CE}$  in simplest radical form.

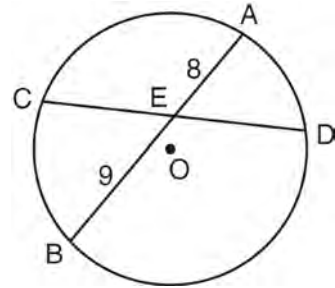

- 33 On the diagram below, use a compass and straightedge to construct the bisector of  $\angle ABC$ . [Leave all construction marks.]

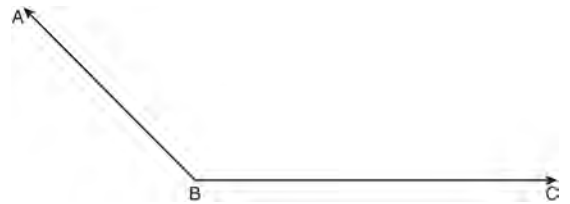

- 34 Find the slope of a line perpendicular to the line whose equation is  $2y - 6x = 4$ .

- 35 On the set of axes below, graph the locus of points that are four units from the point  $(2, 1)$ . On the same set of axes, graph the locus of points that are two units from the line  $x = 4$ . State the coordinates of all points that satisfy both conditions.

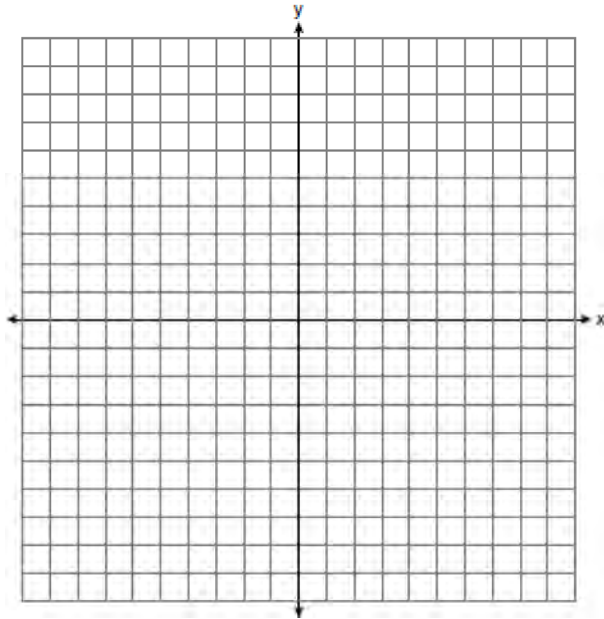

- 36 In the diagram below,  $\overline{BFCE}$ ,  $\overline{AB} \perp \overline{BE}$ ,  $\overline{DE} \perp \overline{BE}$ , and  $\angle BFD \cong \angle ECA$ . Prove that  $\triangle ABC \sim \triangle DEF$ .

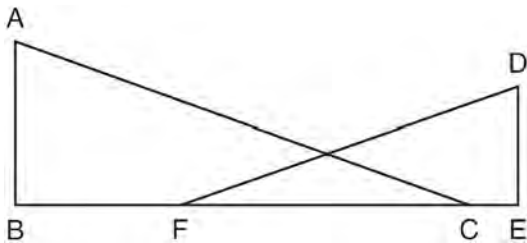

- 37 In the diagram below of  $\triangle ADE$ ,  $B$  is a point on  $\overline{AE}$  and  $C$  is a point on  $\overline{AD}$  such that  $\overline{BC} \parallel \overline{ED}$ ,  $AC = x - 3$ ,  $BE = 20$ ,  $AB = 16$ , and  $AD = 2x + 2$ . Find the length of  $\overline{AC}$ .

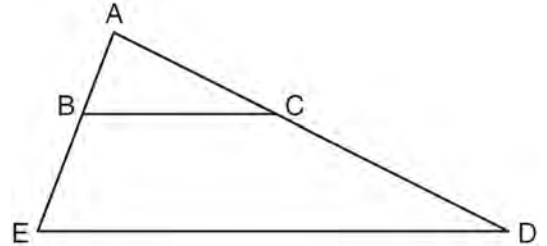

- 38 Quadrilateral  $MATH$  has coordinates  $M(1, 1)$ ,  $A(-2, 5)$ ,  $T(3, 5)$ , and  $H(6, 1)$ . Prove that quadrilateral  $MATH$  is a rhombus and prove that it is *not* a square. [The use of the grid is optional.]

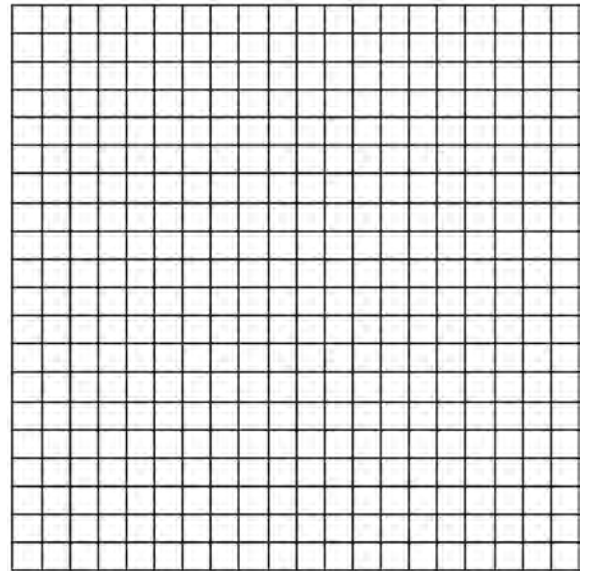



**0611ge**

- 1 Line segment  $AB$  is shown in the diagram below.

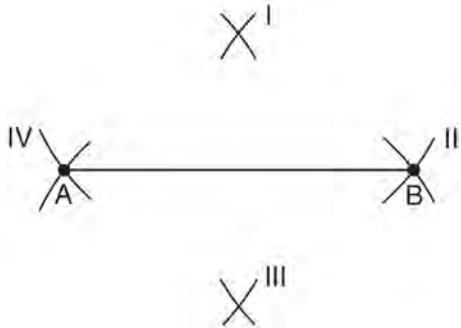

Which two sets of construction marks, labeled I, II, III, and IV, are part of the construction of the perpendicular bisector of line segment  $AB$ ?

- 1) I and II
  - 2) I and III
  - 3) II and III
  - 4) II and IV
- 2 If  $\triangle JKL \cong \triangle MNO$ , which statement is always true?
- 1)  $\angle K LJ \cong \angle NMO$
  - 2)  $\angle K JL \cong \angle M ON$
  - 3)  $\overline{JL} \cong \overline{MO}$
  - 4)  $\overline{JK} \cong \overline{ON}$

- 3 In the diagram below,  $\triangle A'B'C'$  is a transformation of  $\triangle ABC$ , and  $\triangle A''B''C''$  is a transformation of  $\triangle A'B'C'$ .

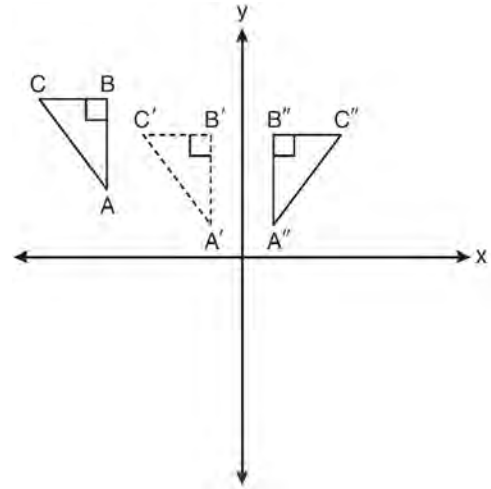

The composite transformation of  $\triangle ABC$  to  $\triangle A''B''C''$  is an example of a

- 1) reflection followed by a rotation
- 2) reflection followed by a translation
- 3) translation followed by a rotation
- 4) translation followed by a reflection

- 4 In the diagram below of  $\triangle ACE$ , medians  $\overline{AD}$ ,  $\overline{EB}$ , and  $\overline{CF}$  intersect at  $G$ . The length of  $\overline{FG}$  is 12 cm.

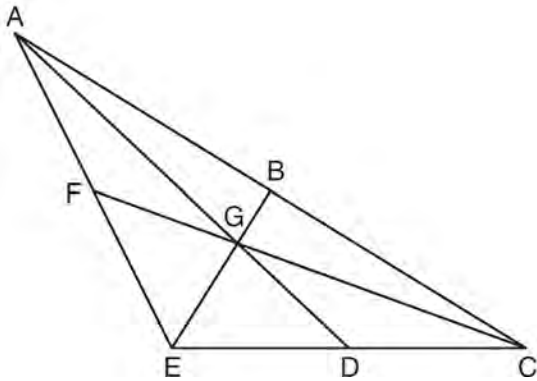

What is the length, in centimeters, of  $\overline{GC}$ ?

- 1) 24
  - 2) 12
  - 3) 6
  - 4) 4
- 5 In the diagram below of circle  $O$ , chord  $\overline{AB}$  is parallel to chord  $\overline{CD}$ .

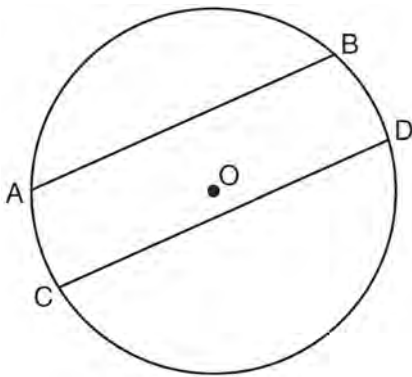

Which statement must be true?

- 1)  $\widehat{AC} \cong \widehat{BD}$
- 2)  $\widehat{AB} \cong \widehat{CD}$
- 3)  $\overline{AB} \cong \overline{CD}$
- 4)  $\widehat{ABD} \cong \widehat{CDB}$

- 6 In the diagram below, line  $p$  intersects line  $m$  and line  $n$ .

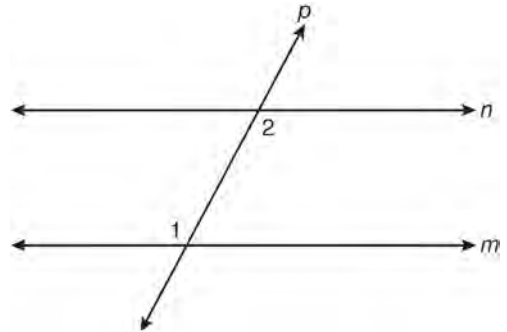

If  $m\angle 1 = 7x$  and  $m\angle 2 = 5x + 30$ , lines  $m$  and  $n$  are parallel when  $x$  equals

- 1) 12.5
  - 2) 15
  - 3) 87.5
  - 4) 105
- 7 In the diagram of  $\triangle KLM$  below,  $m\angle L = 70$ ,  $m\angle M = 50$ , and  $\overline{MK}$  is extended through  $N$ .

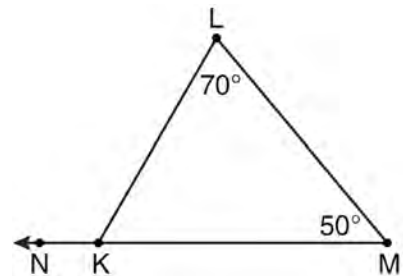

What is the measure of  $\angle LKN$ ?

- 1)  $60^\circ$
- 2)  $120^\circ$
- 3)  $180^\circ$
- 4)  $300^\circ$

8 If two distinct planes,  $\mathcal{A}$  and  $\mathcal{B}$ , are perpendicular to line  $c$ , then which statement is true?

- 1) Planes  $\mathcal{A}$  and  $\mathcal{B}$  are parallel to each other.
- 2) Planes  $\mathcal{A}$  and  $\mathcal{B}$  are perpendicular to each other.
- 3) The intersection of planes  $\mathcal{A}$  and  $\mathcal{B}$  is a line parallel to line  $c$ .
- 4) The intersection of planes  $\mathcal{A}$  and  $\mathcal{B}$  is a line perpendicular to line  $c$ .

9 What is the length of the line segment whose endpoints are  $A(-1,9)$  and  $B(7,4)$ ?

- 1)  $\sqrt{61}$
- 2)  $\sqrt{89}$
- 3)  $\sqrt{205}$
- 4)  $\sqrt{233}$

10 What is an equation of circle  $O$  shown in the graph below?

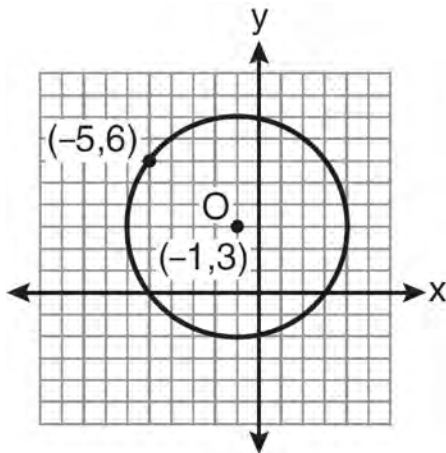

- 1)  $(x + 1)^2 + (y - 3)^2 = 25$
- 2)  $(x - 1)^2 + (y + 3)^2 = 25$
- 3)  $(x - 5)^2 + (y + 6)^2 = 25$
- 4)  $(x + 5)^2 + (y - 6)^2 = 25$

11 In the diagram below, parallelogram  $ABCD$  has diagonals  $\overline{AC}$  and  $\overline{BD}$  that intersect at point  $E$ .

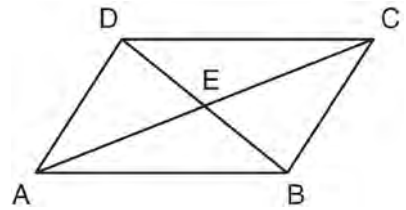

Which expression is *not* always true?

- 1)  $\angle DAE \cong \angle BCE$
- 2)  $\angle DEC \cong \angle BEA$
- 3)  $\overline{AC} \cong \overline{DB}$
- 4)  $\overline{DE} \cong \overline{EB}$

12 The volume, in cubic centimeters, of a sphere whose diameter is 6 centimeters is

- 1)  $12\pi$
- 2)  $36\pi$
- 3)  $48\pi$
- 4)  $288\pi$

13 The equation of line  $k$  is  $y = \frac{1}{3}x - 2$ . The equation of line  $m$  is  $-2x + 6y = 18$ . Lines  $k$  and  $m$  are

- 1) parallel
- 2) perpendicular
- 3) the same line
- 4) neither parallel nor perpendicular

14 What are the center and the radius of the circle whose equation is  $(x - 5)^2 + (y + 3)^2 = 16$ ?

- 1)  $(-5, 3)$  and 16
- 2)  $(5, -3)$  and 16
- 3)  $(-5, 3)$  and 4
- 4)  $(5, -3)$  and 4

15 Triangle  $ABC$  has vertices  $A(0,0)$ ,  $B(3,2)$ , and  $C(0,4)$ . The triangle may be classified as

- 1) equilateral
- 2) isosceles
- 3) right
- 4) scalene

- 16 In rhombus  $ABCD$ , the diagonals  $\overline{AC}$  and  $\overline{BD}$  intersect at  $E$ . If  $AE = 5$  and  $BE = 12$ , what is the length of  $\overline{AB}$ ?
- 1) 7
  - 2) 10
  - 3) 13
  - 4) 17

- 17 In the diagram below of circle  $O$ ,  $\overline{PA}$  is tangent to circle  $O$  at  $A$ , and  $\overline{PBC}$  is a secant with points  $B$  and  $C$  on the circle.

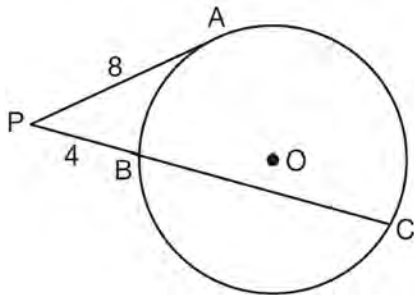

If  $PA = 8$  and  $PB = 4$ , what is the length of  $\overline{BC}$ ?

- 1) 20
  - 2) 16
  - 3) 15
  - 4) 12
- 18 Lines  $m$  and  $n$  intersect at point  $A$ . Line  $k$  is perpendicular to both lines  $m$  and  $n$  at point  $A$ . Which statement *must* be true?
- 1) Lines  $m$ ,  $n$ , and  $k$  are in the same plane.
  - 2) Lines  $m$  and  $n$  are in two different planes.
  - 3) Lines  $m$  and  $n$  are perpendicular to each other.
  - 4) Line  $k$  is perpendicular to the plane containing lines  $m$  and  $n$ .
- 19 In  $\triangle DEF$ ,  $m\angle D = 3x + 5$ ,  $m\angle E = 4x - 15$ , and  $m\angle F = 2x + 10$ . Which statement is true?
- 1)  $DF = FE$
  - 2)  $DE = FE$
  - 3)  $m\angle E = m\angle F$
  - 4)  $m\angle D = m\angle F$

- 20 As shown in the diagram below,  $\triangle ABC \sim \triangle DEF$ ,  $AB = 7x$ ,  $BC = 4$ ,  $DE = 7$ , and  $EF = x$ .

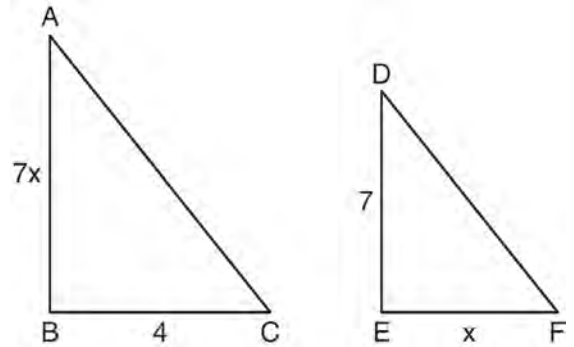

What is the length of  $\overline{AB}$ ?

- 1) 28
  - 2) 2
  - 3) 14
  - 4) 4
- 21 A man wants to place a new bird bath in his yard so that it is 30 feet from a fence,  $f$ , and also 10 feet from a light pole,  $P$ . As shown in the diagram below, the light pole is 35 feet away from the fence.

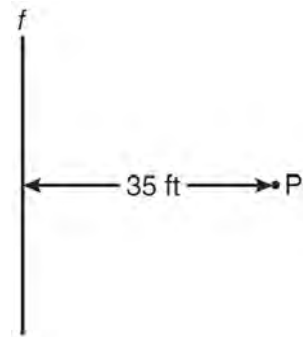

How many locations are possible for the bird bath?

- 1) 1
- 2) 2
- 3) 3
- 4) 0

- 22 As shown on the graph below,  $\triangle R'S'T'$  is the image of  $\triangle RST$  under a single transformation.

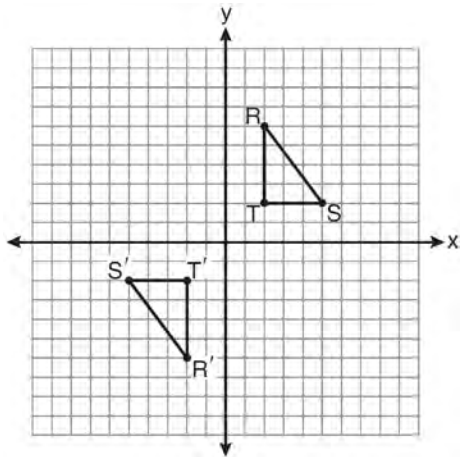

Which transformation does this graph represent?

- 1) glide reflection
  - 2) line reflection
  - 3) rotation
  - 4) translation
- 23 Which line is parallel to the line whose equation is  $4x + 3y = 7$  and also passes through the point  $(-5, 2)$ ?
- 1)  $4x + 3y = -26$
  - 2)  $4x + 3y = -14$
  - 3)  $3x + 4y = -7$
  - 4)  $3x + 4y = 14$
- 24 If the vertex angles of two isosceles triangles are congruent, then the triangles must be
- 1) acute
  - 2) congruent
  - 3) right
  - 4) similar
- 25 Which quadrilateral has diagonals that always bisect its angles and also bisect each other?
- 1) rhombus
  - 2) rectangle
  - 3) parallelogram
  - 4) isosceles trapezoid

- 26 When  $\triangle ABC$  is dilated by a scale factor of 2, its image is  $\triangle A'B'C'$ . Which statement is true?
- 1)  $\overline{AC} \cong \overline{A'C'}$
  - 2)  $\angle A \cong \angle A'$
  - 3) perimeter of  $\triangle ABC =$  perimeter of  $\triangle A'B'C'$
  - 4)  $2(\text{area of } \triangle ABC) = \text{area of } \triangle A'B'C'$

- 27 What is the slope of a line that is perpendicular to the line whose equation is  $3x + 5y = 4$ ?
- 1)  $-\frac{3}{5}$
  - 2)  $\frac{3}{5}$
  - 3)  $-\frac{5}{3}$
  - 4)  $\frac{5}{3}$

- 28 In the diagram below of right triangle  $ABC$ , altitude  $\overline{BD}$  is drawn to hypotenuse  $\overline{AC}$ ,  $AC = 16$ , and  $CD = 7$ .

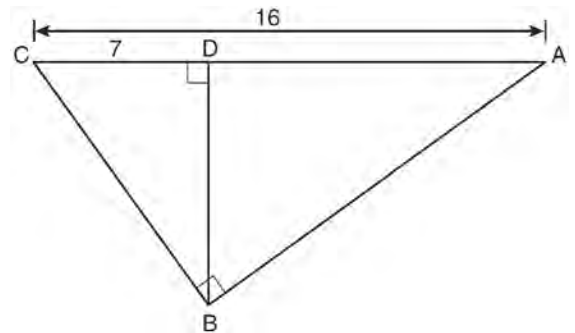

What is the length of  $\overline{BD}$ ?

- 1)  $3\sqrt{7}$
  - 2)  $4\sqrt{7}$
  - 3)  $7\sqrt{3}$
  - 4) 12
- 29 Given the true statement, "The medians of a triangle are concurrent," write the negation of the statement and give the truth value for the negation.

- 30 Using a compass and straightedge, on the diagram below of  $\overleftrightarrow{RS}$ , construct an equilateral triangle with  $\overline{RS}$  as one side. [Leave all construction marks.]



- 31 The Parkside Packing Company needs a rectangular shipping box. The box must have a length of 11 inches and a width of 8 inches. Find, to the nearest tenth of an inch, the minimum height of the box such that the volume is at least 800 cubic inches.

- 32 A pentagon is drawn on the set of axes below. If the pentagon is reflected over the  $y$ -axis, determine if this transformation is an isometry. Justify your answer. [The use of the set of axes is optional.]

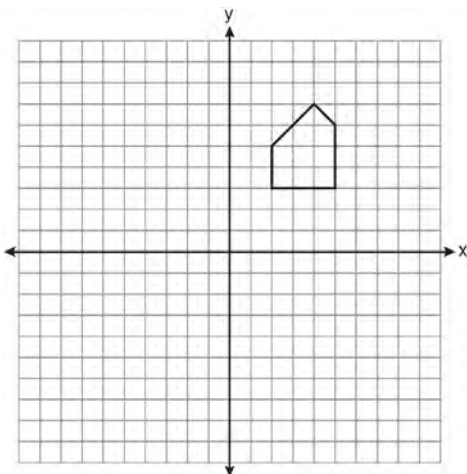

- 33 In the diagram below of  $\triangle ABC$ ,  $D$  is a point on  $\overline{AB}$ ,  $E$  is a point on  $\overline{BC}$ ,  $\overline{AC} \parallel \overline{DE}$ ,  $CE = 25$  inches,  $AD = 18$  inches, and  $DB = 12$  inches. Find, to the nearest tenth of an inch, the length of  $\overline{EB}$ .

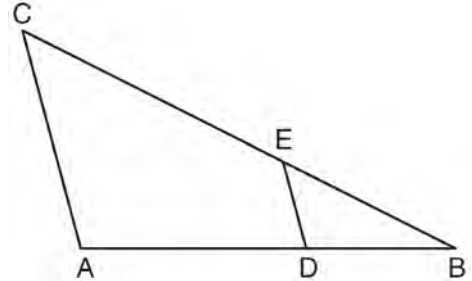

- 34 In circle  $O$ , diameter  $\overline{RS}$  has endpoints  $R(3a, 2b - 1)$  and  $S(a - 6, 4b + 5)$ . Find the coordinates of point  $O$ , in terms of  $a$  and  $b$ . Express your answer in simplest form.
- 35 On the set of coordinate axes below, graph the locus of points that are equidistant from the lines  $y = 6$  and  $y = 2$  and also graph the locus of points that are 3 units from the  $y$ -axis. State the coordinates of all points that satisfy both conditions.

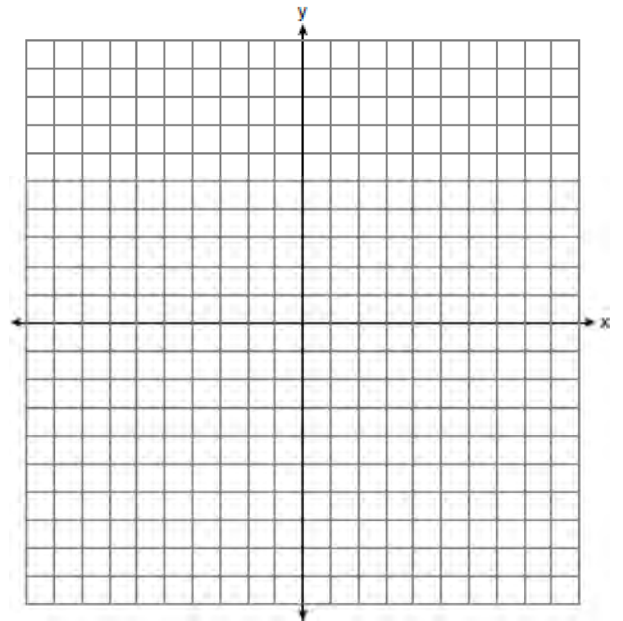

- 36 In the diagram below, tangent  $\overline{ML}$  and secant  $\overline{MKN}$  are drawn to circle  $O$ . The ratio  $m\widehat{LN} : m\widehat{NK} : m\widehat{KL}$  is 3:4:5. Find  $m\angle LMK$ .

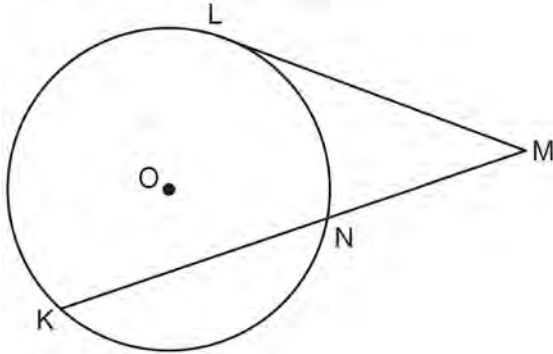

- 38 In the diagram below,  $\overline{PA}$  and  $\overline{PB}$  are tangent to circle  $O$ ,  $\overline{OA}$  and  $\overline{OB}$  are radii, and  $\overline{OP}$  intersects the circle at  $C$ . Prove:  $\angle AOP \cong \angle BOP$

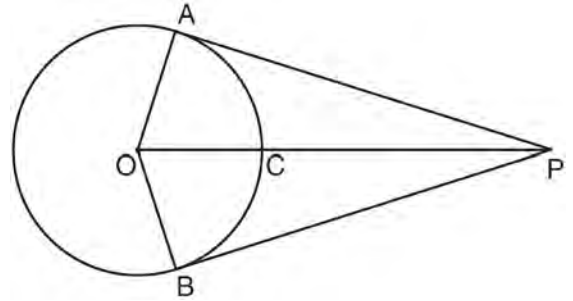

- 37 Solve the following system of equations graphically.

$$2x^2 - 4x = y + 1$$

$$x + y = 1$$

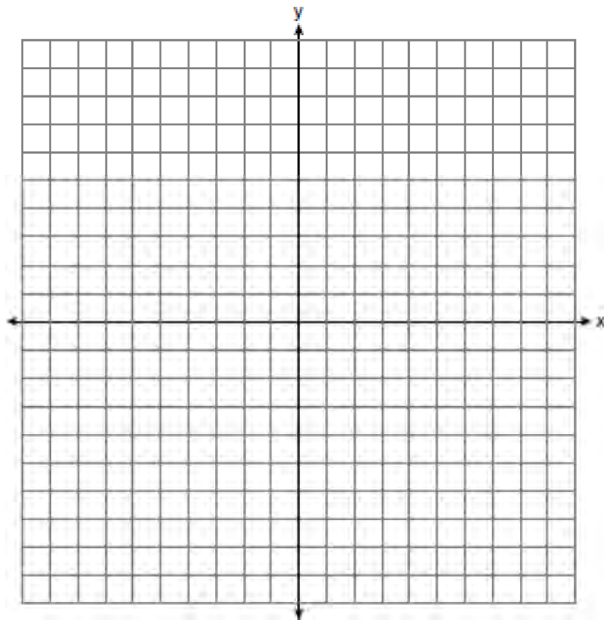

0811ge

- 1 The statement "x is a multiple of 3, and x is an even integer" is true when x is equal to

- 1) 9
- 2) 8
- 3) 3
- 4) 6

- 2 In the diagram below,  $\triangle ABC \cong \triangle XYZ$ .

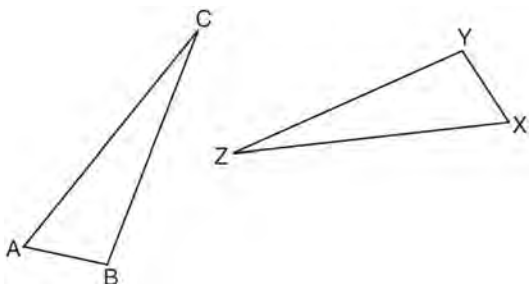

Which statement must be true?

- 1)  $\angle C \cong \angle Y$
- 2)  $\angle A \cong \angle X$
- 3)  $\overline{AC} \cong \overline{YZ}$
- 4)  $\overline{CB} \cong \overline{XZ}$

- 3 In the diagram below of  $\triangle ABC$ ,  $\overleftrightarrow{TV} \parallel \overline{BC}$ ,  $AT = 5$ ,  $TB = 7$ , and  $AV = 10$ .

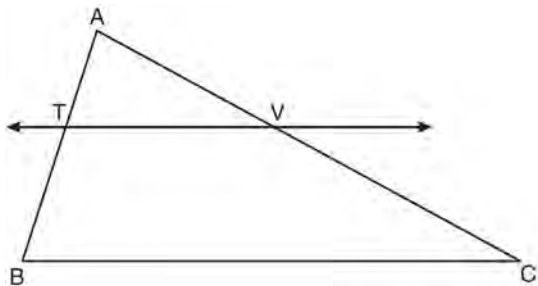

What is the length of  $\overline{VC}$ ?

- 1)  $3\frac{1}{2}$
- 2)  $7\frac{1}{7}$
- 3) 14
- 4) 24

- 4 Pentagon  $PQRST$  has  $\overline{PQ}$  parallel to  $\overline{TS}$ . After a translation of  $T_{2,-5}$ , which line segment is parallel to  $\overline{P'Q'}$ ?

- 1)  $\overline{R'Q'}$
- 2)  $\overline{R'S'}$
- 3)  $\overline{T'S'}$
- 4)  $\overline{T'P'}$

- 5 In the diagram below of  $\triangle PAO$ ,  $\overline{AP}$  is tangent to circle  $O$  at point  $A$ ,  $OB = 7$ , and  $BP = 18$ .

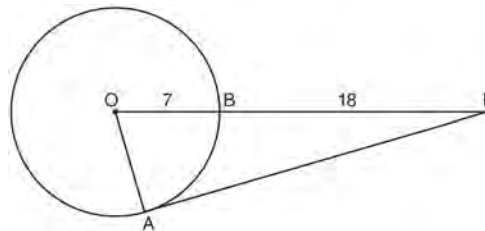

What is the length of  $\overline{AP}$ ?

- 1) 10
- 2) 12
- 3) 17
- 4) 24



- 6 .A straightedge and compass were used to create the construction below. Arc  $EF$  was drawn from point  $B$ , and arcs with equal radii were drawn from  $E$  and  $F$ .

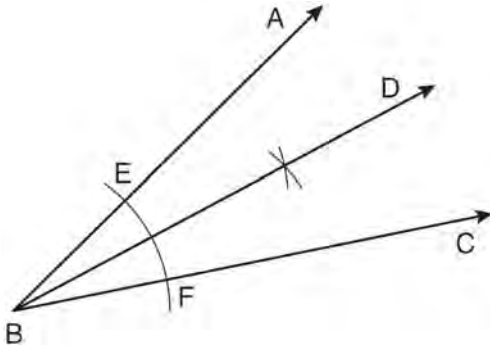

Which statement is *false*?

- 1)  $m\angle ABD = m\angle DBC$
  - 2)  $\frac{1}{2}(m\angle ABC) = m\angle ABD$
  - 3)  $2(m\angle DBC) = m\angle ABC$
  - 4)  $2(m\angle ABC) = m\angle CBD$
- 7 What is the length of the line segment whose endpoints are  $(1, -4)$  and  $(9, 2)$ ?
- 1) 5
  - 2)  $2\sqrt{17}$
  - 3) 10
  - 4)  $2\sqrt{26}$
- 8 What is the image of the point  $(2, -3)$  after the transformation  $r_{y\text{-axis}}$ ?
- 1)  $(2, 3)$
  - 2)  $(-2, -3)$
  - 3)  $(-2, 3)$
  - 4)  $(-3, 2)$

- 9 In the diagram below, lines  $n$  and  $m$  are cut by transversals  $p$  and  $q$ .

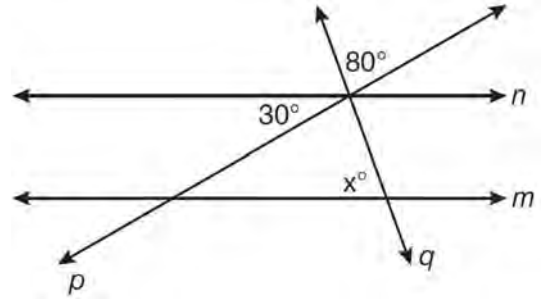

What value of  $x$  would make lines  $n$  and  $m$  parallel?

- 1) 110
  - 2) 80
  - 3) 70
  - 4) 50
- 10 What is an equation of the circle with a radius of 5 and center at  $(1, -4)$ ?
- 1)  $(x + 1)^2 + (y - 4)^2 = 5$
  - 2)  $(x - 1)^2 + (y + 4)^2 = 5$
  - 3)  $(x + 1)^2 + (y - 4)^2 = 25$
  - 4)  $(x - 1)^2 + (y + 4)^2 = 25$
- 11 In the diagram below of  $\triangle BCD$ , side  $\overline{DB}$  is extended to point  $A$ .

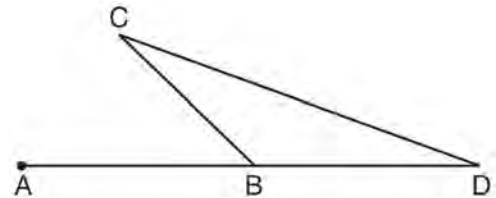

Which statement must be true?

- 1)  $m\angle C > m\angle D$
- 2)  $m\angle ABC < m\angle D$
- 3)  $m\angle ABC > m\angle C$
- 4)  $m\angle ABC > m\angle C + m\angle D$

- 12 Which equation represents the line parallel to the line whose equation is  $4x + 2y = 14$  and passing through the point  $(2, 2)$ ?

- 1)  $y = -2x$
- 2)  $y = -2x + 6$
- 3)  $y = \frac{1}{2}x$
- 4)  $y = \frac{1}{2}x + 1$

- 13 The coordinates of point  $A$  are  $(-3a, 4b)$ . If point  $A'$  is the image of point  $A$  reflected over the line  $y = x$ , the coordinates of  $A'$  are

- 1)  $(4b, -3a)$
- 2)  $(3a, 4b)$
- 3)  $(-3a, -4b)$
- 4)  $(-4b, -3a)$

- 14 As shown in the diagram below,  $\overline{AC}$  bisects  $\angle BAD$  and  $\angle B \cong \angle D$ .

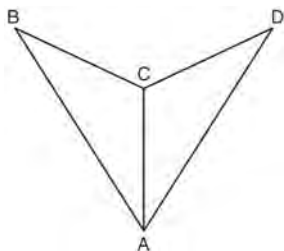

Which method could be used to prove  $\triangle ABC \cong \triangle ADC$ ?

- 1) SSS
- 2) AAA
- 3) SAS
- 4) AAS

- 15 Segment  $AB$  is the diameter of circle  $M$ . The coordinates of  $A$  are  $(-4, 3)$ . The coordinates of  $M$  are  $(1, 5)$ . What are the coordinates of  $B$ ?

- 1)  $(6, 7)$
- 2)  $(5, 8)$
- 3)  $(-3, 8)$
- 4)  $(-5, 2)$

- 16 In the diagram below,  $\overleftrightarrow{AB}$  is perpendicular to plane  $AEFG$ .

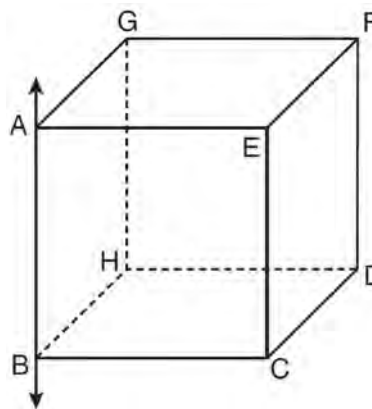

Which plane must be perpendicular to plane  $AEFG$ ?

- 1)  $ABCE$
- 2)  $BCDH$
- 3)  $CDFE$
- 4)  $HDFG$

- 17 How many points are both 4 units from the origin and also 2 units from the line  $y = 4$ ?

- 1) 1
- 2) 2
- 3) 3
- 4) 4

- 18 When solved graphically, what is the solution to the following system of equations?

$$y = x^2 - 4x + 6$$

$$y = x + 2$$

- 1)  $(1, 4)$
- 2)  $(4, 6)$
- 3)  $(1, 3)$  and  $(4, 6)$
- 4)  $(3, 1)$  and  $(6, 4)$

- 19 Triangle  $PQR$  has angles in the ratio of  $2:3:5$ . Which type of triangle is  $\triangle PQR$ ?

- 1) acute
- 2) isosceles
- 3) obtuse
- 4) right

20 Plane  $\mathcal{A}$  is parallel to plane  $\mathcal{B}$ . Plane  $\mathcal{C}$  intersects plane  $\mathcal{A}$  in line  $m$  and intersects plane  $\mathcal{B}$  in line  $n$ .

Lines  $m$  and  $n$  are

- 1) intersecting
- 2) parallel
- 3) perpendicular
- 4) skew

21 The diagonals of a quadrilateral are congruent but do not bisect each other. This quadrilateral is

- 1) an isosceles trapezoid
- 2) a parallelogram
- 3) a rectangle
- 4) a rhombus

22 What is the slope of a line that is perpendicular to the line represented by the equation  $x + 2y = 3$ ?

- 1)  $-2$
- 2)  $2$
- 3)  $-\frac{1}{2}$
- 4)  $\frac{1}{2}$

23 A packing carton in the shape of a triangular prism is shown in the diagram below.

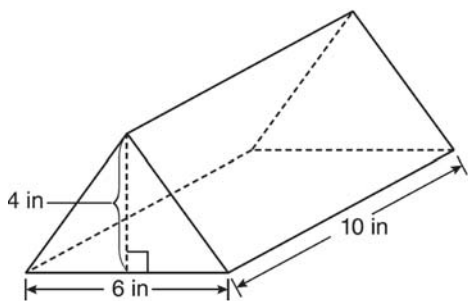

What is the volume, in cubic inches, of this carton?

- 1) 20
- 2) 60
- 3) 120
- 4) 240

24 In the diagram below of circle  $O$ , diameter  $\overline{AOB}$  is perpendicular to chord  $\overline{CD}$  at point  $E$ ,  $OA = 6$ , and  $OE = 2$ .

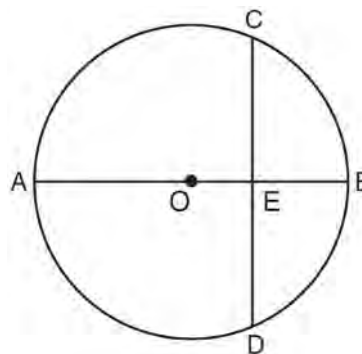

What is the length of  $\overline{CE}$ ?

- 1)  $4\sqrt{3}$
- 2)  $2\sqrt{3}$
- 3)  $8\sqrt{2}$
- 4)  $4\sqrt{2}$

25 What is the measure of each interior angle of a regular hexagon?

- 1)  $60^\circ$
- 2)  $120^\circ$
- 3)  $135^\circ$
- 4)  $270^\circ$

26 Which equation represents the perpendicular bisector of  $\overline{AB}$  whose endpoints are  $A(8, 2)$  and  $B(0, 6)$ ?

- 1)  $y = 2x - 4$
- 2)  $y = -\frac{1}{2}x + 2$
- 3)  $y = -\frac{1}{2}x + 6$
- 4)  $y = 2x - 12$

- 27 As shown in the diagram below, a kite needs a vertical and a horizontal support bar attached at opposite corners. The upper edges of the kite are 7 inches, the side edges are  $x$  inches, and the vertical support bar is  $(x + 1)$  inches.

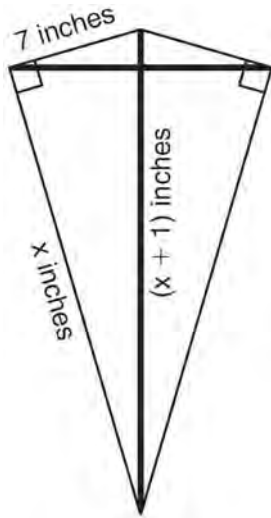

What is the measure, in inches, of the vertical support bar?

- 1) 23
  - 2) 24
  - 3) 25
  - 4) 26
- 28 Given three distinct quadrilaterals, a square, a rectangle, and a rhombus, which quadrilaterals must have perpendicular diagonals?
- 1) the rhombus, only
  - 2) the rectangle and the square
  - 3) the rhombus and the square
  - 4) the rectangle, the rhombus, and the square

- 29 In the diagram below, trapezoid  $ABCD$ , with bases  $\overline{AB}$  and  $\overline{DC}$ , is inscribed in circle  $O$ , with diameter  $\overline{DC}$ . If  $m\widehat{AB}=80$ , find  $m\widehat{BC}$ .

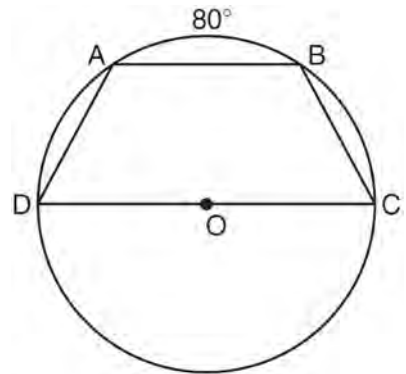

- 30 On the diagram of  $\triangle ABC$  shown below, use a compass and straightedge to construct the perpendicular bisector of  $\overline{AC}$ . [Leave all construction marks.]

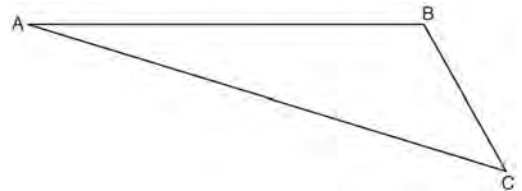

- 31 A sphere has a diameter of 18 meters. Find the volume of the sphere, in cubic meters, in terms of  $\pi$ .

- 32 Write an equation of the circle graphed in the diagram below.

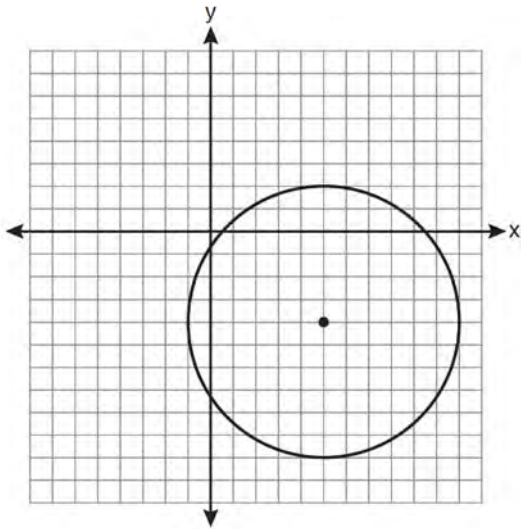

- 33 The diagram below shows  $\triangle ABC$ , with  $\overline{AEB}$ ,  $\overline{ADC}$ , and  $\angle ACB \cong \angle AED$ . Prove that  $\triangle ABC$  is similar to  $\triangle ADE$ .

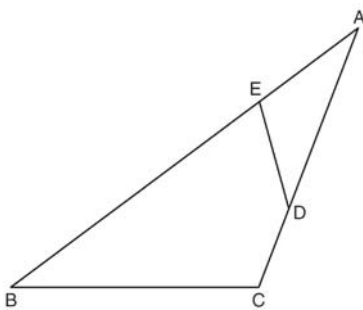

- 34 Triangle  $ABC$  has vertices  $A(3, 3)$ ,  $B(7, 9)$ , and  $C(11, 3)$ . Determine the point of intersection of the medians, and state its coordinates. [The use of the set of axes below is optional.]

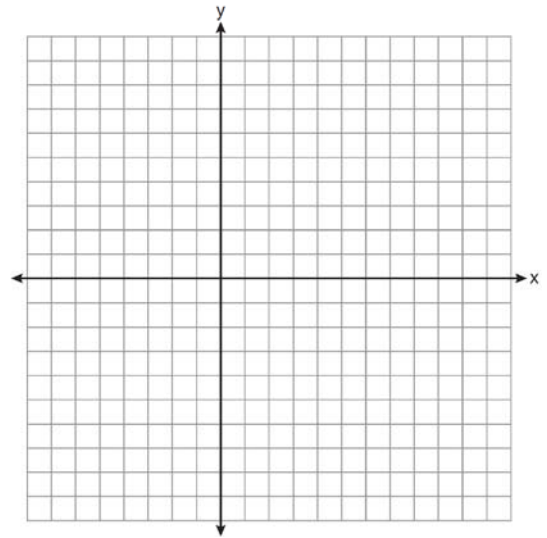

- 35 In the diagram below of  $\triangle GJK$ ,  $H$  is a point on  $\overline{GJ}$ ,  $\overline{HJ} \cong \overline{JK}$ ,  $m\angle G = 28$ , and  $m\angle GJK = 70$ . Determine whether  $\triangle GHK$  is an isosceles triangle and justify your answer.

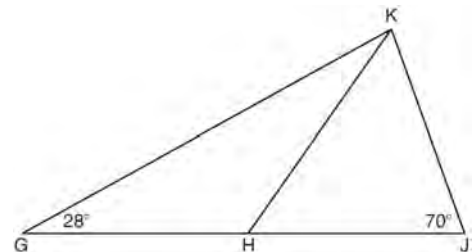

- 36 As shown on the set of axes below,  $\triangle GHS$  has vertices  $G(3, 1)$ ,  $H(5, 3)$ , and  $S(1, 4)$ . Graph and state the coordinates of  $\triangle G''H''S''$ , the image of  $\triangle GHS$  after the transformation  $T_{-3,1} \circ D_2$ .

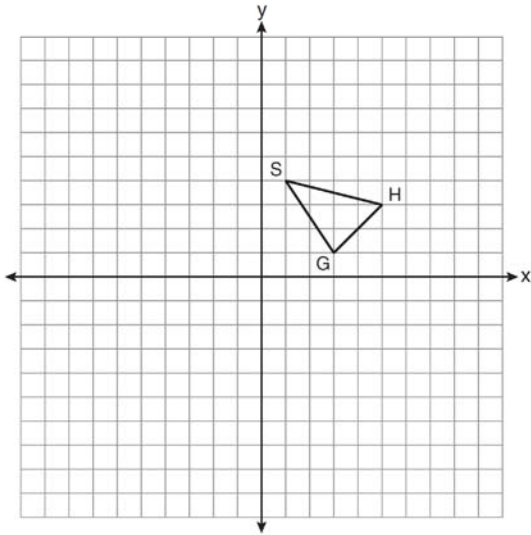

- 38 Given:  $\triangle ABC$  with vertices  $A(-6, -2)$ ,  $B(2, 8)$ , and  $C(6, -2)$ .  $\overline{AB}$  has midpoint  $D$ ,  $\overline{BC}$  has midpoint  $E$ , and  $\overline{AC}$  has midpoint  $F$ .

Prove:  $ADEF$  is a parallelogram

$ADEF$  is *not* a rhombus

[The use of the grid is optional.]

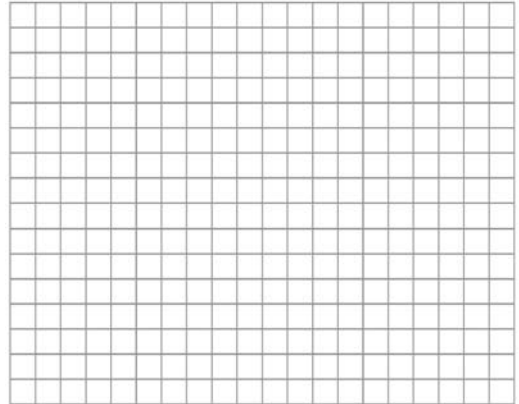

- 37 In the diagram below,  $\triangle ABC \sim \triangle DEF$ ,  $DE = 4$ ,  $AB = x$ ,  $AC = x + 2$ , and  $DF = x + 6$ . Determine the length of  $AB$ . [Only an algebraic solution can receive full credit.]

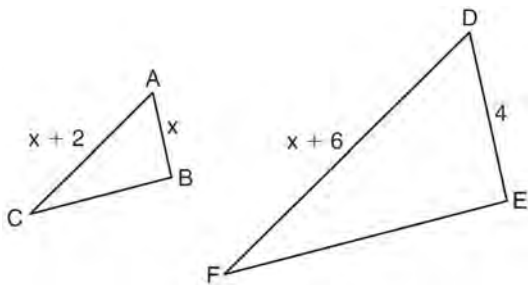

**0112ge**

- 1 Line  $n$  intersects lines  $l$  and  $m$ , forming the angles shown in the diagram below.

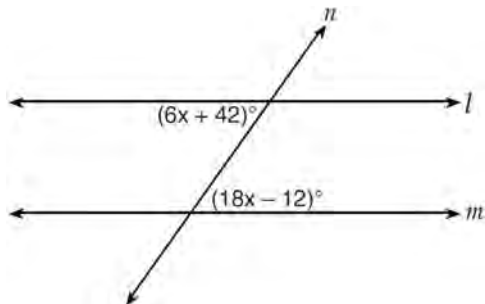

Which value of  $x$  would prove  $l \parallel m$ ?

- 1) 2.5
  - 2) 4.5
  - 3) 6.25
  - 4) 8.75
- 2 In a given triangle, the point of intersection of the three medians is the same as the point of intersection of the three altitudes. Which classification of the triangle is correct?
- 1) scalene triangle
  - 2) isosceles triangle
  - 3) equilateral triangle
  - 4) right isosceles triangle
- 3 A circle has the equation  $(x - 2)^2 + (y + 3)^2 = 36$ . What are the coordinates of its center and the length of its radius?
- 1)  $(-2, 3)$  and 6
  - 2)  $(2, -3)$  and 6
  - 3)  $(-2, 3)$  and 36
  - 4)  $(2, -3)$  and 36

- 4 In the diagram below,  $MATH$  is a rhombus with diagonals  $AH$  and  $MT$ .

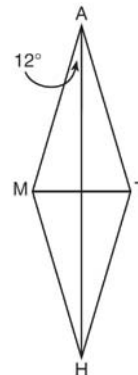

If  $m\angle HAM = 12$ , what is  $m\angle AMT$ ?

- 1) 12
  - 2) 78
  - 3) 84
  - 4) 156
- 5 A line segment has endpoints  $(4, 7)$  and  $(1, 11)$ . What is the length of the segment?
- 1) 5
  - 2) 7
  - 3) 16
  - 4) 25
- 6 In  $\triangle FGH$ ,  $m\angle F = 42$  and an exterior angle at vertex  $H$  has a measure of 104. What is  $m\angle G$ ?
- 1) 34
  - 2) 62
  - 3) 76
  - 4) 146

- 7 Which diagram represents a correct construction of equilateral  $\triangle ABC$ , given side  $\overline{AB}$ ?

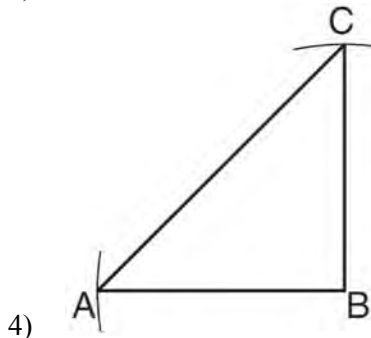
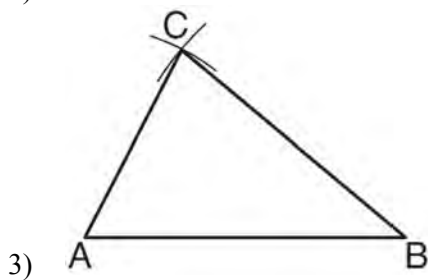
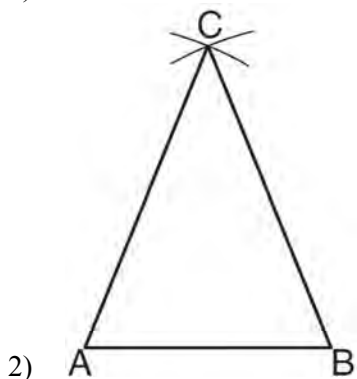
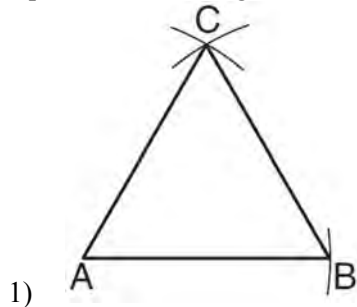

- 8 In the diagram below,  $\triangle ABC$  is circumscribed about circle  $O$  and the sides of  $\triangle ABC$  are tangent to the circle at points  $D$ ,  $E$ , and  $F$ .

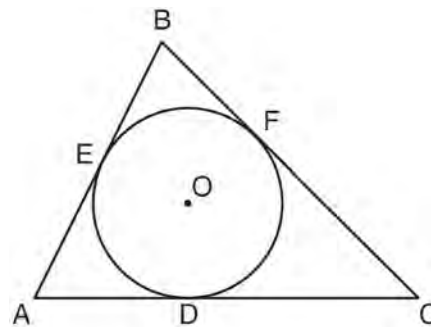

If  $AB = 20$ ,  $AE = 12$ , and  $CF = 15$ , what is the length of  $AC$ ?

- 1) 8  
 2) 15  
 3) 23  
 4) 27
- 9 In  $\triangle ABC$  and  $\triangle DEF$ ,  $\frac{AC}{DF} = \frac{CB}{FE}$ . Which additional information would prove  $\triangle ABC \sim \triangle DEF$ ?
- 1)  $AC = DF$   
 2)  $CB = FE$   
 3)  $\angle ACB \cong \angle DFE$   
 4)  $\angle BAC \cong \angle EDF$
- 10 The angles of triangle  $ABC$  are in the ratio of 8:3:4. What is the measure of the *smallest* angle?
- 1)  $12^\circ$   
 2)  $24^\circ$   
 3)  $36^\circ$   
 4)  $72^\circ$
- 11 When a quadrilateral is reflected over the line  $y = x$ , which geometric relationship is *not* preserved?
- 1) congruence  
 2) orientation  
 3) parallelism  
 4) perpendicularity



- 12 Which equation represents circle  $O$  with center  $(2, -8)$  and radius 9?

- 1)  $(x + 2)^2 + (y - 8)^2 = 9$
- 2)  $(x - 2)^2 + (y + 8)^2 = 9$
- 3)  $(x + 2)^2 + (y - 8)^2 = 81$
- 4)  $(x - 2)^2 + (y + 8)^2 = 81$

- 13 Which statement is the negation of “Two is a prime number” and what is the truth value of the negation?

- 1) Two is not a prime number; false
- 2) Two is not a prime number; true
- 3) A prime number is two; false
- 4) A prime number is two; true

- 14 In the diagram below of circle  $O$ , chords  $\overline{AB}$  and  $\overline{CD}$  intersect at  $E$ .

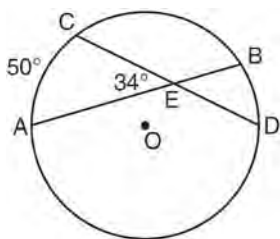

If  $m\angle AEC = 34$  and  $m\widehat{AC} = 50$ , what is  $m\widehat{DB}$ ?

- 1) 16
  - 2) 18
  - 3) 68
  - 4) 118
- 15 The volume of a rectangular prism is 144 cubic inches. The height of the prism is 8 inches. Which measurements, in inches, could be the dimensions of the base?
- 1) 3.3 by 5.5
  - 2) 2.5 by 7.2
  - 3) 12 by 8
  - 4) 9 by 9

- 16 The diagram below shows a pair of congruent triangles, with  $\angle ADB \cong \angle CDB$  and  $\angle ABD \cong \angle CBD$ .

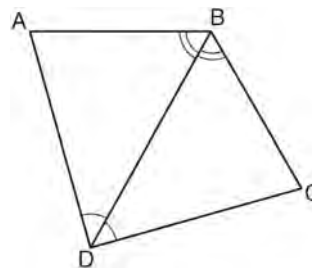

Which statement must be true?

- 1)  $\angle ADB \cong \angle CBD$
  - 2)  $\angle ABC \cong \angle ADC$
  - 3)  $\overline{AB} \cong \overline{CD}$
  - 4)  $\overline{AD} \cong \overline{CD}$
- 17 What is an equation of the line that is perpendicular to the line whose equation is  $y = \frac{3}{5}x - 2$  and that passes through the point  $(3, -6)$ ?
- 1)  $y = \frac{5}{3}x - 11$
  - 2)  $y = -\frac{5}{3}x + 11$
  - 3)  $y = -\frac{5}{3}x - 1$
  - 4)  $y = \frac{5}{3}x + 1$
- 18 Point  $A$  lies in plane  $\mathcal{B}$ . How many lines can be drawn perpendicular to plane  $\mathcal{B}$  through point  $A$ ?
- 1) one
  - 2) two
  - 3) zero
  - 4) infinite

- 19 In the diagram below of isosceles trapezoid  $ABCD$ ,  $AB = CD = 25$ ,  $AD = 26$ , and  $BC = 12$ .

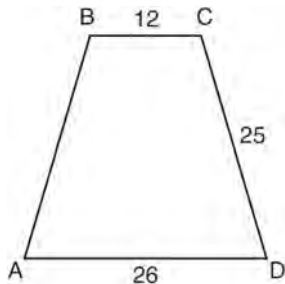

What is the length of an altitude of the trapezoid?

- 1) 7
- 2) 14
- 3) 19
- 4) 24

- 20 What is an equation of circle  $O$  shown in the graph below?

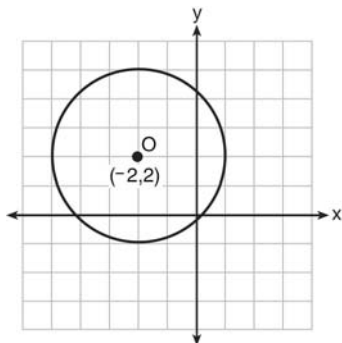

- 1)  $(x + 2)^2 + (y - 2)^2 = 9$
- 2)  $(x + 2)^2 + (y - 2)^2 = 3$
- 3)  $(x - 2)^2 + (y + 2)^2 = 9$
- 4)  $(x - 2)^2 + (y + 2)^2 = 3$

- 21 The diagram below represents a rectangular solid.

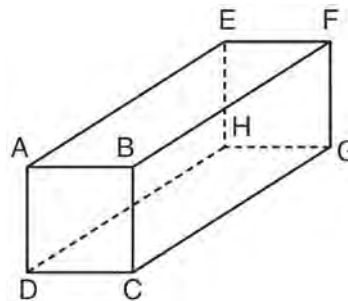

Which statement must be true?

- 1)  $\overline{EH}$  and  $\overline{BC}$  are coplanar
- 2)  $\overline{FG}$  and  $\overline{AB}$  are coplanar
- 3)  $\overline{EH}$  and  $\overline{AD}$  are skew
- 4)  $\overline{FG}$  and  $\overline{CG}$  are skew

- 22 In  $\triangle RST$ ,  $m\angle R = 58$  and  $m\angle S = 73$ . Which inequality is true?

- 1)  $RT < TS < RS$
- 2)  $RS < RT < TS$
- 3)  $RT < RS < TS$
- 4)  $RS < TS < RT$

- 23 The number of degrees in the sum of the interior angles of a pentagon is

- 1) 72
- 2) 360
- 3) 540
- 4) 720

- 24 What is the equation of a line passing through  $(2, -1)$  and parallel to the line represented by the equation  $y = 2x + 1$ ?

- 1)  $y = -\frac{1}{2}x$
- 2)  $y = -\frac{1}{2}x + 1$
- 3)  $y = 2x - 5$
- 4)  $y = 2x - 1$

- 25 The coordinates of the endpoints of  $\overline{AB}$  are  $A(0,0)$  and  $B(0,6)$ . The equation of the perpendicular bisector of  $\overline{AB}$  is
- 1)  $x = 0$
  - 2)  $x = 3$
  - 3)  $y = 0$
  - 4)  $y = 3$

- 26 In the diagram below, point  $P$  is the centroid of  $\triangle ABC$ .

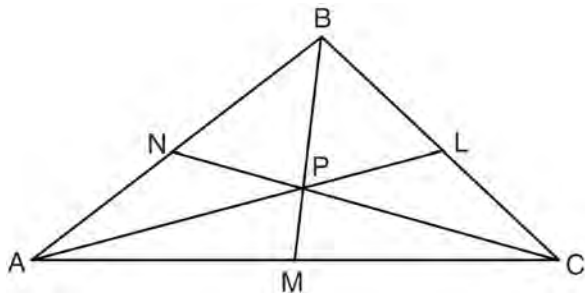

If  $PM = 2x + 5$  and  $BP = 7x + 4$ , what is the length of  $\overline{PM}$ ?

- 1) 9
  - 2) 2
  - 3) 18
  - 4) 27
- 27 In  $\triangle PQR$ ,  $\angle PRQ$  is a right angle and  $\overline{RT}$  is drawn perpendicular to hypotenuse  $\overline{PQ}$ . If  $PT = x$ ,  $RT = 6$ , and  $TQ = 4x$ , what is the length of  $\overline{PQ}$ ?
- 1) 9
  - 2) 12
  - 3) 3
  - 4) 15
- 28 In  $\triangle ABC$ ,  $AB = 5$  feet and  $BC = 3$  feet. Which inequality represents all possible values for the length of  $\overline{AC}$ , in feet?
- 1)  $2 \leq AC \leq 8$
  - 2)  $2 < AC < 8$
  - 3)  $3 \leq AC \leq 7$
  - 4)  $3 < AC < 7$

- 29 In the diagram below, two parallel lines intersect circle  $O$  at points  $A, B, C,$  and  $D$ , with  $m\widehat{AB} = x + 20$  and  $m\widehat{DC} = 2x - 20$ . Find  $m\widehat{AB}$ .

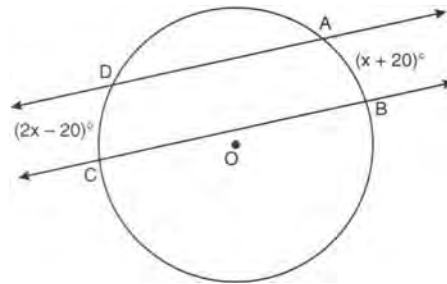

- 30 In the diagram below, point  $M$  is located on  $\overleftrightarrow{AB}$ . Sketch the locus of points that are 1 unit from  $\overleftrightarrow{AB}$  and the locus of points 2 units from point  $M$ . Label with an **X** all points that satisfy both conditions.



- 31 Determine whether the two lines represented by the equations  $y = 2x + 3$  and  $2y + x = 6$  are parallel, perpendicular, or neither. Justify your response.

- 32 The coordinates of the vertices of  $\triangle RST$  are  $R(-2, 3)$ ,  $S(4, 4)$ , and  $T(2, -2)$ . Triangle  $R'S'T'$  is the image of  $\triangle RST$  after a rotation of  $90^\circ$  about the origin. State the coordinates of the vertices of  $\triangle R'S'T'$ . [The use of the set of axes below is optional.]

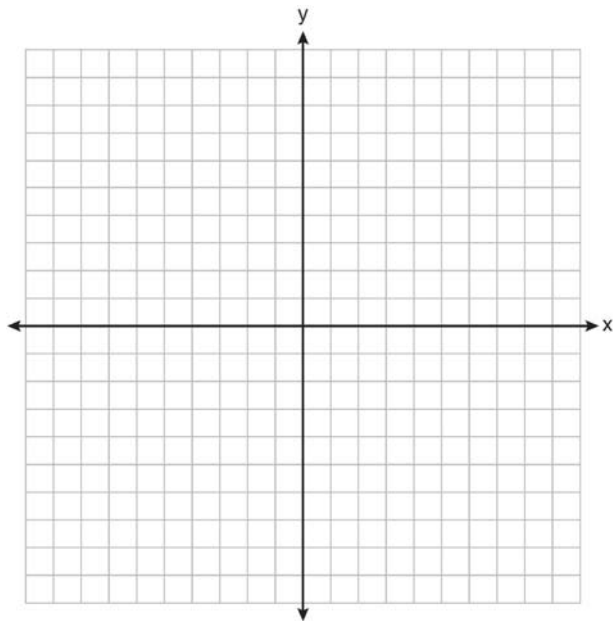

- 33 On the diagram below, use a compass and straightedge to construct the bisector of  $\angle XYZ$ . [Leave all construction marks.]

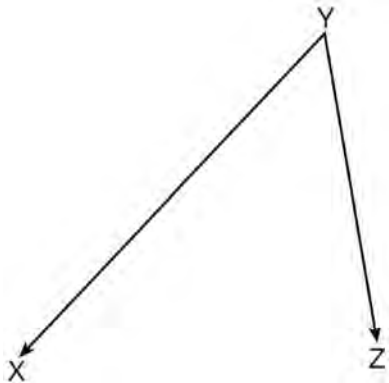

- 34 In the diagram below of circle  $O$ , diameter  $\overline{AB}$  is perpendicular to chord  $\overline{CD}$  at  $E$ . If  $AO = 10$  and  $BE = 4$ , find the length of  $\overline{CE}$ .

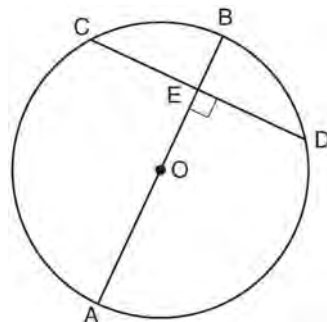

- 35 Triangle  $ABC$  has coordinates  $A(2, -2)$ ,  $B(2, 1)$ , and  $C(4, -2)$ . Triangle  $A'B'C'$  is the image of  $\triangle ABC$  under  $T_{5, -2}$ . On the set of axes below, graph and label  $\triangle ABC$  and its image,  $\triangle A'B'C'$ . Determine the relationship between the area of  $\triangle ABC$  and the area of  $\triangle A'B'C'$ . Justify your response.

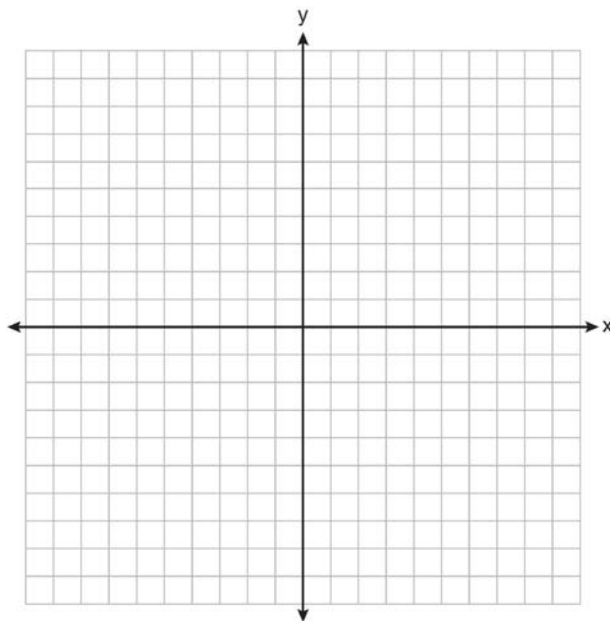

- 36 A paint can is in the shape of a right circular cylinder. The volume of the paint can is  $600\pi$  cubic inches and its altitude is 12 inches. Find the radius, in inches, of the base of the paint can. Express the answer in simplest radical form. Find, to the nearest tenth of a square inch, the lateral area of the paint can.
- 37 Triangle  $HKL$  has vertices  $H(-7, 2)$ ,  $K(3, -4)$ , and  $L(5, 4)$ . The midpoint of  $\overline{HL}$  is  $M$  and the midpoint of  $\overline{LK}$  is  $N$ . Determine and state the coordinates of points  $M$  and  $N$ . Justify the statement:  $\overline{MN}$  is parallel to  $\overline{HK}$ . [The use of the set of axes below is optional.]

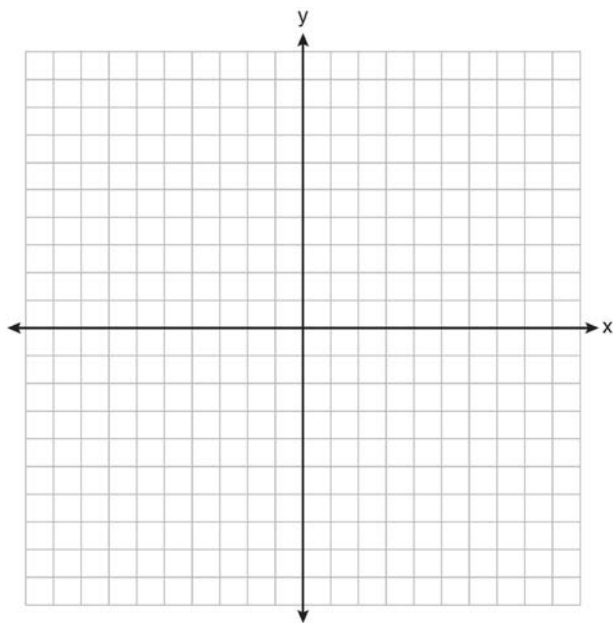

- 38 In the diagram below of quadrilateral  $ABCD$ ,  $\overline{AD} \cong \overline{BC}$  and  $\angle DAE \cong \angle BCE$ . Line segments  $AC$ ,  $DB$ , and  $FG$  intersect at  $E$ .  
Prove:  $\triangle AEF \cong \triangle CEG$

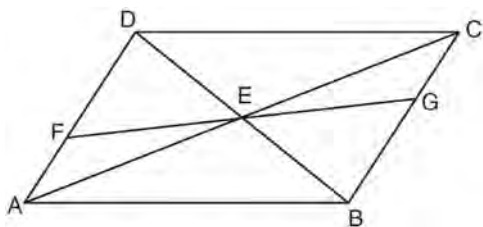

0612ge

- 1 Triangle  $ABC$  is graphed on the set of axes below.

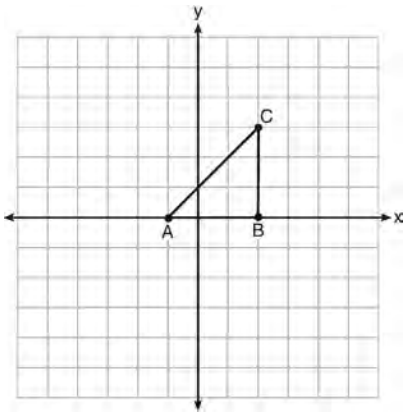

Which transformation produces an image that is similar to, but *not* congruent to,  $\triangle ABC$ ?

- 1)  $T_{2,3}$
  - 2)  $D_2$
  - 3)  $r_{y=x}$
  - 4)  $R_{90}$
- 2 A student wrote the sentence “4 is an odd integer.” What is the negation of this sentence and the truth value of the negation?

- 1) 3 is an odd integer; true
- 2) 4 is not an odd integer; true
- 3) 4 is not an even integer; false
- 4) 4 is an even integer; false

- 3 As shown in the diagram below,  $\overleftrightarrow{EF}$  intersects planes  $\mathcal{P}$ ,  $Q$ , and  $\mathcal{R}$ .

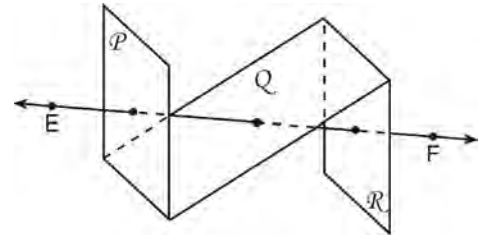

If  $\overleftrightarrow{EF}$  is perpendicular to planes  $\mathcal{P}$  and  $\mathcal{R}$ , which statement must be true?

- 1) Plane  $\mathcal{P}$  is perpendicular to plane  $Q$ .
  - 2) Plane  $\mathcal{R}$  is perpendicular to plane  $\mathcal{P}$ .
  - 3) Plane  $\mathcal{P}$  is parallel to plane  $Q$ .
  - 4) Plane  $\mathcal{R}$  is parallel to plane  $\mathcal{P}$ .
- 4 In the diagram below,  $LATE$  is an isosceles trapezoid with  $\overline{LE} \cong \overline{AT}$ ,  $\overline{LA} = 24$ ,  $\overline{ET} = 40$ , and  $\overline{AT} = 10$ . Altitudes  $\overline{LF}$  and  $\overline{AG}$  are drawn.

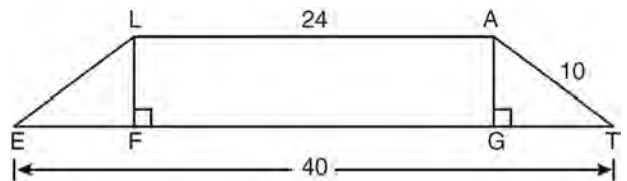

What is the length of  $\overline{LF}$ ?

- 1) 6
- 2) 8
- 3) 3
- 4) 4

- 5 In the diagram below of circle  $O$ , diameter  $\overline{AB}$  is parallel to chord  $\overline{CD}$ .

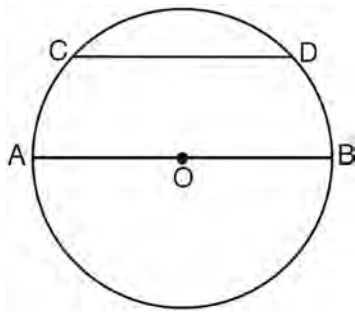

If  $m\widehat{CD} = 70$ , what is  $m\widehat{AC}$ ?

- 1) 110
  - 2) 70
  - 3) 55
  - 4) 35
- 6 In the diagram below of  $\overline{ABCD}$ ,  $\overline{AC} \cong \overline{BD}$ .



Using this information, it could be proven that

- 1)  $BC = AB$
  - 2)  $AB = CD$
  - 3)  $AD - BC = CD$
  - 4)  $AB + CD = AD$
- 7 The diameter of a sphere is 15 inches. What is the volume of the sphere, to the nearest tenth of a cubic inch?
- 1) 706.9
  - 2) 1767.1
  - 3) 2827.4
  - 4) 14,137.2

- 8 The diagram below shows the construction of  $\overleftrightarrow{AB}$  through point  $P$  parallel to  $\overleftrightarrow{CD}$ .

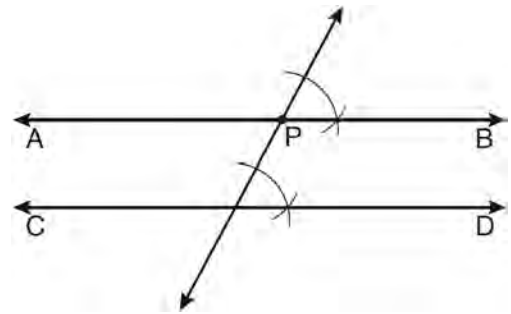

Which theorem justifies this method of construction?

- 1) If two lines in a plane are perpendicular to a transversal at different points, then the lines are parallel.
  - 2) If two lines in a plane are cut by a transversal to form congruent corresponding angles, then the lines are parallel.
  - 3) If two lines in a plane are cut by a transversal to form congruent alternate interior angles, then the lines are parallel.
  - 4) If two lines in a plane are cut by a transversal to form congruent alternate exterior angles, then the lines are parallel.
- 9 Parallelogram  $ABCD$  has coordinates  $A(1,5)$ ,  $B(6,3)$ ,  $C(3,-1)$ , and  $D(-2,1)$ . What are the coordinates of  $E$ , the intersection of diagonals  $\overline{AC}$  and  $\overline{BD}$ ?
- 1)  $(2,2)$
  - 2)  $(4.5,1)$
  - 3)  $(3.5,2)$
  - 4)  $(-1,3)$
- 10 What is the equation of a circle whose center is 4 units above the origin in the coordinate plane and whose radius is 6?
- 1)  $x^2 + (y - 6)^2 = 16$
  - 2)  $(x - 6)^2 + y^2 = 16$
  - 3)  $x^2 + (y - 4)^2 = 36$
  - 4)  $(x - 4)^2 + y^2 = 36$

- 11 In the diagram of  $\triangle ABC$  shown below,  $D$  is the midpoint of  $\overline{AB}$ ,  $E$  is the midpoint of  $\overline{BC}$ , and  $F$  is the midpoint of  $\overline{AC}$ .

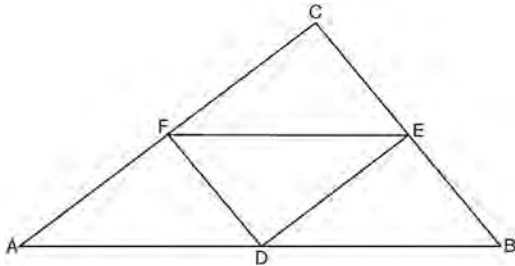

If  $AB = 20$ ,  $BC = 12$ , and  $AC = 16$ , what is the perimeter of trapezoid  $ABEF$ ?

- 1) 24
  - 2) 36
  - 3) 40
  - 4) 44
- 12 In the diagram below,  $\triangle LMO$  is isosceles with  $LO = MO$ .

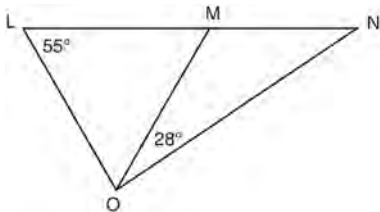

If  $m\angle L = 55$  and  $m\angle NOM = 28$ , what is  $m\angle N$ ?

- 1) 27
  - 2) 28
  - 3) 42
  - 4) 70
- 13 If  $\overleftrightarrow{AB}$  is contained in plane  $\mathcal{P}$ , and  $\overleftrightarrow{AB}$  is perpendicular to plane  $\mathcal{R}$ , which statement is true?

- 1)  $\overleftrightarrow{AB}$  is parallel to plane  $\mathcal{R}$ .
- 2) Plane  $\mathcal{P}$  is parallel to plane  $\mathcal{R}$ .
- 3)  $\overleftrightarrow{AB}$  is perpendicular to plane  $\mathcal{P}$ .
- 4) Plane  $\mathcal{P}$  is perpendicular to plane  $\mathcal{R}$ .

- 14 In the diagram below of  $\triangle ABC$ ,  $\overline{AE} \cong \overline{BE}$ ,  $\overline{AF} \cong \overline{CF}$ , and  $\overline{CD} \cong \overline{BD}$ .

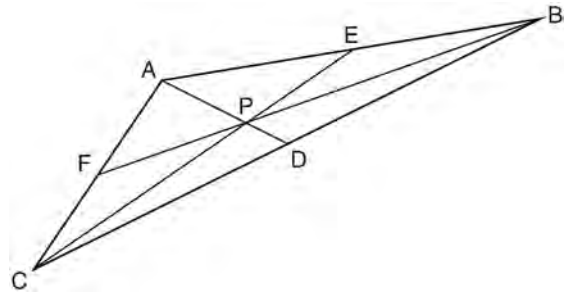

Point  $P$  must be the

- 1) centroid
  - 2) circumcenter
  - 3) incenter
  - 4) orthocenter
- 15 What is the equation of the line that passes through the point  $(-9, 6)$  and is perpendicular to the line  $y = 3x - 5$ ?
- 1)  $y = 3x + 21$
  - 2)  $y = -\frac{1}{3}x - 3$
  - 3)  $y = 3x + 33$
  - 4)  $y = -\frac{1}{3}x + 3$
- 16 In the diagram of  $\triangle ABC$  shown below,  $\overline{DE} \parallel \overline{BC}$ .

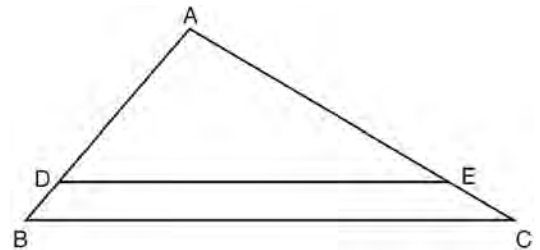

If  $AB = 10$ ,  $AD = 8$ , and  $AE = 12$ , what is the length of  $\overline{EC}$ ?

- 1) 6
- 2) 2
- 3) 3
- 4) 15



17 What is the length of  $\overline{AB}$  with endpoints  $A(-1,0)$  and  $B(4,-3)$ ?

- 1)  $\sqrt{6}$
- 2)  $\sqrt{18}$
- 3)  $\sqrt{34}$
- 4)  $\sqrt{50}$

18 The sum of the interior angles of a polygon of  $n$  sides is

- 1) 360
- 2)  $\frac{360}{n}$
- 3)  $(n - 2) \cdot 180$
- 4)  $\frac{(n - 2) \cdot 180}{n}$

19 What is the slope of a line perpendicular to the line whose equation is  $20x - 2y = 6$ ?

- 1) -10
- 2)  $-\frac{1}{10}$
- 3) 10
- 4)  $\frac{1}{10}$

20 Which graph represents a circle whose equation is  $(x + 2)^2 + y^2 = 16$ ?

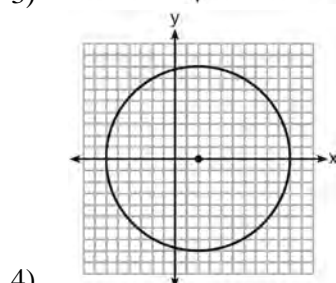
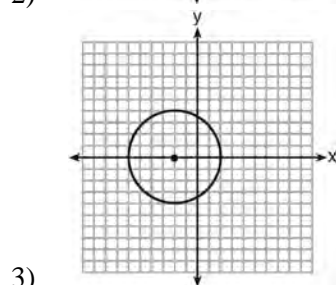
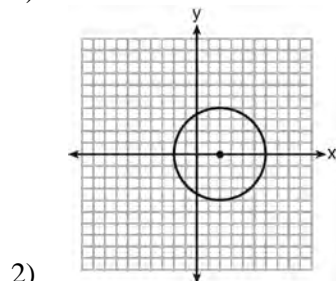
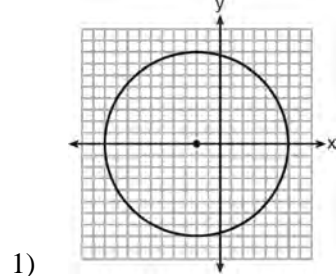

- 21 In circle  $O$  shown below, diameter  $\overline{DB}$  is perpendicular to chord  $\overline{AC}$  at  $E$ .

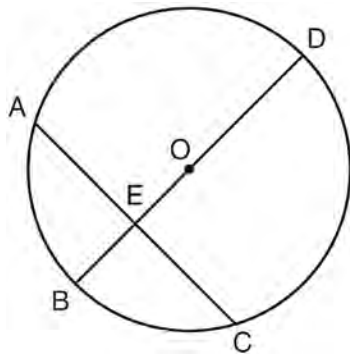

If  $DB = 34$ ,  $AC = 30$ , and  $DE > BE$ , what is the length of  $\overline{BE}$ ?

- 1) 8
  - 2) 9
  - 3) 16
  - 4) 25
- 22 In parallelogram  $ABCD$  shown below, diagonals  $\overline{AC}$  and  $\overline{BD}$  intersect at  $E$ .

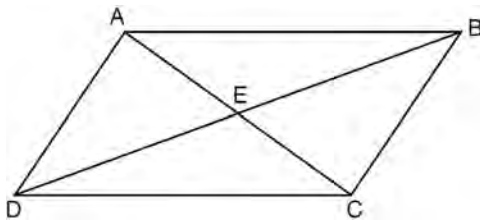

Which statement must be true?

- 1)  $\overline{AC} \cong \overline{DB}$
  - 2)  $\angle ABD \cong \angle CBD$
  - 3)  $\triangle AED \cong \triangle CEB$
  - 4)  $\triangle DCE \cong \triangle BCE$
- 23 Which equation of a circle will have a graph that lies entirely in the first quadrant?
- 1)  $(x - 4)^2 + (y - 5)^2 = 9$
  - 2)  $(x + 4)^2 + (y + 5)^2 = 9$
  - 3)  $(x + 4)^2 + (y + 5)^2 = 25$
  - 4)  $(x - 5)^2 + (y - 4)^2 = 25$

- 24 In the diagram below,  $\triangle ABC \sim \triangle RST$ .

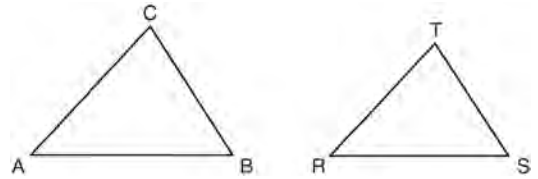

Which statement is *not* true?

- 1)  $\angle A \cong \angle R$
  - 2)  $\frac{AB}{RS} = \frac{BC}{ST}$
  - 3)  $\frac{AB}{BC} = \frac{ST}{RS}$
  - 4)  $\frac{AB + BC + AC}{RS + ST + RT} = \frac{AB}{RS}$
- 25 In the diagram below of  $\triangle ABC$ ,  $\overline{BC}$  is extended to  $D$ .

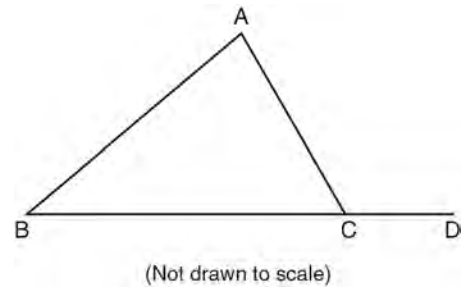

If  $m\angle A = x^2 - 6x$ ,  $m\angle B = 2x - 3$ , and  $m\angle ACD = 9x + 27$ , what is the value of  $x$ ?

- 1) 10
  - 2) 2
  - 3) 3
  - 4) 15
- 26 An equation of the line that passes through  $(2, -1)$  and is parallel to the line  $2y + 3x = 8$  is
- 1)  $y = \frac{3}{2}x - 4$
  - 2)  $y = \frac{3}{2}x + 4$
  - 3)  $y = -\frac{3}{2}x - 2$
  - 4)  $y = -\frac{3}{2}x + 2$

- 27 The graph below shows  $\overline{JT}$  and its image,  $\overline{J'T'}$ , after a transformation.

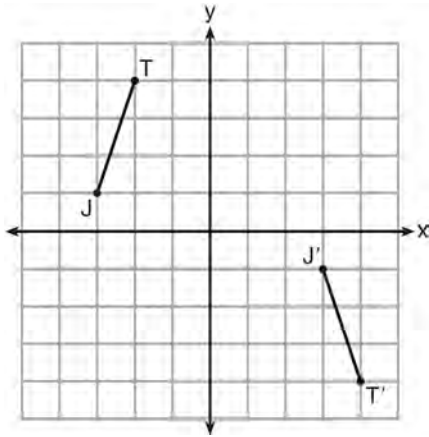

Which transformation would map  $\overline{JT}$  onto  $\overline{J'T'}$ ?

- 1) translation
  - 2) glide reflection
  - 3) rotation centered at the origin
  - 4) reflection through the origin
- 28 Which reason could be used to prove that a parallelogram is a rhombus?
- 1) Diagonals are congruent.
  - 2) Opposite sides are parallel.
  - 3) Diagonals are perpendicular.
  - 4) Opposite angles are congruent.

- 29 Triangle  $TAP$  has coordinates  $T(-1,4)$ ,  $A(2,4)$ , and  $P(2,0)$ . On the set of axes below, graph and label  $\triangle T'A'P'$ , the image of  $\triangle TAP$  after the translation  $(x,y) \rightarrow (x-5,y-1)$ .

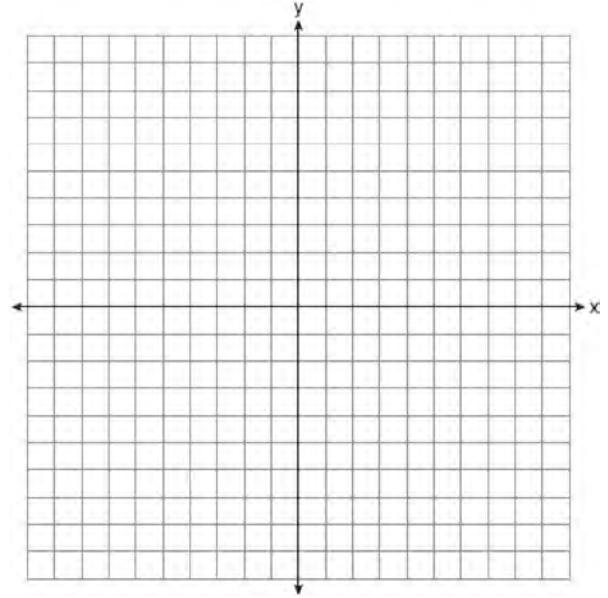

- 30 In the diagram below,  $\ell \parallel m$  and  $\overline{QR} \perp \overline{ST}$  at  $R$ .

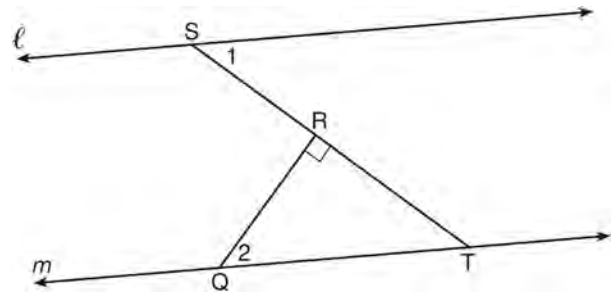

If  $m\angle 1 = 63$ , find  $m\angle 2$ .

- 31 Two lines are represented by the equations  $x + 2y = 4$  and  $4y - 2x = 12$ . Determine whether these lines are parallel, perpendicular, or neither. Justify your answer.

- 32 Using a compass and straightedge, construct the bisector of  $\angle CBA$ . [Leave all construction marks.]

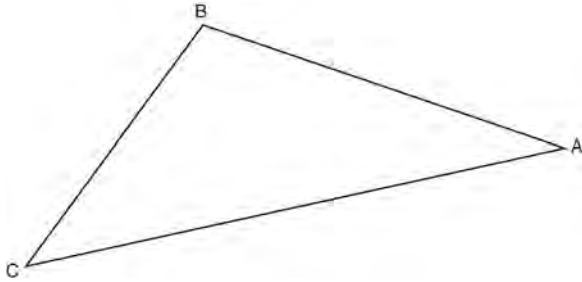

- 33 The cylindrical tank shown in the diagram below is to be painted. The tank is open at the top, and the bottom does *not* need to be painted. Only the outside needs to be painted. Each can of paint covers 600 square feet. How many cans of paint must be purchased to complete the job?

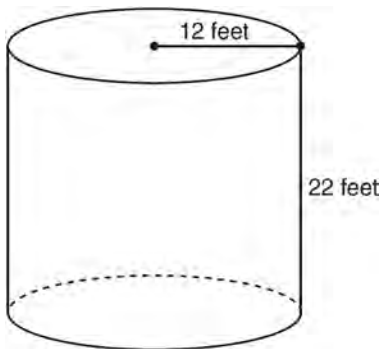

- 34 On the set of axes below, graph the locus of points that are 4 units from the line  $x = 3$  and the locus of points that are 5 units from the point  $(0,2)$ . Label with an **X** all points that satisfy both conditions.

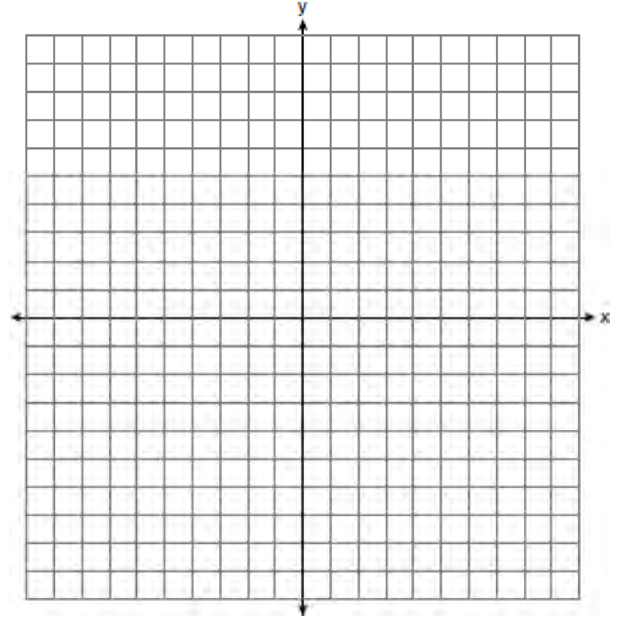

- 35 Given:  $\overline{AD}$  bisects  $\overline{BC}$  at  $E$ .  
 $\overline{AB} \perp \overline{BC}$   
 $\overline{DC} \perp \overline{BC}$   
 Prove:  $\overline{AB} \cong \overline{DC}$

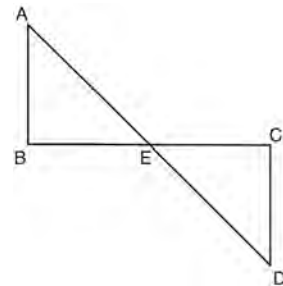

- 36 The coordinates of trapezoid  $ABCD$  are  $A(-4,5)$ ,  $B(1,5)$ ,  $C(1,2)$ , and  $D(-6,2)$ . Trapezoid  $A''B''C''D''$  is the image after the composition  $r_{x\text{-axis}} \circ r_{y=x}$  is performed on trapezoid  $ABCD$ . State the coordinates of trapezoid  $A''B''C''D''$ . [The use of the set of axes below is optional.]

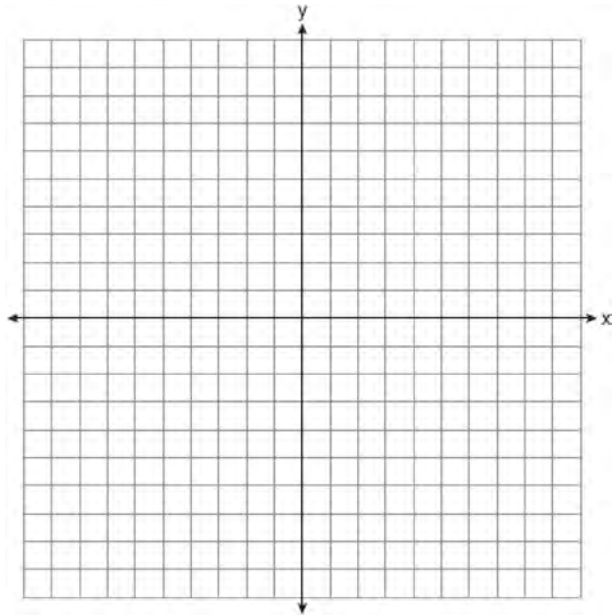

- 37 In the diagram below of circle  $O$ , chords  $\overline{RT}$  and  $\overline{QS}$  intersect at  $M$ . Secant  $\overline{PTR}$  and tangent  $\overline{PS}$  are drawn to circle  $O$ . The length of  $\overline{RM}$  is two more than the length of  $\overline{TM}$ ,  $\overline{QM} = 2$ ,  $\overline{SM} = 12$ , and  $\overline{PT} = 8$ .

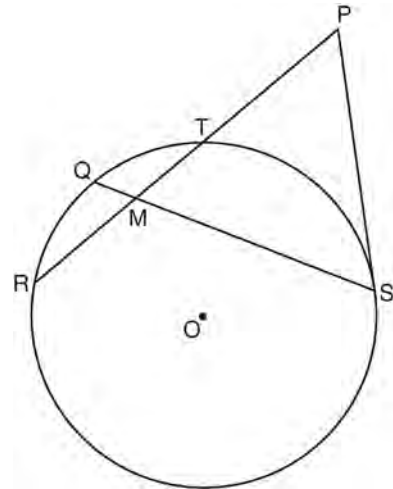

Find the length of  $\overline{RT}$ . Find the length of  $\overline{PS}$ .

- 38 On the set of axes below, solve the system of equations graphically and state the coordinates of all points in the solution.

$$y = (x - 2)^2 - 3$$

$$2y + 16 = 4x$$

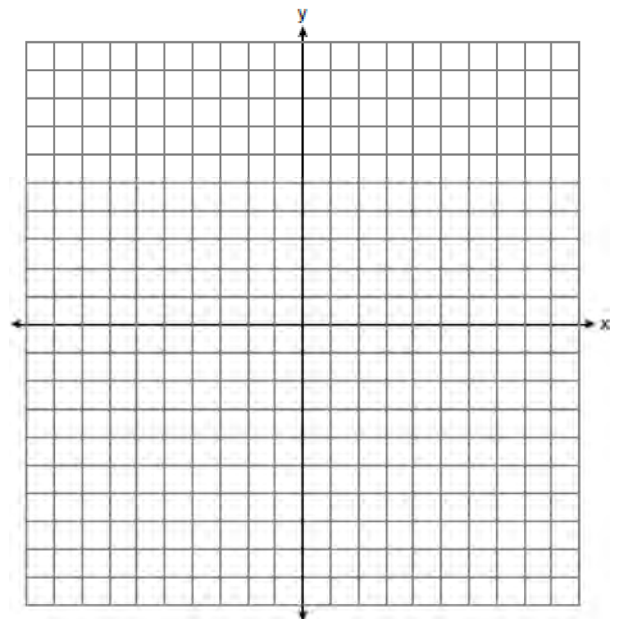

0812ge

- 1 In the diagram below of circle  $O$ , chord  $\overline{AB}$  is parallel to chord  $\overline{GH}$ . Chord  $\overline{CD}$  intersects  $\overline{AB}$  at  $E$  and  $\overline{GH}$  at  $F$ .

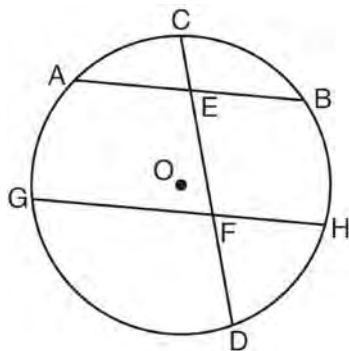

Which statement must always be true?

- 1)  $\widehat{AC} \cong \widehat{CB}$
  - 2)  $\widehat{DH} \cong \widehat{BH}$
  - 3)  $\widehat{AB} \cong \widehat{GH}$
  - 4)  $\widehat{AG} \cong \widehat{BH}$
- 2 The vertices of parallelogram  $ABCD$  are  $A(2, 0)$ ,  $B(0, -3)$ ,  $C(3, -3)$ , and  $D(5, 0)$ . If  $ABCD$  is reflected over the  $x$ -axis, how many vertices remain invariant?
- 1) 1
  - 2) 2
  - 3) 3
  - 4) 0
- 3 Point  $M$  is the midpoint of  $\overline{AB}$ . If the coordinates of  $A$  are  $(-3, 6)$  and the coordinates of  $M$  are  $(-5, 2)$ , what are the coordinates of  $B$ ?
- 1)  $(1, 2)$
  - 2)  $(7, 10)$
  - 3)  $(-4, 4)$
  - 4)  $(-7, -2)$

- 4 When a dilation is performed on a hexagon, which property of the hexagon will *not* be preserved in its image?

- 1) parallelism
- 2) orientation
- 3) length of sides
- 4) measure of angles

- 5 As shown in the diagram below of  $\triangle ABC$ , a compass is used to find points  $D$  and  $E$ , equidistant from point  $A$ . Next, the compass is used to find point  $F$ , equidistant from points  $D$  and  $E$ . Finally, a straightedge is used to draw  $\overrightarrow{AF}$ . Then, point  $G$ , the intersection of  $\overrightarrow{AF}$  and side  $\overline{BC}$  of  $\triangle ABC$ , is labeled.

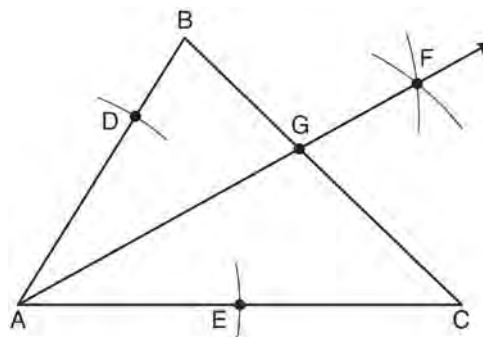

Which statement must be true?

- 1)  $\overrightarrow{AF}$  bisects side  $\overline{BC}$
- 2)  $\overrightarrow{AF}$  bisects  $\angle BAC$
- 3)  $\overrightarrow{AF} \perp \overline{BC}$
- 4)  $\triangle ABG \sim \triangle ACG$

- 6 In the diagram of  $\triangle JEA$  below,  $m\angle JEA = 90$  and  $m\angle EAJ = 48$ . Line segment  $MS$  connects points  $M$  and  $S$  on the triangle, such that  $m\angle EMS = 59$ .

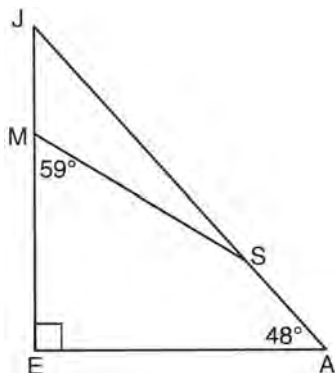

What is  $m\angle JSM$ ?

- 1) 163
  - 2) 121
  - 3) 42
  - 4) 17
- 7 In  $\triangle AED$  with  $\overline{ABCD}$  shown in the diagram below,  $\overline{EB}$  and  $\overline{EC}$  are drawn.

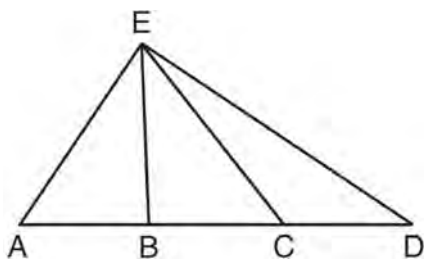

If  $\overline{AB} \cong \overline{CD}$ , which statement could always be proven?

- 1)  $\overline{AC} \cong \overline{DB}$
- 2)  $\overline{AE} \cong \overline{ED}$
- 3)  $\overline{AB} \cong \overline{BC}$
- 4)  $\overline{EC} \cong \overline{EA}$

- 8 Given that  $ABCD$  is a parallelogram, a student wrote the proof below to show that a pair of its opposite angles are congruent.

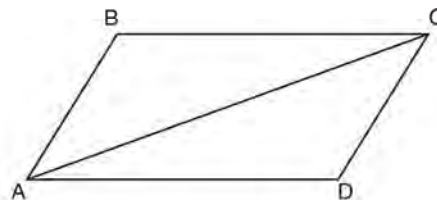

Statement	Reason
1. $ABCD$ is a parallelogram.	1. Given
2. $\overline{BC} \cong \overline{AD}$ $\overline{AB} \cong \overline{DC}$	2. Opposite sides of a parallelogram are congruent.
3. $\overline{AC} \cong \overline{CA}$	3. Reflexive Postulate of Congruency
4. $\triangle ABC \cong \triangle CDA$	4. Side-Side-Side
5. $\angle B \cong \angle D$	5. _____

What is the reason justifying that  $\angle B \cong \angle D$ ?

- 1) Opposite angles in a quadrilateral are congruent.
  - 2) Parallel lines have congruent corresponding angles.
  - 3) Corresponding parts of congruent triangles are congruent.
  - 4) Alternate interior angles in congruent triangles are congruent.
- 9 The equation of a circle with its center at  $(-3, 5)$  and a radius of 4 is
- 1)  $(x + 3)^2 + (y - 5)^2 = 4$
  - 2)  $(x - 3)^2 + (y + 5)^2 = 4$
  - 3)  $(x + 3)^2 + (y - 5)^2 = 16$
  - 4)  $(x - 3)^2 + (y + 5)^2 = 16$

- 10 In the diagram below of  $\triangle DAE$  and  $\triangle BCE$ ,  $\overline{AB}$  and  $\overline{CD}$  intersect at  $E$ , such that  $\overline{AE} \cong \overline{CE}$  and  $\angle BCE \cong \angle DAE$ .

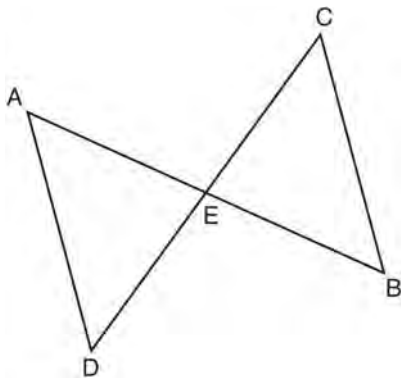

Triangle  $DAE$  can be proved congruent to triangle  $BCE$  by

- 1) ASA
  - 2) SAS
  - 3) SSS
  - 4) HL
- 11 As shown in the diagram below,  $\overline{FJ}$  is contained in plane  $R$ ,  $\overline{BC}$  and  $\overline{DE}$  are contained in plane  $S$ , and  $\overline{FJ}$ ,  $\overline{BC}$ , and  $\overline{DE}$  intersect at  $A$ .

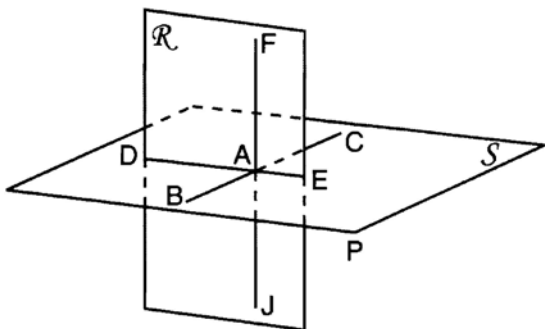

Which fact is *not* sufficient to show that planes  $R$  and  $S$  are perpendicular?

- 1)  $\overline{FA} \perp \overline{DE}$
- 2)  $\overline{AD} \perp \overline{AF}$
- 3)  $\overline{BC} \perp \overline{FJ}$
- 4)  $\overline{DE} \perp \overline{BC}$

- 12 What is an equation of the circle shown in the graph below?

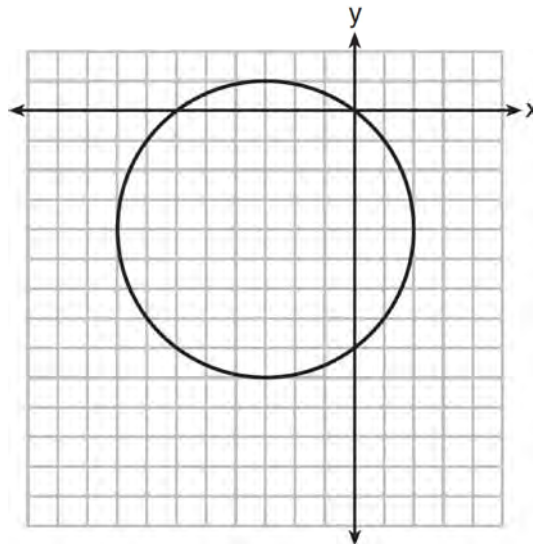

- 1)  $(x - 3)^2 + (y - 4)^2 = 25$
  - 2)  $(x + 3)^2 + (y + 4)^2 = 25$
  - 3)  $(x - 3)^2 + (y - 4)^2 = 10$
  - 4)  $(x + 3)^2 + (y + 4)^2 = 10$
- 13 As shown in the diagram below, lines  $m$  and  $n$  are cut by transversal  $p$ .

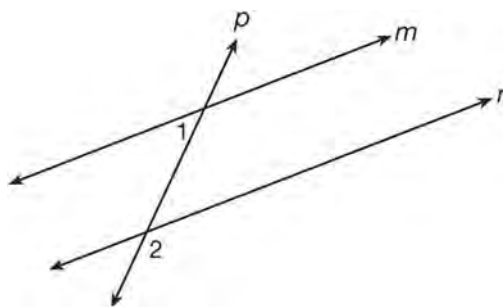

If  $m\angle 1 = 4x + 14$  and  $m\angle 2 = 8x + 10$ , lines  $m$  and  $n$  are parallel when  $x$  equals

- 1) 1
- 2) 6
- 3) 13
- 4) 17



- 14 The angle formed by the radius of a circle and a tangent to that circle has a measure of
- 1)  $45^\circ$
  - 2)  $90^\circ$
  - 3)  $135^\circ$
  - 4)  $180^\circ$
- 15 A sphere is inscribed inside a cube with edges of 6 cm. In cubic centimeters, what is the volume of the sphere, in terms of  $\pi$ ?
- 1)  $12\pi$
  - 2)  $36\pi$
  - 3)  $48\pi$
  - 4)  $288\pi$
- 16 Scalene triangle  $ABC$  is similar to triangle  $DEF$ . Which statement is *false*?
- 1)  $\overline{AB}:BC=DE:EF$
  - 2)  $\overline{AC}:DF=BC:EF$
  - 3)  $\angle ACB \cong \angle DFE$
  - 4)  $\angle ABC \cong \angle EDF$
- 17 Which equation represents a line that is parallel to the line whose equation is  $y = \frac{3}{2}x - 3$  and passes through the point  $(1, 2)$ ?
- 1)  $y = \frac{3}{2}x + \frac{1}{2}$
  - 2)  $y = \frac{2}{3}x + \frac{4}{3}$
  - 3)  $y = \frac{3}{2}x - 2$
  - 4)  $y = -\frac{2}{3}x + \frac{8}{3}$
- 18 Lines  $a$  and  $b$  intersect at point  $P$ . Line  $c$  passes through  $P$  and is perpendicular to the plane containing lines  $a$  and  $b$ . Which statement must be true?
- 1) Lines  $a$ ,  $b$ , and  $c$  are coplanar.
  - 2) Line  $a$  is perpendicular to line  $b$ .
  - 3) Line  $c$  is perpendicular to both line  $a$  and line  $b$ .
  - 4) Line  $c$  is perpendicular to line  $a$  or line  $b$ , but not both.

- 19 As shown in the diagram of  $\triangle ACD$  below,  $B$  is a point on  $\overline{AC}$  and  $\overline{DB}$  is drawn.

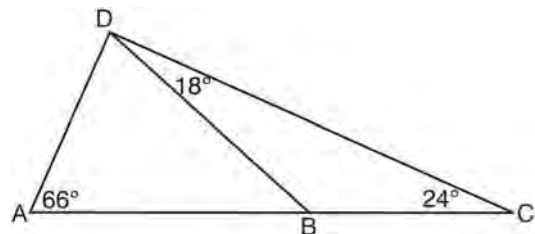

If  $m\angle A = 66$ ,  $m\angle CDB = 18$ , and  $m\angle C = 24$ , what is the longest side of  $\triangle ABD$ ?

- 1)  $\overline{AB}$
  - 2)  $\overline{DC}$
  - 3)  $\overline{AD}$
  - 4)  $\overline{BD}$
- 20 In  $\triangle ABC$  shown below,  $P$  is the centroid and  $BF = 18$ .

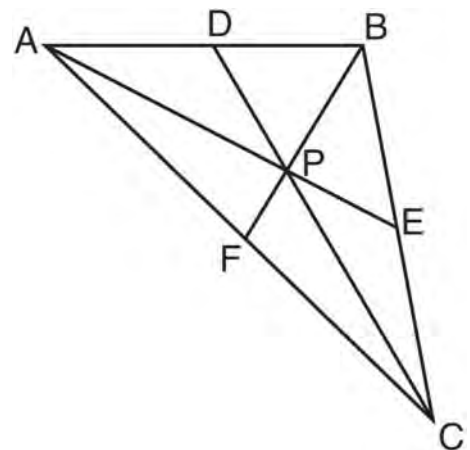

What is the length of  $\overline{BP}$ ?

- 1) 6
- 2) 9
- 3) 3
- 4) 12

- 21 In the diagram below,  $\overline{EF}$  is the median of trapezoid  $ABCD$ .

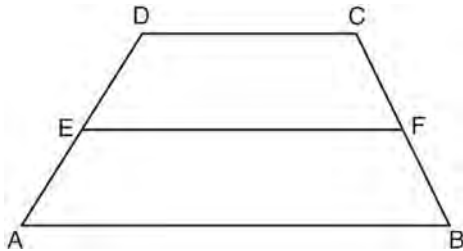

If  $AB = 5x - 9$ ,  $DC = x + 3$ , and  $EF = 2x + 2$ , what is the value of  $x$ ?

- 1) 5
  - 2) 2
  - 3) 7
  - 4) 8
- 22 In the diagram below of  $\triangle ABC$ ,  $\overline{AB} \cong \overline{AC}$ ,  $m\angle A = 3x$ , and  $m\angle B = x + 20$ .

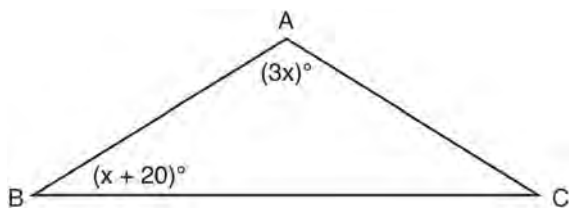

What is the value of  $x$ ?

- 1) 10
  - 2) 28
  - 3) 32
  - 4) 40
- 23 For which polygon does the sum of the measures of the interior angles equal the sum of the measures of the exterior angles?
- 1) hexagon
  - 2) pentagon
  - 3) quadrilateral
  - 4) triangle
- 24 For a triangle, which two points of concurrence could be located outside the triangle?
- 1) incenter and centroid
  - 2) centroid and orthocenter
  - 3) incenter and circumcenter
  - 4) circumcenter and orthocenter

- 25 The slope of line  $\ell$  is  $-\frac{1}{3}$ . What is an equation of a line that is perpendicular to line  $\ell$ ?

- 1)  $y + 2 = \frac{1}{3}x$
- 2)  $-2x + 6 = 6y$
- 3)  $9x - 3y = 27$
- 4)  $3x + y = 0$

- 26 Which type of triangle can be drawn using the points  $(-2, 3)$ ,  $(-2, -7)$ , and  $(4, -5)$ ?

- 1) scalene
- 2) isosceles
- 3) equilateral
- 4) no triangle can be drawn

- 27 In the diagram below,  $\overline{DE}$  joins the midpoints of two sides of  $\triangle ABC$ .

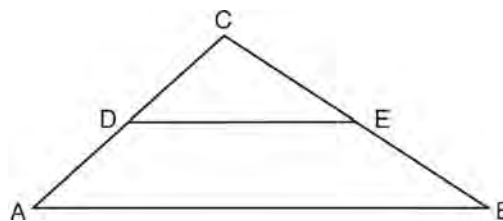

Which statement is *not* true?

- 1)  $CE = \frac{1}{2}CB$
  - 2)  $DE = \frac{1}{2}AB$
  - 3) area of  $\triangle CDE = \frac{1}{2}$  area of  $\triangle CAB$
  - 4) perimeter of  $\triangle CDE = \frac{1}{2}$  perimeter of  $\triangle CAB$
- 28 Which equation represents the line that is perpendicular to  $2y = x + 2$  and passes through the point  $(4, 3)$ ?
- 1)  $y = \frac{1}{2}x - 5$
  - 2)  $y = \frac{1}{2}x + 1$
  - 3)  $y = -2x + 11$
  - 4)  $y = -2x - 5$

- 29 Write the negation of the statement “2 is a prime number,” and determine the truth value of the negation.
- 30 The coordinates of the vertices of  $\triangle ABC$  are  $A(1, 2)$ ,  $B(-4, 3)$ , and  $C(-3, -5)$ . State the coordinates of  $\triangle A'B'C'$ , the image of  $\triangle ABC$  after a rotation of  $90^\circ$  about the origin. [The use of the set of axes below is optional.]

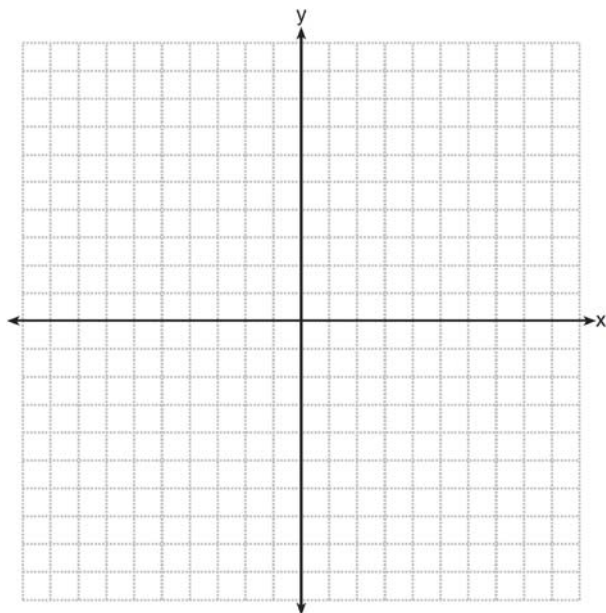

- 31 A cylinder has a height of 7 cm and a base with a diameter of 10 cm. Determine the volume, in cubic centimeters, of the cylinder in terms of  $\pi$ .
- 32 The coordinates of the endpoints of  $\overline{FG}$  are  $(-4, 3)$  and  $(2, 5)$ . Find the length of  $\overline{FG}$  in simplest radical form.

- 33 Using a compass and straightedge, construct a line perpendicular to  $\overline{AB}$  through point  $P$ . [Leave all construction marks.]

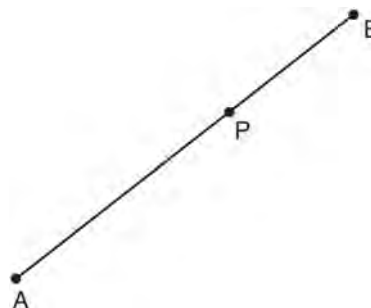

- 34 The graph below shows the locus of points equidistant from the  $x$ -axis and  $y$ -axis. On the same set of axes, graph the locus of points 3 units from the line  $x = 0$ . Label with an **X** all points that satisfy both conditions.

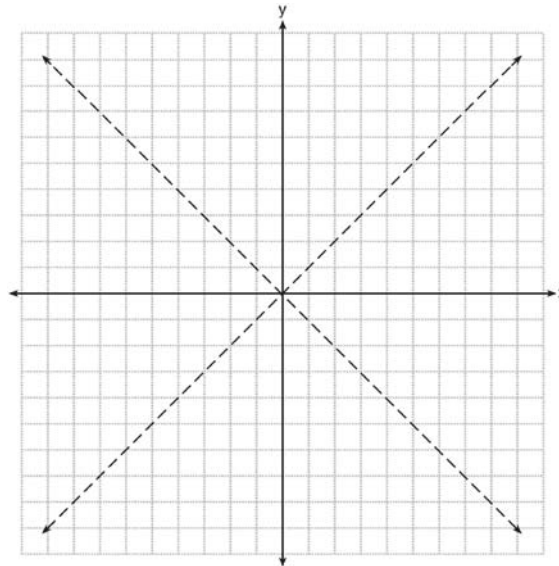

- 35 As shown in the diagram below, the diagonals of parallelogram  $QRST$  intersect at  $E$ . If  $QE = x^2 + 6x$ ,  $SE = x + 14$ , and  $TE = 6x - 1$ , determine  $TE$  algebraically.

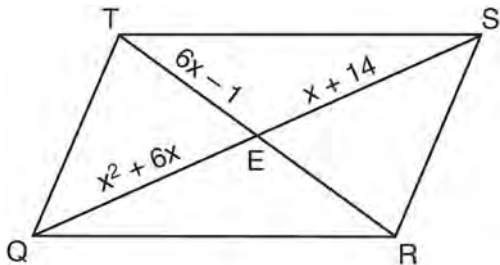

- 36 The vertices of  $\triangle RST$  are  $R(-6, 5)$ ,  $S(-7, -2)$ , and  $T(1, 4)$ . The image of  $\triangle RST$  after the composition  $T_{-2, 3} \circ r_{y=x}$  is  $\triangle R''S''T''$ . State the coordinates of  $\triangle R''S''T''$ . [The use of the set of axes below is optional.]

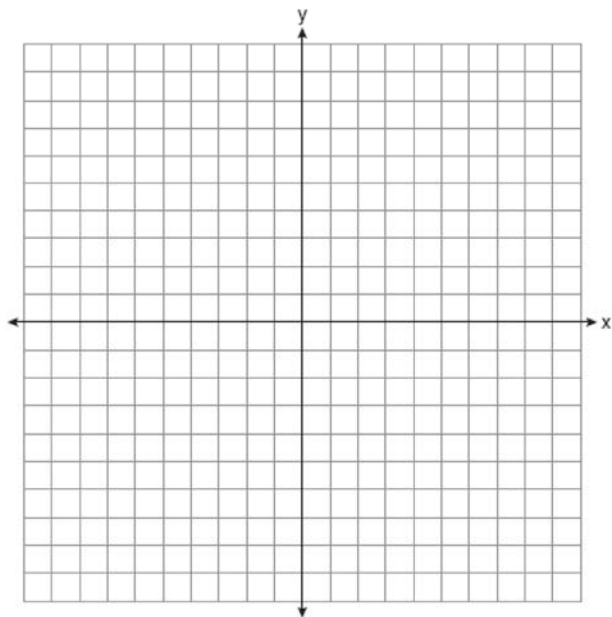

- 37 On the set of axes below, solve the following system of equations graphically and state the coordinates of *all* points in the solution.

$$(x + 3)^2 + (y - 2)^2 = 25$$

$$2y + 4 = -x$$

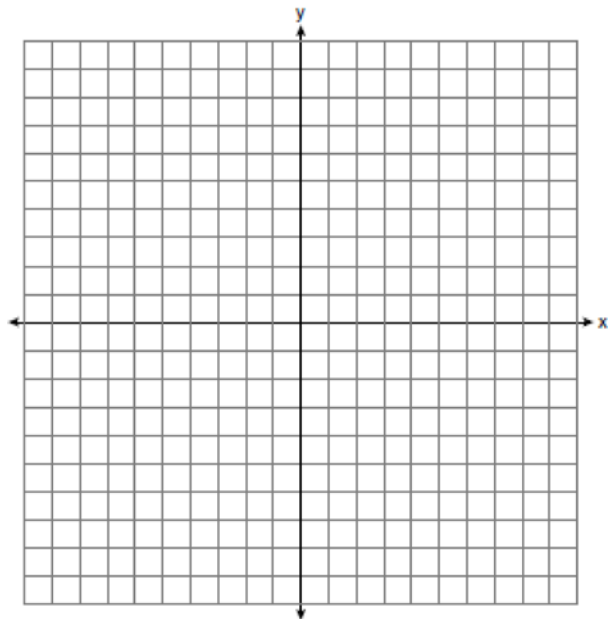

- 38 Chords  $\overline{AB}$  and  $\overline{CD}$  intersect at  $E$  in circle  $O$ , as shown in the diagram below. Secant  $\overline{FDA}$  and tangent  $\overline{FB}$  are drawn to circle  $O$  from external point  $F$  and chord  $\overline{AC}$  is drawn. The  $m\widehat{DA} = 56$ ,  $m\widehat{DB} = 112$ , and the ratio of  $m\widehat{AC} : m\widehat{CB} = 3 : 1$ .

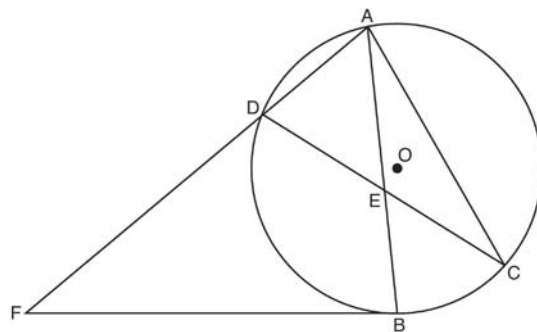

Determine  $m\angle CEB$ . Determine  $m\angle F$ . Determine  $m\angle DAC$ .

0113ge

- 1 If  $\triangle MNP \cong \triangle VWX$  and  $\overline{PM}$  is the shortest side of  $\triangle MNP$ , what is the shortest side of  $\triangle VWX$ ?
- 1)  $\overline{XV}$
  - 2)  $\overline{WX}$
  - 3)  $\overline{VW}$
  - 4)  $\overline{NP}$

- 2 In circle  $O$  shown in the diagram below, chords  $\overline{AB}$  and  $\overline{CD}$  are parallel.

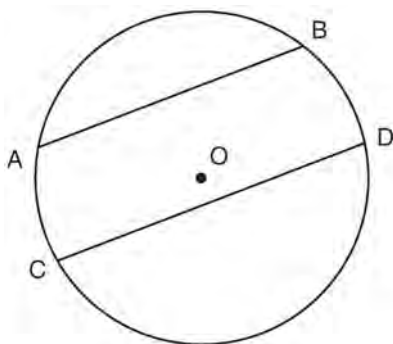

If  $m\widehat{AB} = 104$  and  $m\widehat{CD} = 168$ , what is  $m\widehat{BD}$ ?

- 1) 38
  - 2) 44
  - 3) 88
  - 4) 96
- 3 As shown in the diagram below,  $\overline{CD}$  is a median of  $\triangle ABC$ .

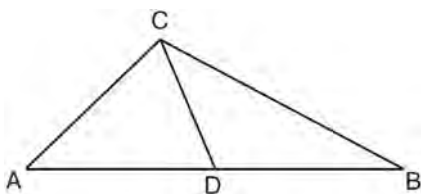

Which statement is *always* true?

- 1)  $\overline{AD} \cong \overline{DB}$
- 2)  $\overline{AC} \cong \overline{AD}$
- 3)  $\angle ACD \cong \angle CDB$
- 4)  $\angle BCD \cong \angle ACD$

- 4 In the diagram below, under which transformation is  $\triangle A'B'C'$  the image of  $\triangle ABC$ ?

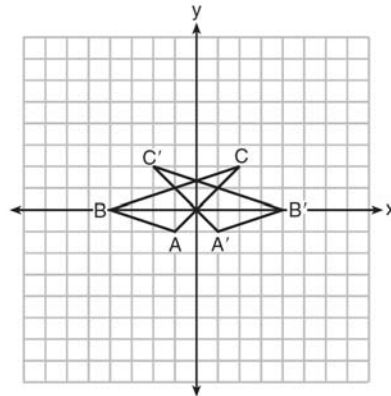

- 1)  $D_2$
  - 2)  $r_{x\text{-axis}}$
  - 3)  $r_{y\text{-axis}}$
  - 4)  $(x, y) \rightarrow (x - 2, y)$
- 5 Line segment  $AB$  is a diameter of circle  $O$  whose center has coordinates  $(6, 8)$ . What are the coordinates of point  $B$  if the coordinates of point  $A$  are  $(4, 2)$ ?
- 1)  $(1, 3)$
  - 2)  $(5, 5)$
  - 3)  $(8, 14)$
  - 4)  $(10, 10)$
- 6 Plane  $\mathcal{A}$  and plane  $\mathcal{B}$  are two distinct planes that are both perpendicular to line  $\ell$ . Which statement about planes  $\mathcal{A}$  and  $\mathcal{B}$  is true?
- 1) Planes  $\mathcal{A}$  and  $\mathcal{B}$  have a common edge, which forms a line.
  - 2) Planes  $\mathcal{A}$  and  $\mathcal{B}$  are perpendicular to each other.
  - 3) Planes  $\mathcal{A}$  and  $\mathcal{B}$  intersect each other at exactly one point.
  - 4) Planes  $\mathcal{A}$  and  $\mathcal{B}$  are parallel to each other.

- 7 Triangle  $ABC$  is similar to triangle  $DEF$ . The lengths of the sides of  $\triangle ABC$  are 5, 8, and 11. What is the length of the shortest side of  $\triangle DEF$  if its perimeter is 60?
- 1) 10
  - 2) 12.5
  - 3) 20
  - 4) 27.5

- 8 In the diagram below of right triangle  $ABC$ , altitude  $\overline{CD}$  is drawn to hypotenuse  $\overline{AB}$ .

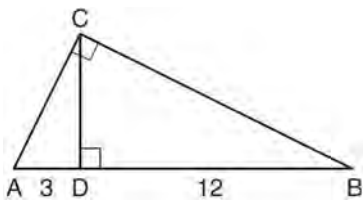

If  $AD = 3$  and  $DB = 12$ , what is the length of altitude  $\overline{CD}$ ?

- 1) 6
  - 2)  $6\sqrt{5}$
  - 3) 3
  - 4)  $3\sqrt{5}$
- 9 The diagram below shows the construction of an equilateral triangle.

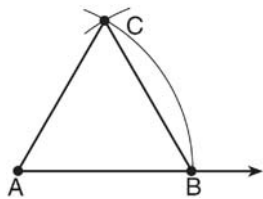

Which statement justifies this construction?

- 1)  $\angle A + \angle B + \angle C = 180$
- 2)  $m\angle A = m\angle B = m\angle C$
- 3)  $AB = AC = BC$
- 4)  $AB + BC > AC$

- 10 What is the slope of the line perpendicular to the line represented by the equation  $2x + 4y = 12$ ?
- 1)  $-2$
  - 2)  $2$
  - 3)  $-\frac{1}{2}$
  - 4)  $\frac{1}{2}$

- 11 Triangle  $ABC$  is shown in the diagram below.

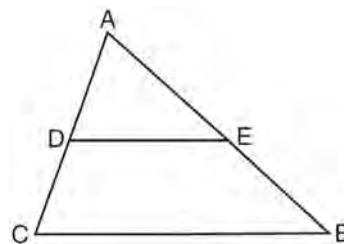

If  $\overline{DE}$  joins the midpoints of  $\overline{AC}$  and  $\overline{AB}$ , which statement is *not* true?

- 1)  $DE = \frac{1}{2} CB$
  - 2)  $\overline{DE} \parallel \overline{CB}$
  - 3)  $\frac{AD}{DC} = \frac{DE}{CB}$
  - 4)  $\triangle ABC \sim \triangle AED$
- 12 The equations  $x^2 + y^2 = 25$  and  $y = 5$  are graphed on a set of axes. What is the solution of this system?
- 1) (0, 0)
  - 2) (5, 0)
  - 3) (0, 5)
  - 4) (5, 5)
- 13 Square  $ABCD$  has vertices  $A(-2, -3)$ ,  $B(4, -1)$ ,  $C(2, 5)$ , and  $D(-4, 3)$ . What is the length of a side of the square?
- 1)  $2\sqrt{5}$
  - 2)  $2\sqrt{10}$
  - 3)  $4\sqrt{5}$
  - 4)  $10\sqrt{2}$

- 14 The diagram below shows  $\triangle ABD$ , with  $\overline{ABC}$ ,  $\overline{BE} \perp \overline{AD}$ , and  $\angle EBD \cong \angle CBD$ .

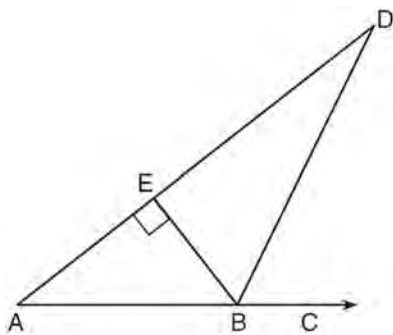

If  $m\angle ABE = 52$ , what is  $m\angle D$ ?

- 1) 26
  - 2) 38
  - 3) 52
  - 4) 64
- 15 As shown in the diagram below,  $\overline{FD}$  and  $\overline{CB}$  intersect at point  $A$  and  $\overline{ET}$  is perpendicular to both  $\overline{FD}$  and  $\overline{CB}$  at  $A$ .

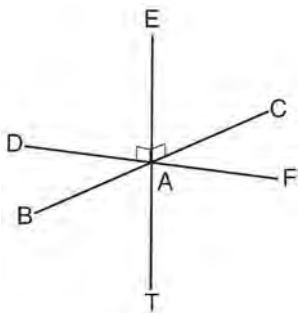

Which statement is *not* true?

- 1)  $\overline{ET}$  is perpendicular to plane  $BAD$ .
- 2)  $\overline{ET}$  is perpendicular to plane  $FAB$ .
- 3)  $\overline{ET}$  is perpendicular to plane  $CAD$ .
- 4)  $\overline{ET}$  is perpendicular to plane  $BAT$ .

- 16 Which set of numbers could *not* represent the lengths of the sides of a right triangle?

- 1)  $\{1, 3, \sqrt{10}\}$
- 2)  $\{2, 3, 4\}$
- 3)  $\{3, 4, 5\}$
- 4)  $\{8, 15, 17\}$

- 17 How many points are 5 units from a line and also equidistant from two points on the line?

- 1) 1
- 2) 2
- 3) 3
- 4) 0

- 18 The equation of a circle is  $(x - 2)^2 + (y + 5)^2 = 32$ . What are the coordinates of the center of this circle and the length of its radius?

- 1)  $(-2, 5)$  and 16
- 2)  $(2, -5)$  and 16
- 3)  $(-2, 5)$  and  $4\sqrt{2}$
- 4)  $(2, -5)$  and  $4\sqrt{2}$

- 19 The equation of a line is  $y = \frac{2}{3}x + 5$ . What is an equation of the line that is perpendicular to the given line and that passes through the point  $(4, 2)$ ?

- 1)  $y = \frac{2}{3}x - \frac{2}{3}$
- 2)  $y = \frac{3}{2}x - 4$
- 3)  $y = -\frac{3}{2}x + 7$
- 4)  $y = -\frac{3}{2}x + 8$

- 20 Consider the relationship between the two statements below.

If  $\sqrt{16 + 9} \neq 4 + 3$ , then  $5 \neq 4 + 3$

If  $\sqrt{16 + 9} = 4 + 3$ , then  $5 = 4 + 3$

These statements are

- 1) inverses
  - 2) converses
  - 3) contrapositives
  - 4) biconditionals
- 21 In the diagram of trapezoid  $ABCD$  below,  $\overline{AB} \parallel \overline{DC}$ ,  $\overline{AD} \cong \overline{BC}$ ,  $m\angle A = 4x + 20$ , and  $m\angle C = 3x - 15$ .

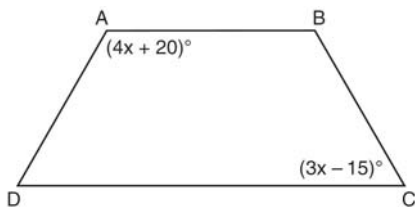

What is  $m\angle D$ ?

- 1) 25
- 2) 35
- 3) 60
- 4) 90

- 22 In circle  $R$  shown below, diameter  $\overline{DE}$  is perpendicular to chord  $\overline{ST}$  at point  $L$ .

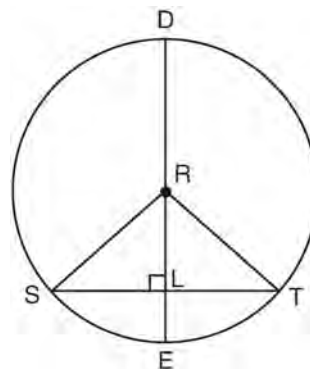

Which statement is *not* always true?

- 1)  $\overline{SL} \cong \overline{TL}$
  - 2)  $\overline{RS} = \overline{DR}$
  - 3)  $\overline{RL} \cong \overline{LE}$
  - 4)  $(DL)(LE) = (SL)(LT)$
- 23 Which equation represents circle  $A$  shown in the diagram below?

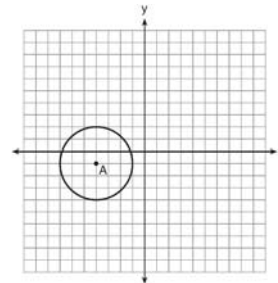

- 1)  $(x - 4)^2 + (y - 1)^2 = 3$
- 2)  $(x + 4)^2 + (y + 1)^2 = 3$
- 3)  $(x - 4)^2 + (y - 1)^2 = 9$
- 4)  $(x + 4)^2 + (y + 1)^2 = 9$



24 Which equation represents a line that is parallel to the line whose equation is  $3x - 2y = 7$ ?

- 1)  $y = -\frac{3}{2}x + 5$
- 2)  $y = -\frac{2}{3}x + 4$
- 3)  $y = \frac{3}{2}x - 5$
- 4)  $y = \frac{2}{3}x - 4$

25 In the diagram below of circle  $O$ ,  $\overline{PAC}$  and  $\overline{PBD}$  are secants.

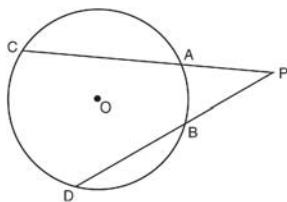

If  $m\widehat{CD} = 70$  and  $m\widehat{AB} = 20$ , what is the degree measure of  $\angle P$ ?

- 1) 25
- 2) 35
- 3) 45
- 4) 50

26 The measure of an interior angle of a regular polygon is  $120^\circ$ . How many sides does the polygon have?

- 1) 5
- 2) 6
- 3) 3
- 4) 4

27 As shown in the diagram of rectangle  $ABCD$  below, diagonals  $\overline{AC}$  and  $\overline{BD}$  intersect at  $E$ .

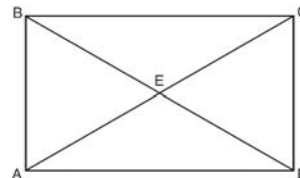

If  $AE = x + 2$  and  $BD = 4x - 16$ , then the length of  $\overline{AC}$  is

- 1) 6
- 2) 10
- 3) 12
- 4) 24

28 If the vertices of  $\triangle ABC$  are  $A(-2, 4)$ ,  $B(-2, 8)$ , and  $C(-5, 6)$ , then  $\triangle ABC$  is classified as

- 1) right
- 2) scalene
- 3) isosceles
- 4) equilateral

29 After the transformation  $r_{y=x}$  the image of  $\triangle ABC$  is  $\triangle A'B'C'$ . If  $AB = 2x + 13$  and  $A'B' = 9x - 8$ , find the value of  $x$ .

30 In the diagram below, circles  $A$  and  $B$  are tangent at point  $C$  and  $\overline{AB}$  is drawn. Sketch all common tangent lines.

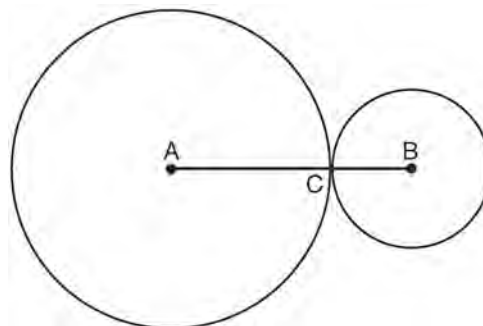

- 31 On the set of axes below, graph the locus of points 4 units from  $(0, 1)$  and the locus of points 3 units from the origin. Label with an **X** any points that satisfy *both* conditions.

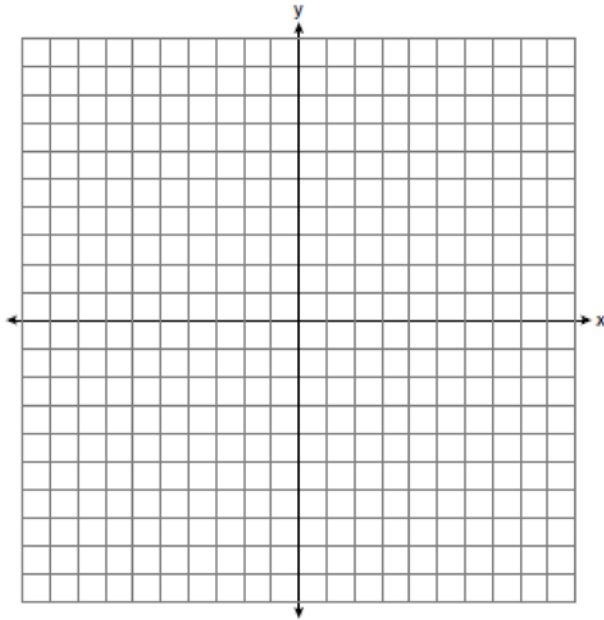

- 32 Write an equation of a circle whose center is  $(-3, 2)$  and whose diameter is 10.

- 33 Using a compass and straightedge, construct a line perpendicular to line  $\ell$  through point  $P$ . [Leave all construction marks.]

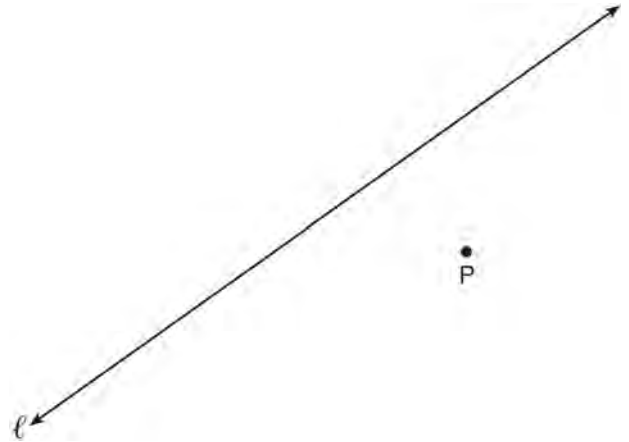

- 34 Write an equation of the line that is the perpendicular bisector of the line segment having endpoints  $(3, -1)$  and  $(3, 5)$ . [The use of the grid below is optional]

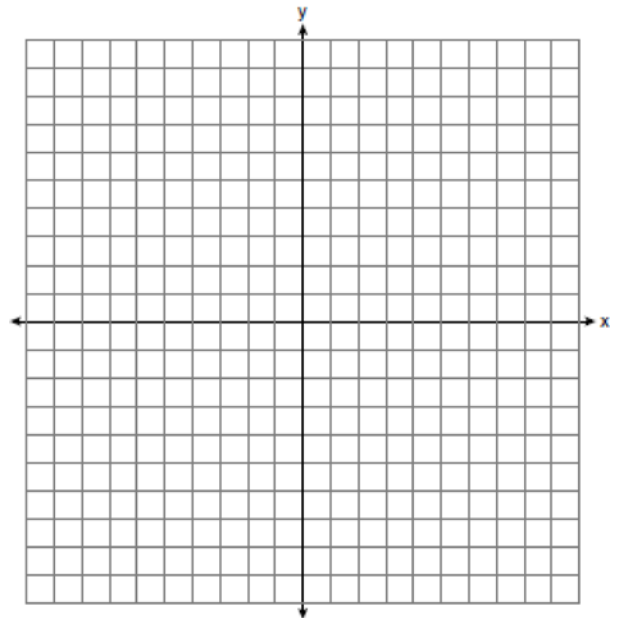

35 A right circular cylinder with a height of 5 cm has a base with a diameter of 6 cm. Find the lateral area of the cylinder to the *nearest hundredth of a square centimeter*. Find the volume of the cylinder to the *nearest hundredth of a cubic centimeter*.

36 Triangle  $ABC$  has vertices  $A(5, 1)$ ,  $B(1, 4)$  and  $C(1, 1)$ . State and label the coordinates of the vertices of  $\triangle A''B''C''$ , the image of  $\triangle ABC$ , following the composite transformation  $T_{1,-1} \circ D_2$ .  
[The use of the set of axes below is optional.]

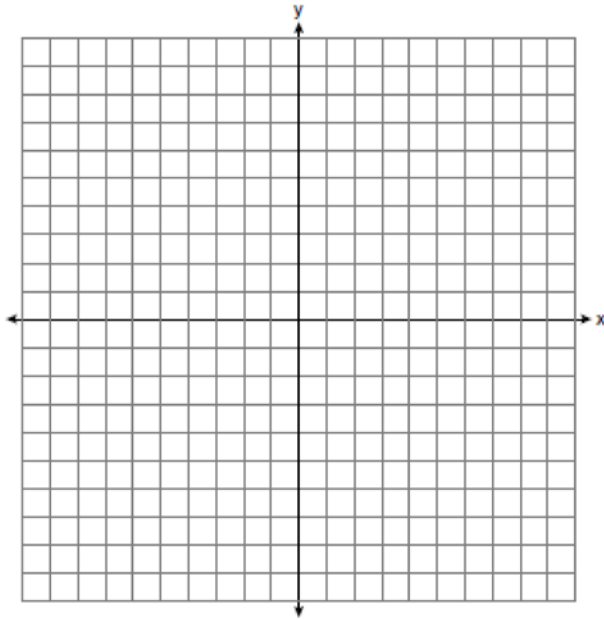

37 In  $\triangle ABC$ ,  $m\angle A = x^2 + 12$ ,  $m\angle B = 11x + 5$ , and  $m\angle C = 13x - 17$ . Determine the longest side of  $\triangle ABC$ .

38 The diagram below shows rectangle  $ABCD$  with points  $E$  and  $F$  on side  $\overline{AB}$ . Segments  $\overline{CE}$  and  $\overline{DF}$  intersect at  $G$ , and  $\angle ADG \cong \angle BCG$ . Prove:  
 $\overline{AE} \cong \overline{BF}$

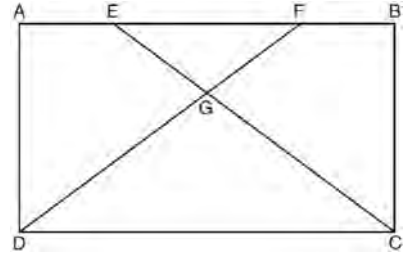

0613ge

- 1 In trapezoid  $RSTV$  with bases  $\overline{RS}$  and  $\overline{VT}$ , diagonals  $\overline{RT}$  and  $\overline{SV}$  intersect at  $Q$ .

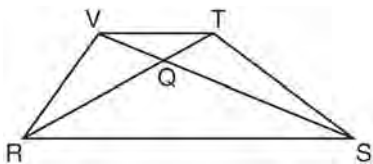

If trapezoid  $RSTV$  is *not* isosceles, which triangle is equal in area to  $\triangle RSV$ ?

- 1)  $\triangle RQV$
  - 2)  $\triangle RST$
  - 3)  $\triangle RVT$
  - 4)  $\triangle SVT$
- 2 In the diagram below,  $\triangle XYV \cong \triangle TSV$ .

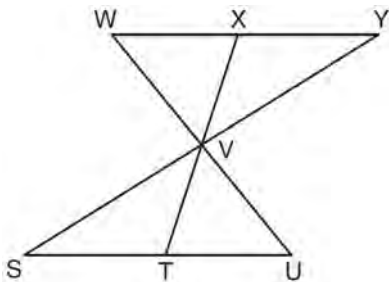

Which statement can *not* be proven?

- 1)  $\angle XVY \cong \angle TVS$
- 2)  $\angle VYX \cong \angle VUT$
- 3)  $\overline{XY} \cong \overline{TS}$
- 4)  $\overline{YV} \cong \overline{SV}$

- 3 In a park, two straight paths intersect. The city wants to install lampposts that are both equidistant from each path and also 15 feet from the intersection of the paths. How many lampposts are needed?

- 1) 1
- 2) 2
- 3) 3
- 4) 4

- 4 What are the coordinates of  $A'$ , the image of  $A(-3, 4)$ , after a rotation of  $180^\circ$  about the origin?

- 1)  $(4, -3)$
- 2)  $(-4, -3)$
- 3)  $(3, 4)$
- 4)  $(3, -4)$

- 5 Based on the construction below, which conclusion is *not* always true?

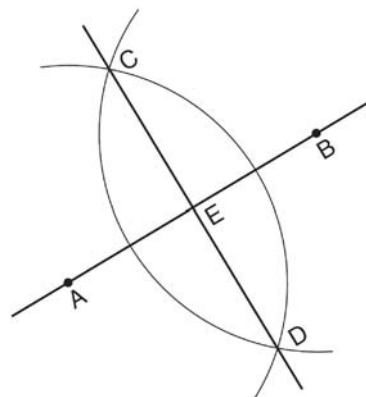

- 1)  $\overline{AB} \perp \overline{CD}$
- 2)  $AB = CD$
- 3)  $AE = EB$
- 4)  $CE = DE$

6 Which equation represents the circle whose center is  $(-5, 3)$  and that passes through the point  $(-1, 3)$ ?

- 1)  $(x + 1)^2 + (y - 3)^2 = 16$
- 2)  $(x - 1)^2 + (y + 3)^2 = 16$
- 3)  $(x + 5)^2 + (y - 3)^2 = 16$
- 4)  $(x - 5)^2 + (y + 3)^2 = 16$

7 As shown in the diagram below, when right triangle  $DAB$  is reflected over the  $x$ -axis, its image is triangle  $DCB$ .

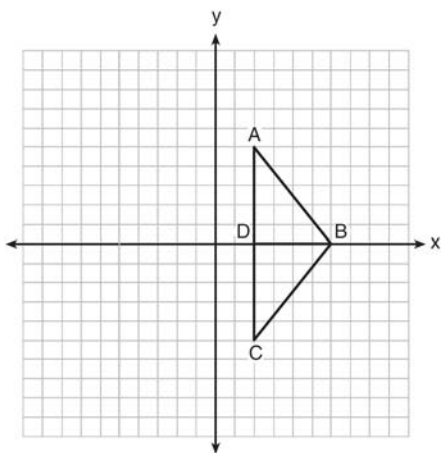

Which statement justifies why  $\overline{AB} \cong \overline{CB}$ ?

- 1) Distance is preserved under reflection.
- 2) Orientation is preserved under reflection.
- 3) Points on the line of reflection remain invariant.
- 4) Right angles remain congruent under reflection.

8 In  $\triangle ABC$ ,  $m\angle A = 3x + 1$ ,  $m\angle B = 4x - 17$ , and  $m\angle C = 5x - 20$ . Which type of triangle is  $\triangle ABC$ ?

- 1) right
- 2) scalene
- 3) isosceles
- 4) equilateral

9 What is the equation for circle  $O$  shown in the graph below?

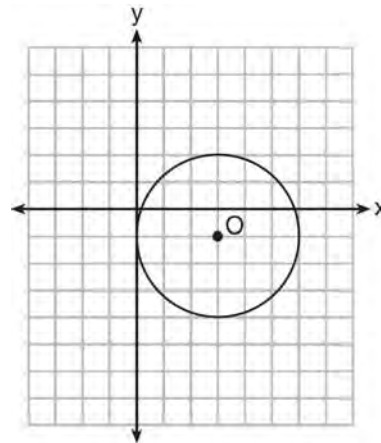

- 1)  $(x - 3)^2 + (y + 1)^2 = 6$
- 2)  $(x + 3)^2 + (y - 1)^2 = 6$
- 3)  $(x - 3)^2 + (y + 1)^2 = 9$
- 4)  $(x + 3)^2 + (y - 1)^2 = 9$

10 Point  $A$  is on line  $m$ . How many distinct planes will be perpendicular to line  $m$  and pass through point  $A$ ?

- 1) one
- 2) two
- 3) zero
- 4) infinite

- 11 In  $\triangle ABC$ ,  $D$  is the midpoint of  $\overline{AB}$  and  $E$  is the midpoint of  $\overline{BC}$ . If  $AC = 3x - 15$  and  $DE = 6$ , what is the value of  $x$ ?

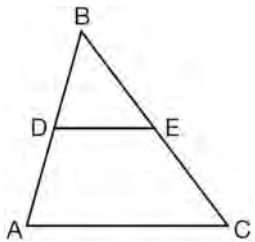

- 1) 6  
 2) 7  
 3) 9  
 4) 12
- 12 What are the coordinates of the center of a circle if the endpoints of its diameter are  $A(8, -4)$  and  $B(-3, 2)$ ?
- 1)  $(2.5, 1)$   
 2)  $(2.5, -1)$   
 3)  $(5.5, -3)$   
 4)  $(5.5, 3)$

- 13 Which graph could be used to find the solution to the following system of equations?

$$y = (x + 3)^2 - 1$$

$$x + y = 2$$

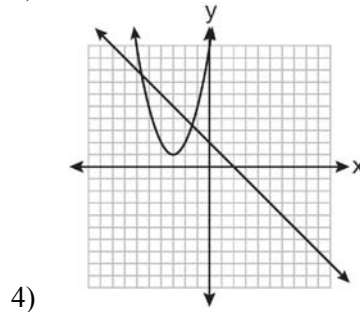
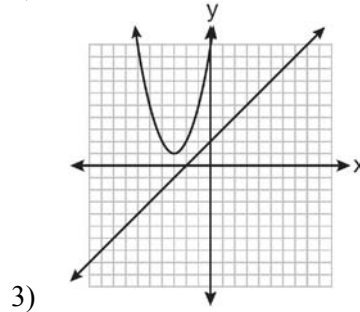
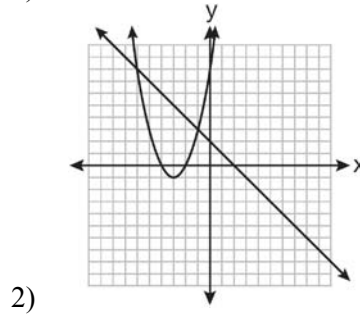
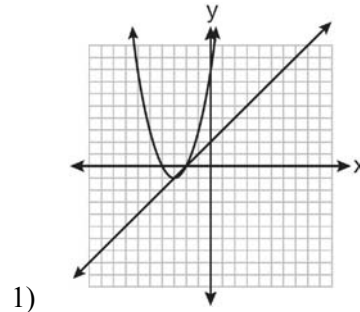

- 14 What is the converse of “If an angle measures 90 degrees, then it is a right angle”?
- 1) If an angle is a right angle, then it measures 90 degrees.
  - 2) An angle is a right angle if it measures 90 degrees.
  - 3) If an angle is not a right angle, then it does not measure 90 degrees.
  - 4) If an angle does not measure 90 degrees, then it is not a right angle.

- 15 As shown in the diagram below, a right pyramid has a square base,  $ABCD$ , and  $EF$  is the slant height.

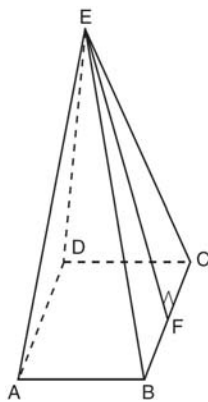

Which statement is *not* true?

- 1)  $\overline{EA} \cong \overline{EC}$
- 2)  $\overline{EB} \cong \overline{EF}$
- 3)  $\triangle AEB \cong \triangle BEC$
- 4)  $\triangle CED$  is isosceles

- 16 What is the equation of a line passing through the point  $(6, 1)$  and parallel to the line whose equation is  $3x = 2y + 4$ ?
- 1)  $y = -\frac{2}{3}x + 5$
  - 2)  $y = -\frac{2}{3}x - 3$
  - 3)  $y = \frac{3}{2}x - 8$
  - 4)  $y = \frac{3}{2}x - 5$

- 17 The volume of a sphere is approximately 44.6022 cubic centimeters. What is the radius of the sphere, to the *nearest tenth of a centimeter*?
- 1) 2.2
  - 2) 3.3
  - 3) 4.4
  - 4) 4.7

- 18 Points  $A(5, 3)$  and  $B(7, 6)$  lie on  $\overleftrightarrow{AB}$ . Points  $C(6, 4)$  and  $D(9, 0)$  lie on  $\overleftrightarrow{CD}$ . Which statement is true?
- 1)  $\overleftrightarrow{AB} \parallel \overleftrightarrow{CD}$
  - 2)  $\overleftrightarrow{AB} \perp \overleftrightarrow{CD}$
  - 3)  $\overleftrightarrow{AB}$  and  $\overleftrightarrow{CD}$  are the same line.
  - 4)  $\overleftrightarrow{AB}$  and  $\overleftrightarrow{CD}$  intersect, but are not perpendicular.

19 Which set of equations represents two circles that have the same center?

- 1)  $x^2 + (y + 4)^2 = 16$  and  $(x + 4)^2 + y^2 = 16$
- 2)  $(x + 3)^2 + (y - 3)^2 = 16$  and  $(x - 3)^2 + (y + 3)^2 = 25$
- 3)  $(x - 7)^2 + (y - 2)^2 = 16$  and  $(x + 7)^2 + (y + 2)^2 = 25$
- 4)  $(x - 2)^2 + (y - 5)^2 = 16$  and  $(x - 2)^2 + (y - 5)^2 = 25$

20 Transversal  $\overleftrightarrow{EF}$  intersects  $\overleftrightarrow{AB}$  and  $\overleftrightarrow{CD}$ , as shown in the diagram below.

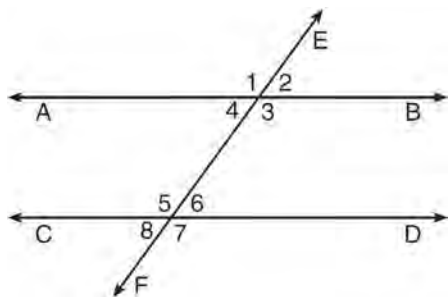

Which statement could always be used to prove

$\overleftrightarrow{AB} \parallel \overleftrightarrow{CD}$ ?

- 1)  $\angle 2 \cong \angle 4$
- 2)  $\angle 7 \cong \angle 8$
- 3)  $\angle 3$  and  $\angle 6$  are supplementary
- 4)  $\angle 1$  and  $\angle 5$  are supplementary

21 In  $\triangle ABC$ ,  $m\angle A = 60$ ,  $m\angle B = 80$ , and  $m\angle C = 40$ .

Which inequality is true?

- 1)  $AB > BC$
- 2)  $AC > BC$
- 3)  $AC < BA$
- 4)  $BC < BA$

22 Circle  $O$  with  $\angle AOC$  and  $\angle ABC$  is shown in the diagram below.

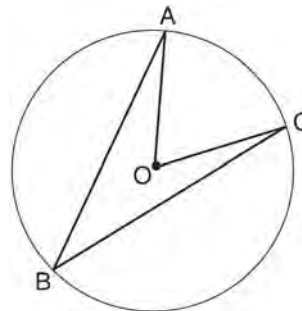

What is the ratio of  $m\angle AOC$  to  $m\angle ABC$ ?

- 1) 1 : 1
- 2) 2 : 1
- 3) 3 : 1
- 4) 1 : 2

23 A rectangular prism has a base with a length of 25, a width of 9, and a height of 12. A second prism has a square base with a side of 15. If the volumes of the two prisms are equal, what is the height of the second prism?

- 1) 6
- 2) 8
- 3) 12
- 4) 15

24 In triangles  $ABC$  and  $DEF$ ,  $AB = 4$ ,  $AC = 5$ ,  $DE = 8$ ,  $DF = 10$ , and  $\angle A \cong \angle D$ . Which method could be used to prove  $\triangle ABC \sim \triangle DEF$ ?

- 1) AA
- 2) SAS
- 3) SSS
- 4) ASA



- 25 Which graph represents a circle whose equation is  $x^2 + (y - 1)^2 = 9$ ?

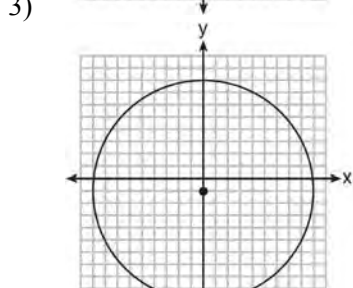
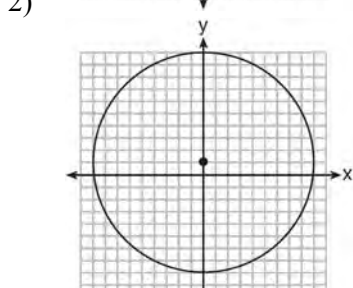
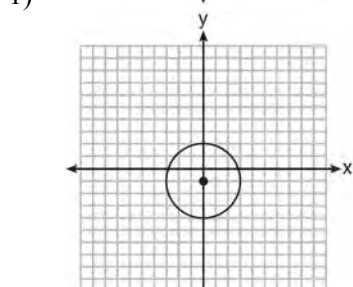
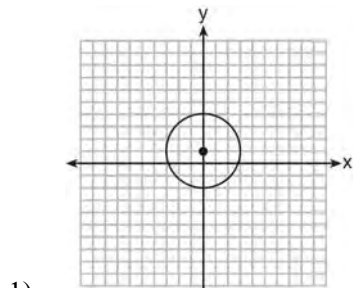

- 26 What is the perimeter of a rhombus whose diagonals are 16 and 30?

- 1) 92
- 2) 68
- 3) 60
- 4) 17

- 27 In right triangle  $ABC$  shown in the diagram below, altitude  $BD$  is drawn to hypotenuse  $AC$ ,  $CD = 12$ , and  $AD = 3$ .

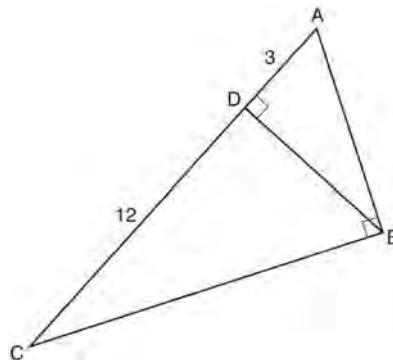

What is the length of  $\overline{AB}$ ?

- 1)  $5\sqrt{3}$
- 2) 6
- 3)  $3\sqrt{5}$
- 4) 9

- 28 Secants  $\overline{JKL}$  and  $\overline{JMN}$  are drawn to circle  $O$  from an external point,  $J$ . If  $JK = 8$ ,  $LK = 4$ , and  $JM = 6$ , what is the length of  $\overline{JN}$ ?

- 1) 16
- 2) 12
- 3) 10
- 4) 8

- 29 A right circular cylinder has a height of 7 inches and the base has a diameter of 6 inches. Determine the lateral area, in square inches, of the cylinder in terms of  $\pi$ .

- 30 Determine, in degrees, the measure of each interior angle of a regular octagon.

31 Triangle  $ABC$  has vertices at  $A(3, 0)$ ,  $B(9, -5)$ , and  $C(7, -8)$ . Find the length of  $\overline{AC}$  in simplest radical form.

32 On the ray drawn below, using a compass and straightedge, construct an equilateral triangle with a vertex at  $R$ . The length of a side of the triangle must be equal to a length of the diagonal of rectangle  $ABCD$ .

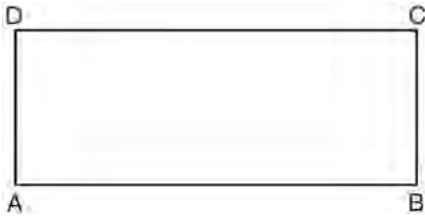

33 On the set of axes below, graph the locus of points 4 units from the  $x$ -axis and equidistant from the points whose coordinates are  $(-2, 0)$  and  $(8, 0)$ . Mark with an **X** all points that satisfy *both* conditions.

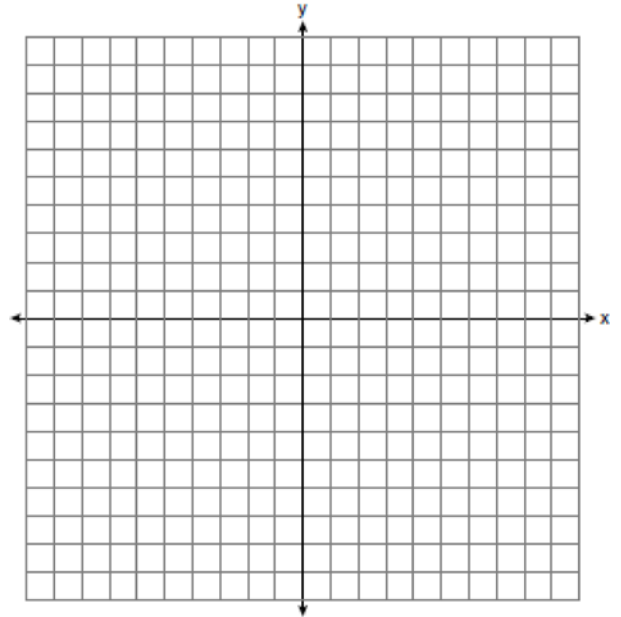

34 The coordinates of two vertices of square  $ABCD$  are  $A(2, 1)$  and  $B(4, 4)$ . Determine the slope of side  $\overline{BC}$ .

- 35 The coordinates of the vertices of parallelogram  $SWAN$  are  $S(2, -2)$ ,  $W(-2, -4)$ ,  $A(-4, 6)$ , and  $N(0, 8)$ . State and label the coordinates of parallelogram  $S''W''A''N''$ , the image of  $SWAN$  after the transformation  $T_{4, -2} \circ D_{\frac{1}{2}}$ . [The use of the set of axes below is optional.]

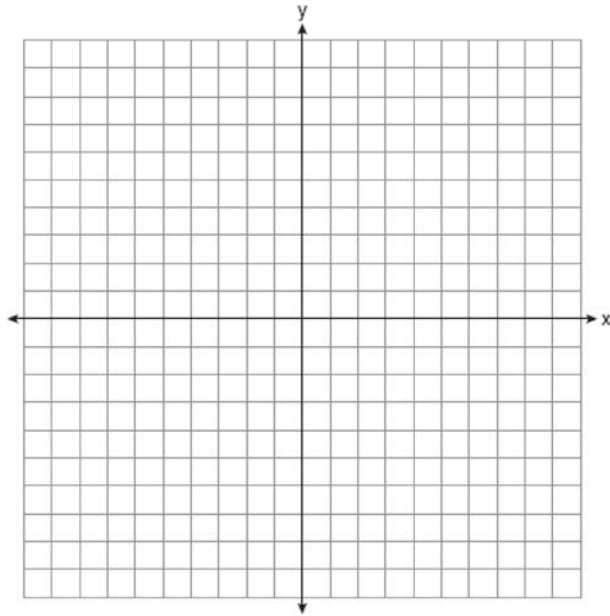

- 36 In circle  $O$  shown below, chords  $\overline{AB}$  and  $\overline{CD}$  and radius  $\overline{OA}$  are drawn, such that  $\overline{AB} \cong \overline{CD}$ ,  $\overline{OE} \perp \overline{AB}$ ,  $\overline{OF} \perp \overline{CD}$ ,  $OF = 16$ ,  $CF = y + 10$ , and  $CD = 4y - 20$ .

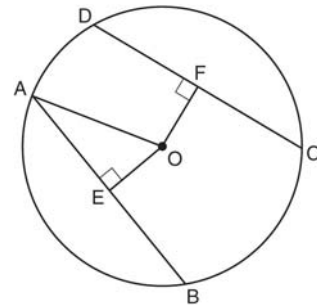

Determine the length of  $\overline{DF}$ . Determine the length of  $\overline{OA}$ .

- 37 If  $\triangle RST \sim \triangle ABC$ ,  $m\angle A = x^2 - 8x$ ,  $m\angle C = 4x - 5$ , and  $m\angle R = 5x + 30$ , find  $m\angle C$ . [Only an algebraic solution can receive full credit.]

- 38 In the diagram of  $\triangle MAH$  below,  $\overline{MH} \cong \overline{AH}$  and medians  $\overline{AB}$  and  $\overline{MT}$  are drawn. Prove:  $\angle MBA \cong \angle ATM$

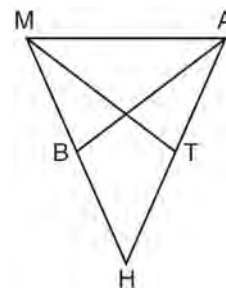

0813ge

- 1 Given:  $\triangle ABD$ ,  $\overline{BC}$  is the perpendicular bisector of  $\overline{AD}$

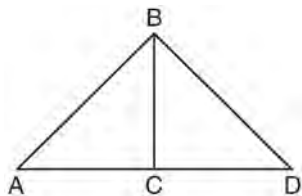

Which statement can *not* always be proven?

- 1)  $\overline{AC} \cong \overline{DC}$
  - 2)  $\overline{BC} \cong \overline{CD}$
  - 3)  $\angle ACB \cong \angle DCB$
  - 4)  $\triangle ABC \cong \triangle DBC$
- 2 In the diagram of circle  $O$  below, chord  $\overline{CD}$  is parallel to diameter  $\overline{AOB}$  and  $m\widehat{CD} = 110$ .

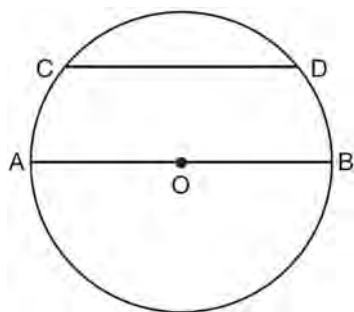

What is  $m\widehat{DB}$ ?

- 1) 35
  - 2) 55
  - 3) 70
  - 4) 110
- 3 Given the statement: One is a prime number. What is the negation and the truth value of the negation?
- 1) One is not a prime number; true
  - 2) One is not a prime number; false
  - 3) One is a composite number; true
  - 4) One is a composite number; false

- 4 Triangle  $ABC$  has the coordinates  $A(1,2)$ ,  $B(5,2)$ , and  $C(5,5)$ . Triangle  $ABC$  is rotated  $180^\circ$  about the origin to form triangle  $A'B'C'$ . Triangle  $A'B'C'$  is
- 1) acute
  - 2) isosceles
  - 3) obtuse
  - 4) right

- 5 What is an equation of the circle with center  $(-5,4)$  and a radius of 7?

- 1)  $(x - 5)^2 + (y + 4)^2 = 14$
- 2)  $(x - 5)^2 + (y + 4)^2 = 49$
- 3)  $(x + 5)^2 + (y - 4)^2 = 14$
- 4)  $(x + 5)^2 + (y - 4)^2 = 49$

- 6 In  $\triangle ABC$ ,  $\angle A \cong \angle B$  and  $\angle C$  is an obtuse angle. Which statement is true?

- 1)  $\overline{AC} \cong \overline{AB}$  and  $\overline{BC}$  is the longest side.
- 2)  $\overline{AC} \cong \overline{BC}$  and  $\overline{AB}$  is the longest side.
- 3)  $\overline{AC} \cong \overline{AB}$  and  $\overline{BC}$  is the shortest side.
- 4)  $\overline{AC} \cong \overline{BC}$  and  $\overline{AB}$  is the shortest side.

- 7 In the diagram of  $\triangle ABC$  below, medians  $\overline{AD}$  and  $\overline{BE}$  intersect at point  $F$ .

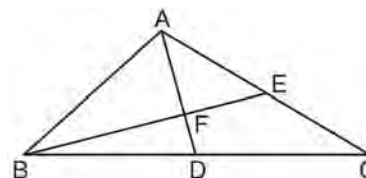

If  $AF = 6$ , what is the length of  $\overline{FD}$ ?

- 1) 6
  - 2) 2
  - 3) 3
  - 4) 9
- 8 In circle  $O$ , diameter  $\overline{AB}$  intersects chord  $\overline{CD}$  at  $E$ . If  $CE = ED$ , then  $\angle CEA$  is which type of angle?
- 1) straight
  - 2) obtuse
  - 3) acute
  - 4) right

9 If  $\triangle ABC \cong \triangle JKL \cong \triangle RST$ , then  $\overline{BC}$  must be congruent to

- 1)  $\overline{JL}$
- 2)  $\overline{JK}$
- 3)  $\overline{ST}$
- 4)  $\overline{RS}$

10 In the diagram of  $\triangle ABC$  below,  $\overline{AB}$  is extended to point  $D$ .

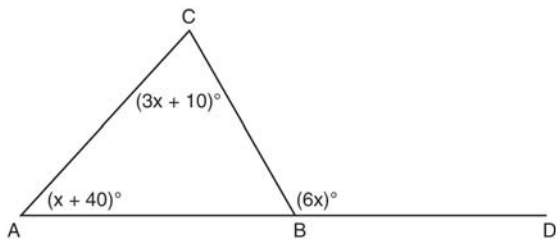

If  $m\angle CAB = x + 40$ ,  $m\angle ACB = 3x + 10$ ,  $m\angle CBD = 6x$ , what is  $m\angle CAB$ ?

- 1) 13
- 2) 25
- 3) 53
- 4) 65

11 The bases of a right triangular prism are  $\triangle ABC$  and  $\triangle DEF$ . Angles  $A$  and  $D$  are right angles,  $AB = 6$ ,  $AC = 8$ , and  $AD = 12$ . What is the length of edge  $\overline{BE}$ ?

- 1) 10
- 2) 12
- 3) 14
- 4) 16

12 What is the equation of circle  $O$  shown in the diagram below?

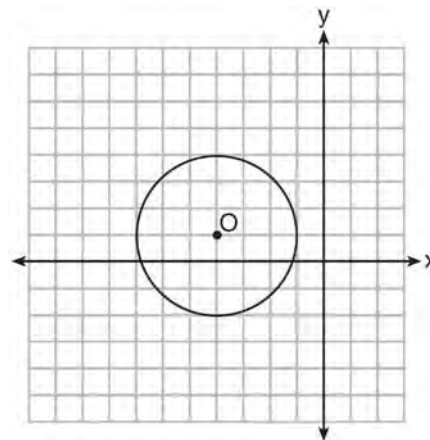

- 1)  $(x + 4)^2 + (y - 1)^2 = 3$
- 2)  $(x - 4)^2 + (y + 1)^2 = 3$
- 3)  $(x + 4)^2 + (y - 1)^2 = 9$
- 4)  $(x - 4)^2 + (y + 1)^2 = 9$

13 The diagram below shows the construction of line  $m$ , parallel to line  $\ell$ , through point  $P$ .

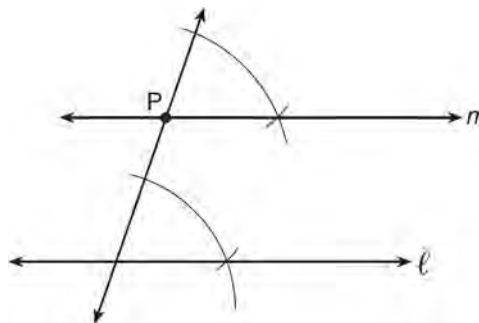

Which theorem was used to justify this construction?

- 1) If two lines are cut by a transversal and the alternate interior angles are congruent, the lines are parallel.
- 2) If two lines are cut by a transversal and the interior angles on the same side are supplementary, the lines are parallel.
- 3) If two lines are perpendicular to the same line, they are parallel.
- 4) If two lines are cut by a transversal and the corresponding angles are congruent, they are parallel.

- 14 The lateral area of a right circular cone is equal to  $120\pi \text{ cm}^2$ . If the base of the cone has a diameter of 24 cm, what is the length of the slant height, in centimeters?
- 1) 2.5
  - 2) 5
  - 3) 10
  - 4) 15.7

- 15 A student wrote the following equations:

$$3y + 6 = 2x$$

$$2y - 3x = 6$$

The lines represented by these equations are

- 1) parallel
  - 2) the same line
  - 3) perpendicular
  - 4) intersecting, but *not* perpendicular
- 16 In a coordinate plane, the locus of points 5 units from the  $x$ -axis is the
- 1) lines  $x = 5$  and  $x = -5$
  - 2) lines  $y = 5$  and  $y = -5$
  - 3) line  $x = 5$ , only
  - 4) line  $y = 5$ , only

- 17 The sides of a triangle are 8, 12, and 15. The longest side of a similar triangle is 18. What is the ratio of the perimeter of the smaller triangle to the perimeter of the larger triangle?
- 1) 2:3
  - 2) 4:9
  - 3) 5:6
  - 4) 25:36

- 18 Lines  $m$  and  $n$  are in plane  $\mathcal{A}$ . What is the converse of the statement “If lines  $m$  and  $n$  are parallel, then lines  $m$  and  $n$  do not intersect”?
- 1) If lines  $m$  and  $n$  are not parallel, then lines  $m$  and  $n$  intersect.
  - 2) If lines  $m$  and  $n$  are not parallel, then lines  $m$  and  $n$  do not intersect
  - 3) If lines  $m$  and  $n$  intersect, then lines  $m$  and  $n$  are not parallel.
  - 4) If lines  $m$  and  $n$  do not intersect, then lines  $m$  and  $n$  are parallel.

- 19 When the system of equations  $y + 2 = (x - 4)^2$  and  $2x + y - 6 = 0$  is solved graphically, the solution is
- 1)  $(-4, -2)$  and  $(-2, 2)$
  - 2)  $(4, -2)$  and  $(2, 2)$
  - 3)  $(-4, 2)$  and  $(-6, 6)$
  - 4)  $(4, 2)$  and  $(6, 6)$
- 20 In the diagram of  $\triangle UVW$  below,  $A$  is the midpoint of  $\overline{UV}$ ,  $B$  is the midpoint of  $\overline{UW}$ ,  $C$  is the midpoint of  $\overline{VW}$ , and  $\overline{AB}$  and  $\overline{AC}$  are drawn.

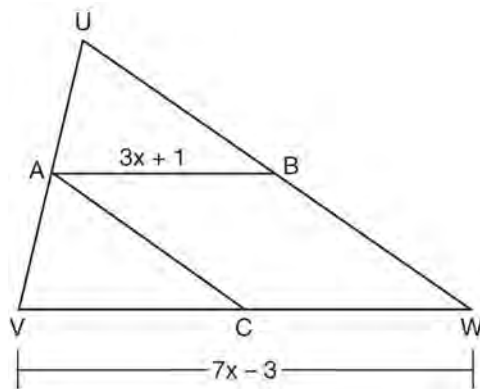

If  $\overline{VW} = 7x - 3$  and  $\overline{AB} = 3x + 1$ , what is the length of  $\overline{VC}$ ?

- 1) 5
  - 2) 13
  - 3) 16
  - 4) 32
- 21 Two prisms have equal heights and equal volumes. The base of one is a pentagon and the base of the other is a square. If the area of the pentagonal base is 36 square inches, how many inches are in the length of each side of the square base?
- 1) 6
  - 2) 9
  - 3) 24
  - 4) 36
- 22 What is the difference between the sum of the measures of the interior angles of a regular pentagon and the sum of the measures of the exterior angles of a regular pentagon?
- 1) 36
  - 2) 72
  - 3) 108
  - 4) 180

- 23 If line  $\ell$  is perpendicular to distinct planes  $\mathcal{P}$  and  $\mathcal{Q}$ , then planes  $\mathcal{P}$  and  $\mathcal{Q}$
- 1) are parallel
  - 2) contain line  $\ell$
  - 3) are perpendicular
  - 4) intersect, but are *not* perpendicular
- 24 Which graph represents a circle whose equation is  $x^2 + (y - 2)^2 = 4$ ?

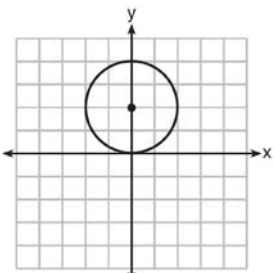
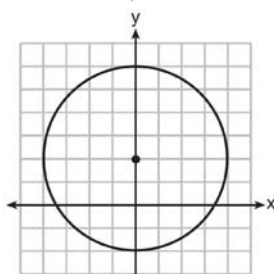
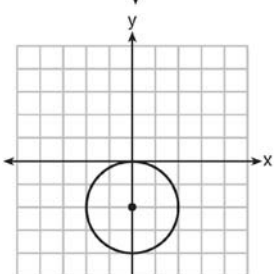
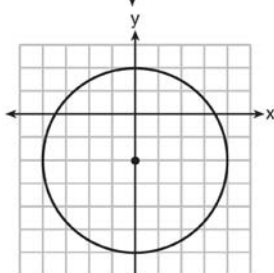
- 1) 
- 2) 
- 3) 
- 4) 

- 25 In the diagram below,  $\overline{AC}$  and  $\overline{AD}$  are tangent to circle  $B$  at points  $C$  and  $D$ , respectively, and  $\overline{BC}$ ,  $\overline{BD}$ , and  $\overline{BA}$  are drawn.

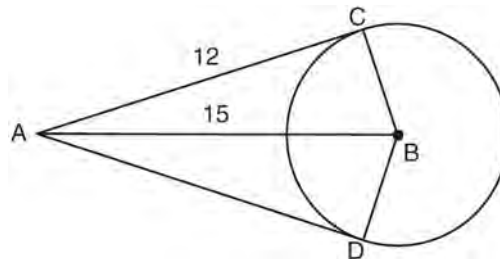

If  $AC = 12$  and  $AB = 15$ , what is the length of  $\overline{BD}$ ?

- 1) 5.5
  - 2) 9
  - 3) 12
  - 4) 18
- 26 Triangle  $ABC$  shown below is a right triangle with altitude  $\overline{AD}$  drawn to the hypotenuse  $\overline{BC}$ .

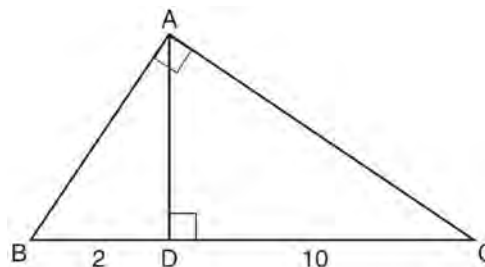

If  $BD = 2$  and  $DC = 10$ , what is the length of  $\overline{AB}$ ?

- 1)  $2\sqrt{2}$
  - 2)  $2\sqrt{5}$
  - 3)  $2\sqrt{6}$
  - 4)  $2\sqrt{30}$
- 27 Triangle  $ABC$  has vertices  $A(0, 0)$ ,  $B(6, 8)$ , and  $C(8, 4)$ . Which equation represents the perpendicular bisector of  $\overline{BC}$ ?
- 1)  $y = 2x - 6$
  - 2)  $y = -2x + 4$
  - 3)  $y = \frac{1}{2}x + \frac{5}{2}$
  - 4)  $y = -\frac{1}{2}x + \frac{19}{2}$

28 Chords  $\overline{AB}$  and  $\overline{CD}$  intersect at point  $E$  in a circle with center at  $O$ . If  $\overline{AE} = 8$ ,  $AB = 20$ , and  $DE = 16$ , what is the length of  $\overline{CE}$ ?

- 1) 6
- 2) 9
- 3) 10
- 4) 12

29 Triangle  $ABC$  has vertices  $A(6, 6)$ ,  $B(9, 0)$ , and  $C(3, -3)$ . State and label the coordinates of  $\triangle A'B'C'$ , the image of  $\triangle ABC$  after a dilation of  $D_{\frac{1}{3}}$ .

30 Using a compass and straightedge, construct the bisector of  $\angle MJH$ . [Leave all construction marks.]

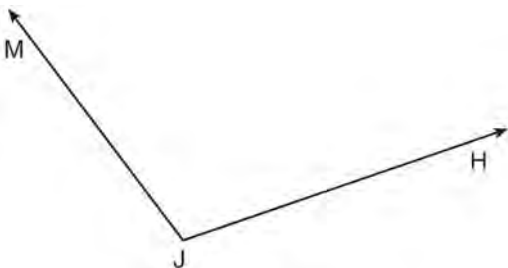

31 Find, in simplest radical form, the length of the line segment with endpoints whose coordinates are  $(-1, 4)$  and  $(3, -2)$ .

32 In  $\triangle ABC$ , the measure of angle  $A$  is fifteen less than twice the measure of angle  $B$ . The measure of angle  $C$  equals the sum of the measures of angle  $A$  and angle  $B$ . Determine the measure of angle  $B$ .

33 A circle has the equation  $(x - 3)^2 + (y + 4)^2 = 10$ . Find the coordinates of the center of the circle and the length of the circle's radius.

34 Two intersecting lines are shown in the diagram below. Sketch the locus of points that are equidistant from the two lines. Sketch the locus of points that are a given distance,  $d$ , from the point of intersection of the given lines. State the number of points that satisfy both conditions.

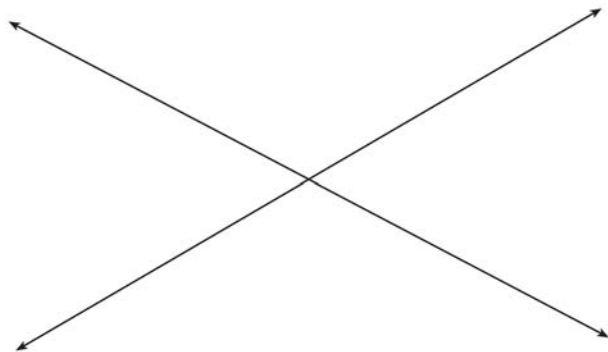

35 Given:  $\triangle ABC$ ,  $\overline{BD}$  bisects  $\angle ABC$ ,  $\overline{BD} \perp \overline{AC}$   
 Prove:  $\overline{AB} \cong \overline{CB}$

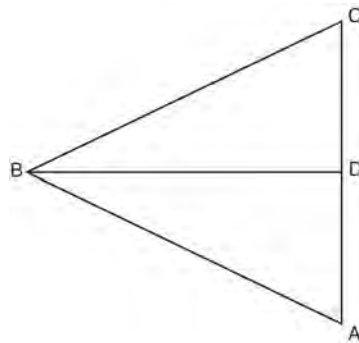



- 36 Quadrilateral  $MATH$  has coordinates  $M(-6, -3)$ ,  $A(-1, -3)$ ,  $T(-2, -1)$ , and  $H(-4, -1)$ . The image of quadrilateral  $MATH$  after the composition  $r_{x\text{-axis}} \circ T_{7,5}$  is quadrilateral  $M''A''T''H''$ . State and label the coordinates of  $M''A''T''H''$ . [The use of the set of axes below is optional.]

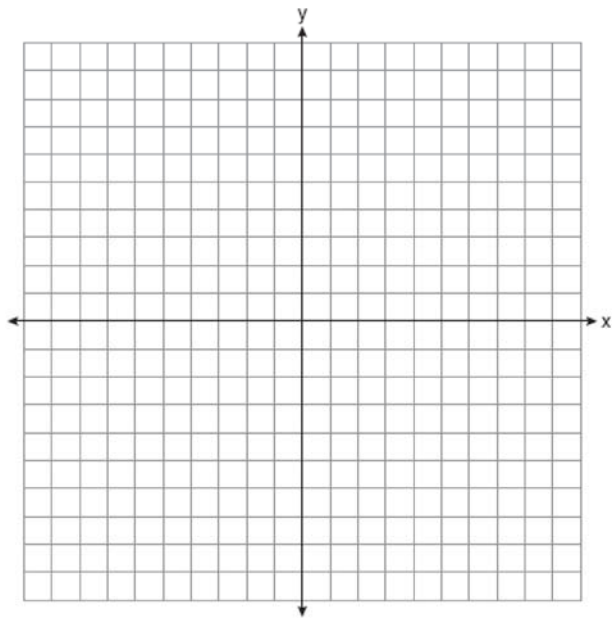

- 38 Quadrilateral  $ABCD$  with vertices  $A(-7, 4)$ ,  $B(-3, 6)$ ,  $C(3, 0)$ , and  $D(1, -8)$  is graphed on the set of axes below. Quadrilateral  $MNPQ$  is formed by joining  $M$ ,  $N$ ,  $P$ , and  $Q$ , the midpoints of  $\overline{AB}$ ,  $\overline{BC}$ ,  $\overline{CD}$ , and  $\overline{AD}$ , respectively. Prove that quadrilateral  $MNPQ$  is a parallelogram. Prove that quadrilateral  $MNPQ$  is *not* a rhombus.

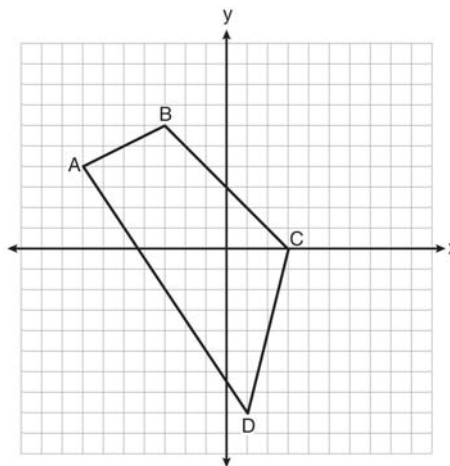

- 37 Trapezoid  $TRAP$ , with median  $\overline{MQ}$ , is shown in the diagram below. Solve algebraically for  $x$  and  $y$ .

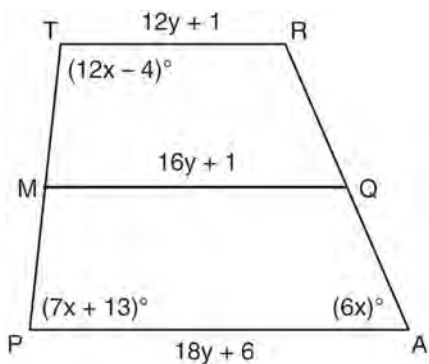

**fall08ge**  
**Answer Section**

1 ANS: 3

The diagonals of an isosceles trapezoid are congruent.  $5x + 3 = 11x - 5$ .

$$6x = 18$$

$$x = 3$$

PTS: 2 REF: fall0801ge STA: G.G.40 TOP: Trapezoids

2 ANS: 4 PTS: 2 REF: fall0802ge STA: G.G.24

TOP: Negations

3 ANS: 1

$(x,y) \rightarrow (x+3,y+1)$

PTS: 2 REF: fall0803ge STA: G.G.54 TOP: Translations

4 ANS: 3 PTS: 2 REF: fall0804ge STA: G.G.18

TOP: Constructions

5 ANS: 3

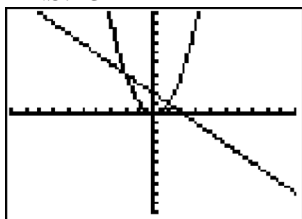

PTS: 2 REF: fall0805ge STA: G.G.70 TOP: Quadratic-Linear Systems

6 ANS: 2 PTS: 2 REF: fall0806ge STA: G.G.9

TOP: Planes

7 ANS: 1 PTS: 2 REF: fall0807ge STA: G.G.19

TOP: Constructions

8 ANS: 3

The lateral edges of a prism are parallel.

PTS: 2 REF: fall0808ge STA: G.G.10 TOP: Solids

9 ANS: 1

Since  $\overline{AC} \cong \overline{BC}$ ,  $m\angle A = m\angle B$  under the Isosceles Triangle Theorem.

PTS: 2 REF: fall0809ge STA: G.G.69 TOP: Triangles in the Coordinate Plane

10 ANS: 4

Median  $\overline{BF}$  bisects  $\overline{AC}$  so that  $\overline{CF} \cong \overline{FA}$ .

PTS: 2 REF: fall0810ge STA: G.G.24 TOP: Statements

11 ANS: 3

Because  $\overline{OC}$  is a radius, its length is 5. Since  $CE = 2OE = 3$ .  $\triangle EDO$  is a 3-4-5 triangle. If  $ED = 4$ ,  $BD = 8$ .

PTS: 2 REF: fall0811ge STA: G.G.49 TOP: Chords

12 ANS: 2

The slope of a line in standard form is  $-\frac{A}{B}$ , so the slope of this line is  $\frac{-2}{-1} = 2$ . A parallel line would also have a slope of 2. Since the answers are in slope intercept form, find the y-intercept:  $y = mx + b$

$$-11 = 2(-3) + b$$

$$-5 = b$$

PTS: 2 REF: fall0812ge STA: G.G.65 TOP: Parallel and Perpendicular Lines

13 ANS: 2

$$M_x = \frac{2+(-4)}{2} = -1. \quad M_y = \frac{-3+6}{2} = \frac{3}{2}.$$

PTS: 2 REF: fall0813ge STA: G.G.66 TOP: Midpoint

14 ANS: 3 PTS: 2 REF: fall0814ge STA: G.G.73

TOP: Equations of Circles

15 ANS: 1

$$3x^2 + 18x + 24$$

$$3(x^2 + 6x + 8)$$

$$3(x+4)(x+2)$$

PTS: 2 REF: fall0815ge STA: G.G.12 TOP: Volume

16 ANS: 3 PTS: 2 REF: fall0816ge STA: G.G.1

TOP: Planes

17 ANS: 2

$$x^2 = 3(x+18)$$

$$x^2 - 3x - 54 = 0$$

$$(x-9)(x+6) = 0$$

$$x = 9$$

PTS: 2 REF: fall0817ge STA: G.G.53 TOP: Segments Intercepted by Circle

KEY: tangent and secant

18 ANS: 4 PTS: 2 REF: fall0818ge STA: G.G.61

TOP: Analytical Representations of Transformations

19 ANS: 2

$$7+18 > 6+12$$

PTS: 2 REF: fall0819ge STA: G.G.33 TOP: Triangle Inequality Theorem

20 ANS: 1

$M_x = \frac{-2+6}{2} = 2$ .  $M_y = \frac{3+3}{2} = 3$ . The center is (2,3).  $d = \sqrt{(-2-6)^2 + (3-3)^2} = \sqrt{64+0} = 8$ . If the diameter is 8, the radius is 4 and  $r^2 = 16$ .

PTS: 2 REF: fall0820ge STA: G.G.71 TOP: Equations of Circles

21 ANS: 1

$\triangle PRT$  and  $\triangle SRQ$  share  $\angle R$  and it is given that  $\angle RPT \cong \angle RSQ$ .

PTS: 2 REF: fall0821ge STA: G.G.44 TOP: Similarity Proofs

22 ANS: 4

$$3y + 1 = 6x + 4. \quad 2y + 1 = x - 9$$

$$3y = 6x + 3 \quad 2y = x - 10$$

$$y = 2x + 1 \quad y = \frac{1}{2}x - 5$$

PTS: 2 REF: fall0822ge STA: G.G.63 TOP: Parallel and Perpendicular Lines

23 ANS: 1

After the translation, the coordinates are  $A'(-1,5)$  and  $B'(3,4)$ . After the dilation, the coordinates are  $A''(-2,10)$  and  $B''(6,8)$ .

PTS: 2 REF: fall0823ge STA: G.G.58 TOP: Compositions of Transformations

24 ANS: 4

PTS: 2 REF: fall0824ge STA: G.G.50

TOP: Tangents KEY: common tangency

25 ANS: 3

PTS: 2 REF: fall0825ge STA: G.G.21

TOP: Centroid, Orthocenter, Incenter and Circumcenter

26 ANS: 4

Corresponding angles of similar triangles are congruent.

PTS: 2 REF: fall0826ge STA: G.G.45 TOP: Similarity

KEY: perimeter and area

27 ANS: 4

$$(n-2)180 = (8-2)180 = 1080. \quad \frac{1080}{8} = 135.$$

PTS: 2 REF: fall0827ge STA: G.G.37 TOP: Interior and Exterior Angles of Polygons

28 ANS: 2

The slope of a line in standard form is  $-\frac{A}{B}$  so the slope of this line is  $-\frac{5}{3}$ . Perpendicular lines have slope that are the opposite and reciprocal of each other.

PTS: 2 REF: fall0828ge STA: G.G.62 TOP: Parallel and Perpendicular Lines

29 ANS:

$$2\sqrt{3}. \quad x^2 = 3 \cdot 4$$

$$x = \sqrt{12} = 2\sqrt{3}$$

PTS: 2 REF: fall0829ge STA: G.G.47 TOP: Similarity

KEY: altitude

30 ANS:

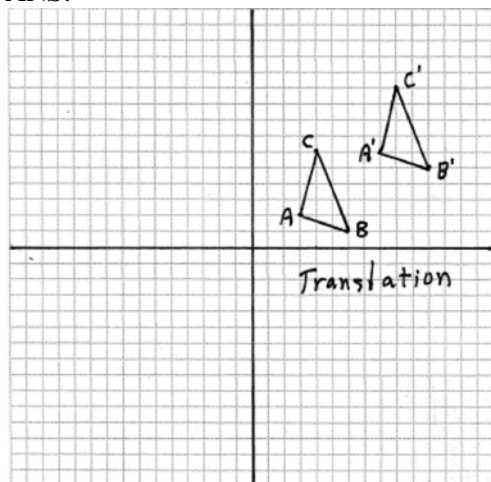

PTS: 2

REF: fall0830ge

STA: G.G.55

TOP: Properties of Transformations

31 ANS:

$$25. d = \sqrt{(-3-4)^2 + (1-25)^2} = \sqrt{49+576} = \sqrt{625} = 25.$$

PTS: 2

REF: fall0831ge

STA: G.G.67

TOP: Distance

32 ANS:

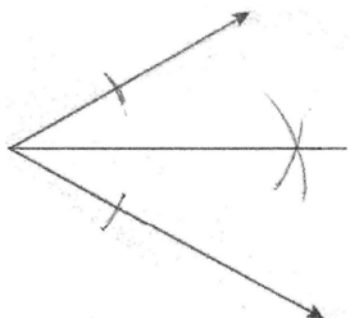

PTS: 2

REF: fall0832ge

STA: G.G.17

TOP: Constructions

33 ANS:

$$22.4. \quad V = \pi r^2 h$$

$$12566.4 = \pi r^2 \cdot 8$$

$$r^2 = \frac{12566.4}{8\pi}$$

$$r \approx 22.4$$

PTS: 2

REF: fall0833ge

STA: G.G.14

TOP: Volume

34 ANS:

Contrapositive-If two angles of a triangle are not congruent, the sides opposite those angles are not congruent.

PTS: 2

REF: fall0834ge

STA: G.G.26

TOP: Conditional Statements

35 ANS:

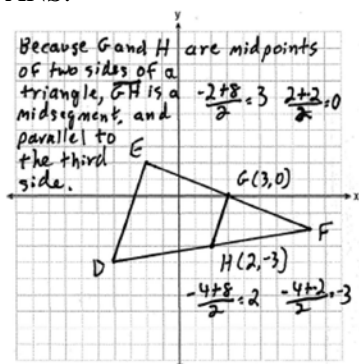

PTS: 4      REF: fall0835ge      STA: G.G.42      TOP: Midsegments

36 ANS:

$\angle D$ ,  $\angle G$  and  $24^\circ$  or  $\angle E$ ,  $\angle F$  and  $84^\circ$ .  $m\widehat{FE} = \frac{2}{15} \times 360 = 48$ . Since the chords forming  $\angle D$  and  $\angle G$  are intercepted by  $\widehat{FE}$ , their measure is  $24^\circ$ .  $m\widehat{GD} = \frac{7}{15} \times 360 = 168$ . Since the chords forming  $\angle E$  and  $\angle F$  are intercepted by  $\widehat{GD}$ , their measure is  $84^\circ$ .

PTS: 4      REF: fall0836ge      STA: G.G.51      TOP: Arcs Determined by Angles

KEY: inscribed

37 ANS:

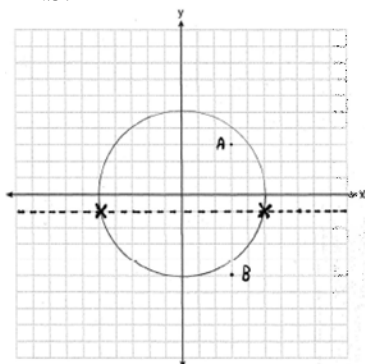

PTS: 4      REF: fall0837ge      STA: G.G.23      TOP: Locus

38 ANS:

Because  $\overline{AB} \parallel \overline{DC}$ ,  $\widehat{AD} \cong \widehat{BC}$  since parallel chords intersect congruent arcs.  $\angle BDC \cong \angle ACD$  because inscribed angles that intercept congruent arcs are congruent.  $\overline{AD} \cong \overline{BC}$  since congruent chords intersect congruent arcs.  $\overline{DC} \cong \overline{CD}$  because of the reflexive property. Therefore,  $\triangle ACD \cong \triangle BDC$  because of SAS.

PTS: 6      REF: fall0838ge      STA: G.G.27      TOP: Circle Proofs

**0609ge**  
**Answer Section**

1 ANS: 1

If  $\angle A$  is at minimum ( $50^\circ$ ) and  $\angle B$  is at minimum ( $90^\circ$ ),  $\angle C$  is at maximum of  $40^\circ$  ( $180^\circ - (50^\circ + 90^\circ)$ ). If  $\angle A$  is at maximum ( $60^\circ$ ) and  $\angle B$  is at maximum ( $100^\circ$ ),  $\angle C$  is at minimum of  $20^\circ$  ( $180^\circ - (60^\circ + 100^\circ)$ ).

PTS: 2

REF: 060901ge

STA: G.G.30

TOP: Interior and Exterior Angles of Triangles

2 ANS: 3

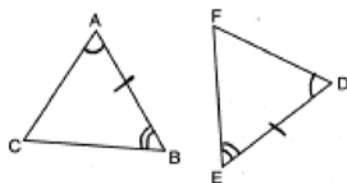

PTS: 2

REF: 060902ge

STA: G.G.28

TOP: Triangle Congruency

3 ANS: 1

PTS: 2

REF: 060903ge

STA: G.G.56

TOP: Identifying Transformations

4 ANS: 4

PTS: 2

REF: 060904ge

STA: G.G.13

TOP: Solids

5 ANS: 3

PTS: 2

REF: 060905ge

STA: G.G.54

TOP: Reflections KEY: basic

6 ANS: 2

Parallel chords intercept congruent arcs.  $m\widehat{AD} = m\widehat{BC} = 60$ .  $m\angle CDB = \frac{1}{2} m\widehat{BC} = 30$ .

PTS: 2

REF: 060906ge

STA: G.G.52

TOP: Chords

7 ANS: 2

The slope of  $y = \frac{1}{2}x + 5$  is  $\frac{1}{2}$ . The slope of a perpendicular line is  $-2$ .  $y = mx + b$

$$5 = (-2)(-2) + b$$

$$b = 1$$

PTS: 2

REF: 060907ge

STA: G.G.64

TOP: Parallel and Perpendicular Lines

8 ANS: 3

PTS: 2

REF: 060908ge

STA: G.G.60

TOP: Identifying Transformations

9 ANS: 1

In an equilateral triangle, each interior angle is  $60^\circ$  and each exterior angle is  $120^\circ$  ( $180^\circ - 60^\circ$ ). The sum of the three interior angles is  $180^\circ$  and the sum of the three exterior angles is  $360^\circ$ .

PTS: 2

REF: 060909ge

STA: G.G.30

TOP: Interior and Exterior Angles of Triangles

10 ANS: 2

PTS: 2

REF: 060910ge

STA: G.G.71

TOP: Equations of Circles

11 ANS: 2

Longest side of a triangle is opposite the largest angle. Shortest side is opposite the smallest angle.

PTS: 2

REF: 060911ge

STA: G.G.34

TOP: Angle Side Relationship

12 ANS: 4 PTS: 2 REF: 060912ge STA: G.G.23  
TOP: Locus

13 ANS: 4 PTS: 2 REF: 060913ge STA: G.G.26  
TOP: Conditional Statements

14 ANS: 2  
The centroid divides each median into segments whose lengths are in the ratio 2 : 1.

PTS: 2 REF: 060914ge STA: G.G.43 TOP: Centroid

15 ANS: 1  
 $\overline{AB} = 10$  since  $\triangle ABC$  is a 6-8-10 triangle.  $6^2 = 10x$   
 $3.6 = x$

PTS: 2 REF: 060915ge STA: G.G.47 TOP: Similarity  
KEY: leg

16 ANS: 3  
 $4(x+4) = 8^2$   
 $4x + 16 = 64$   
 $x = 12$

PTS: 2 REF: 060916ge STA: G.G.53 TOP: Segments Intercepted by Circle  
KEY: tangent and secant

17 ANS: 2

$\angle ACB$  and  $\angle ECD$  are congruent vertical angles and  $\angle CAB \cong \angle CED$ .

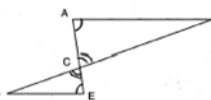

PTS: 2 REF: 060917ge STA: G.G.44 TOP: Similarity Proofs  
18 ANS: 1 PTS: 2 REF: 060918ge STA: G.G.2  
TOP: Planes

19 ANS: 4  
 $M_x = \frac{-6+1}{2} = -\frac{5}{2}$ .  $M_y = \frac{1+8}{2} = \frac{9}{2}$ .

PTS: 2 REF: 060919ge STA: G.G.66 TOP: Midpoint  
20 ANS: 1 PTS: 2 REF: 060920ge STA: G.G.74  
TOP: Graphing Circles

21 ANS: 1  
 $V = \frac{1}{3} \pi r^2 h = \frac{1}{3} \pi \cdot 4^2 \cdot 12 \approx 201$

PTS: 2 REF: 060921ge STA: G.G.15 TOP: Volume and Lateral Area  
22 ANS: 4 PTS: 2 REF: 060922ge STA: G.G.73  
TOP: Equations of Circles



23 ANS: 1

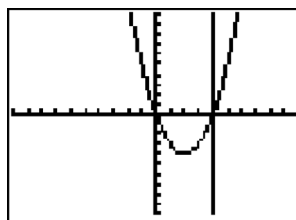

$y = x^2 - 4x = (4)^2 - 4(4) = 0$ . (4,0) is the only intersection.

PTS: 2 REF: 060923ge STA: G.G.70 TOP: Quadratic-Linear Systems

24 ANS: 4

(4) is not true if  $\angle PQR$  is obtuse.

PTS: 2 REF: 060924ge STA: G.G.32 TOP: Exterior Angle Theorem

25 ANS: 3

PTS: 2

REF: 060925ge

STA: G.G.17

TOP: Constructions

26 ANS: 2

The slope of  $2x + 3y = 12$  is  $-\frac{A}{B} = -\frac{2}{3}$ . The slope of a perpendicular line is  $\frac{3}{2}$ . Rewritten in slope intercept form,

(2) becomes  $y = \frac{3}{2}x + 3$ .

PTS: 2 REF: 060926ge STA: G.G.63 TOP: Parallel and Perpendicular Lines

27 ANS: 4

$\triangle ABC \sim \triangle DBE$ .  $\frac{\overline{AB}}{\overline{DB}} = \frac{\overline{AC}}{\overline{DE}}$

$\frac{9}{2} = \frac{x}{3}$

$x = 13.5$

PTS: 2 REF: 060927ge STA: G.G.46 TOP: Side Splitter Theorem

28 ANS: 3

PTS: 2

REF: 060928ge

STA: G.G.8

TOP: Planes

29 ANS:

20. The sides of the triangle formed by connecting the midpoints are half the sides of the original triangle.

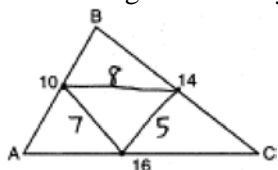

$5 + 7 + 8 = 20$ .

PTS: 2

REF: 060929ge

STA: G.G.42

TOP: Midsegments

30 ANS:

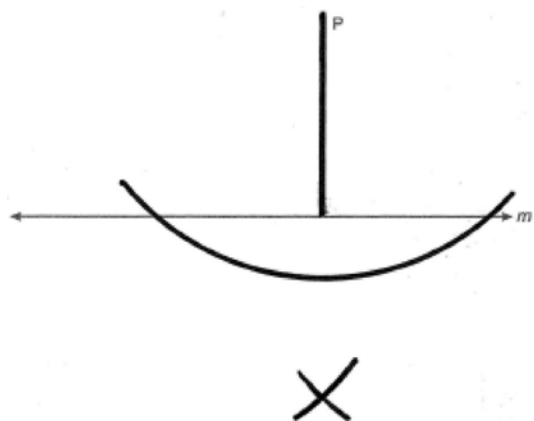

PTS: 2 REF: 060930ge STA: G.G.19 TOP: Constructions

31 ANS:

$y = -2x + 14$ . The slope of  $2x + y = 3$  is  $\frac{-A}{B} = \frac{-2}{1} = -2$ .  $y = mx + b$  .  
 $4 = (-2)(5) + b$   
 $b = 14$

PTS: 2 REF: 060931ge STA: G.G.65 TOP: Parallel and Perpendicular Lines

32 ANS:

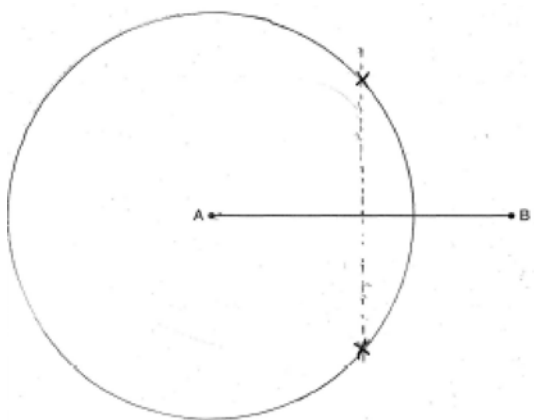

PTS: 2 REF: 060932ge STA: G.G.22 TOP: Locus

33 ANS:

True. The first statement is true and the second statement is false. In a disjunction, if either statement is true, the disjunction is true.

PTS: 2 REF: 060933ge STA: G.G.25 TOP: Compound Statements  
 KEY: disjunction

34 ANS:

$$20. 5x + 10 = 4x + 30$$

$$x = 20$$

PTS: 2

REF: 060934ge

STA: G.G.45

TOP: Similarity

KEY: basic

35 ANS:

18. If the ratio of  $TA$  to  $AC$  is 1:3, the ratio of  $TE$  to  $ES$  is also 1:3.  $x + 3x = 24$ .  $3(6) = 18$ .

$$x = 6$$

PTS: 4

REF: 060935ge

STA: G.G.50

TOP: Tangents

KEY: common tangency

36 ANS:

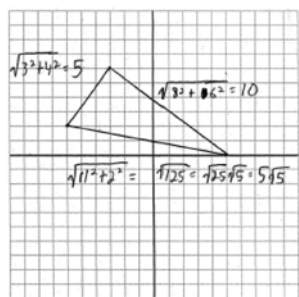

$$15 + 5\sqrt{5}$$

PTS: 4

REF: 060936ge

STA: G.G.69

TOP: Triangles in the Coordinate Plane

37 ANS:

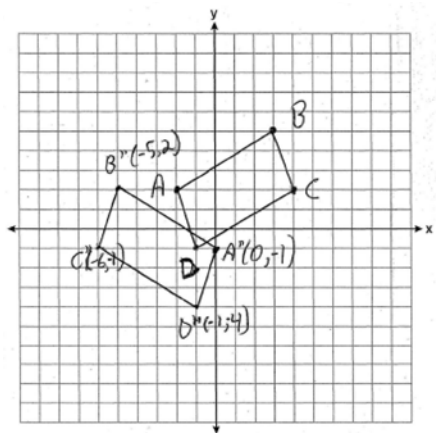

PTS: 4

REF: 060937ge

STA: G.G.54

TOP: Compositions of Transformations

KEY: grids

38 ANS:

$\overline{AC} \cong \overline{EC}$  and  $\overline{DC} \cong \overline{BC}$  because of the definition of midpoint.  $\angle ACB \cong \angle ECD$  because of vertical angles.  $\triangle ABC \cong \triangle EDC$  because of SAS.  $\angle CDE \cong \angle CBA$  because of CPCTC.  $\overline{BD}$  is a transversal intersecting  $\overline{AB}$  and

$\overline{ED}$ . Therefore  $\overline{AB} \parallel \overline{DE}$  because  $\angle CDE$  and  $\angle CBA$  are congruent alternate interior angles.

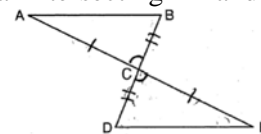

PTS: 6

REF: 060938ge

STA: G.G.27

TOP: Triangle Proofs

**0809ge**  
**Answer Section**

1 ANS: 4

The marked  $60^\circ$  angle and the angle above it are on the same straight line and supplementary. This unmarked supplementary angle is  $120^\circ$ . Because the unmarked  $120^\circ$  angle and the marked  $120^\circ$  angle are alternate exterior angles and congruent,  $d \parallel e$ .

PTS: 2 REF: 080901ge STA: G.G.35 TOP: Parallel Lines and Transversals

2 ANS: 3 PTS: 2 REF: 080902ge STA: G.G.17

TOP: Constructions

3 ANS: 4

$$180 - (40 + 40) = 100$$

PTS: 2 REF: 080903ge STA: G.G.31 TOP: Isosceles Triangle Theorem

4 ANS: 2

Parallel chords intercept congruent arcs.  $\widehat{mAC} = \widehat{mBD} = 30$ .  $180 - 30 - 30 = 120$ .

PTS: 2 REF: 080904ge STA: G.G.52 TOP: Chords

5 ANS: 4 PTS: 2 REF: 080905ge STA: G.G.29

TOP: Triangle Congruency

6 ANS: 2

A dilation affects distance, not angle measure.

PTS: 2 REF: 080906ge STA: G.G.60 TOP: Identifying Transformations

7 ANS: 1

$\angle DCB$  and  $\angle ADC$  are supplementary adjacent angles of a parallelogram.  $180 - 120 = 60$ .  $\angle 2 = 60 - 45 = 15$ .

PTS: 2 REF: 080907ge STA: G.G.38 TOP: Parallelograms

8 ANS: 1

Translations and reflections do not affect distance.

PTS: 2 REF: 080908ge STA: G.G.59 TOP: Properties of Transformations

9 ANS: 3

The slope of  $y = x + 2$  is 1. The slope of  $y - x = -1$  is  $\frac{-A}{B} = \frac{-(-1)}{1} = 1$ .

PTS: 2 REF: 080909ge STA: G.G.63 TOP: Parallel and Perpendicular Lines

10 ANS: 2

$$M_x = \frac{-2+6}{2} = 2. \quad M_y = \frac{-4+2}{2} = -1$$

PTS: 2 REF: 080910ge STA: G.G.66 TOP: Midpoint

11 ANS: 1 PTS: 2 REF: 080911ge STA: G.G.73

TOP: Equations of Circles

12 ANS: 4

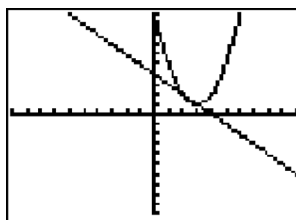

$$y + x = 4 \quad x^2 - 6x + 10 = -x + 4 \quad y + x = 4 \quad y + 2 = 4$$

$$y = -x + 4 \quad x^2 - 5x + 6 = 0 \quad y + 3 = 4 \quad y = 2$$

$$(x - 3)(x - 2) = 0 \quad y = 1$$

$$x = 3 \text{ or } 2$$

PTS: 2 REF: 080912ge STA: G.G.70 TOP: Quadratic-Linear Systems

13 ANS: 3 PTS: 2 REF: 080913ge STA: G.G.28  
TOP: Triangle Congruency

14 ANS: 4 PTS: 2 REF: 080914ge STA: G.G.7  
TOP: Planes

15 ANS: 4 PTS: 2 REF: 080915ge STA: G.G.56  
TOP: Identifying Transformations

16 ANS: 2  
 $6 + 17 > 22$

PTS: 2 REF: 080916ge STA: G.G.33 TOP: Triangle Inequality Theorem

17 ANS: 4

The slope of  $y = -\frac{2}{3}x - 5$  is  $-\frac{2}{3}$ . Perpendicular lines have slope that are opposite reciprocals.

PTS: 2 REF: 080917ge STA: G.G.62 TOP: Parallel and Perpendicular Lines

18 ANS: 1 PTS: 2 REF: 080918ge STA: G.G.41  
TOP: Special Quadrilaterals

19 ANS: 1

$$d = \sqrt{(-4 - 2)^2 + (5 - (-5))^2} = \sqrt{36 + 100} = \sqrt{136} = \sqrt{4 \cdot 34} = 2\sqrt{34}.$$

PTS: 2 REF: 080919ge STA: G.G.67 TOP: Distance

20 ANS: 3

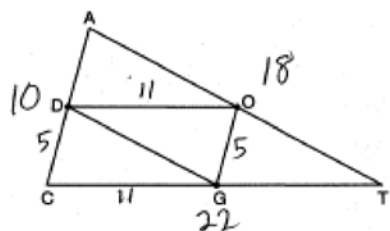

PTS: 2 REF: 080920ge STA: G.G.42 TOP: Midsegments

21 ANS: 2 PTS: 2 REF: 080921ge STA: G.G.72  
TOP: Equations of Circles

22 ANS: 4

$$\text{Let } \overline{AD} = x. \quad 36x = 12^2$$

$$x = 4$$

PTS: 2

REF: 080922ge

STA: G.G.47

TOP: Similarity

KEY: leg

23 ANS: 2

$$4(4x - 3) = 3(2x + 8)$$

$$16x - 12 = 6x + 24$$

$$10x = 36$$

$$x = 3.6$$

PTS: 2

REF: 080923ge

STA: G.G.53

TOP: Segments Intercepted by Circle

KEY: two chords

24 ANS: 3

PTS: 2

REF: 080924ge

STA: G.G.24

TOP: Negations

25 ANS: 4

PTS: 2

REF: 080925ge

STA: G.G.21

TOP: Centroid, Orthocenter, Incenter and Circumcenter

26 ANS: 1

$$V = \pi r^2 h$$

$$1000 = \pi r^2 \cdot 8$$

$$r^2 = \frac{1000}{8\pi}$$

$$r \approx 6.3$$

PTS: 2

REF: 080926ge

STA: G.G.14

TOP: Volume

27 ANS: 2

PTS: 2

REF: 080927ge

STA: G.G.4

TOP: Planes

28 ANS: 3

PTS: 2

REF: 080928ge

STA: G.G.50

TOP: Tangents

KEY: common tangency

29 ANS:

3. The non-parallel sides of an isosceles trapezoid are congruent.  $2x + 5 = 3x + 2$ 

$$x = 3$$

PTS: 2

REF: 080929ge

STA: G.G.40

TOP: Trapezoids

30 ANS:

$$2016. \quad V = \frac{1}{3} Bh = \frac{1}{3} s^2 h = \frac{1}{3} 12^2 \cdot 42 = 2016$$

PTS: 2

REF: 080930ge

STA: G.G.13

TOP: Volume

31 ANS:

$$y = \frac{2}{3}x - 9. \text{ The slope of } 2x - 3y = 11 \text{ is } -\frac{A}{B} = \frac{-2}{-3} = \frac{2}{3}. -5 = \left(\frac{2}{3}\right)(6) + b$$

$$-5 = 4 + b$$

$$b = -9$$

PTS: 2

REF: 080931ge

STA: G.G.65

TOP: Parallel and Perpendicular Lines

32 ANS:

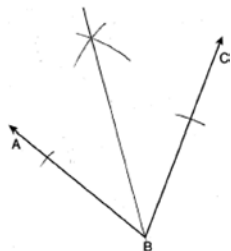

PTS: 2

REF: 080932ge

STA: G.G.17

TOP: Constructions

33 ANS:

$$26. x + 3x + 5x - 54 = 180$$

$$9x = 234$$

$$x = 26$$

PTS: 2

REF: 080933ge

STA: G.G.30

TOP: Interior and Exterior Angles of Triangles

34 ANS:

$\overline{AC}$ .  $m\angle BCA = 63$  and  $m\angle ABC = 80$ .  $\overline{AC}$  is the longest side as it is opposite the largest angle.

PTS: 2

REF: 080934ge

STA: G.G.34

TOP: Angle Side Relationship



35 ANS:

$y = \frac{4}{3}x - 6$ .  $M_x = \frac{-1+7}{2} = 3$  The perpendicular bisector goes through  $(3, -2)$  and has a slope of  $\frac{4}{3}$ .

$$M_y = \frac{1+(-5)}{2} = -2$$

$$m = \frac{1-(-5)}{-1-7} = -\frac{3}{4}$$

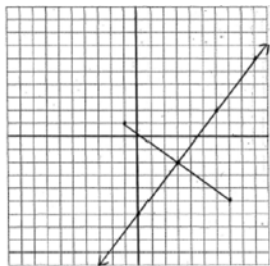

$$y - y_M = m(x - x_M).$$

$$y - 1 = \frac{4}{3}(x - 2)$$

PTS: 4

REF: 080935ge

STA: G.G.68

TOP: Perpendicular Bisector

36 ANS:

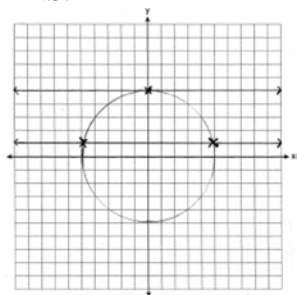

PTS: 4

REF: 080936ge

STA: G.G.23

TOP: Locus

37 ANS:

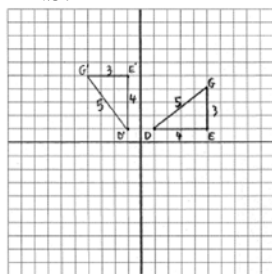

$D'(-1,1), E'(-1,5), G'(-4,5)$

PTS: 4

REF: 080937ge

STA: G.G.55

TOP: Properties of Transformations

38 ANS:

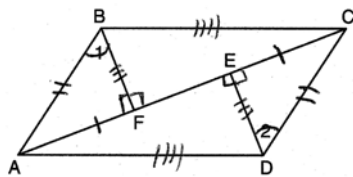

$\overline{FE} \cong \overline{FE}$  (Reflexive Property);  $\overline{AE} - \overline{FE} \cong \overline{FC} - \overline{EF}$  (Line Segment Subtraction Theorem);  $\overline{AF} \cong \overline{CE}$  (Substitution);  $\angle BFA \cong \angle DEC$  (All right angles are congruent);  $\triangle BFA \cong \triangle DEC$  (AAS);  $\overline{AB} \cong \overline{CD}$  and  $\overline{BF} \cong \overline{DE}$  (CPCTC);  $\angle BFC \cong \angle DEA$  (All right angles are congruent);  $\triangle BFC \cong \triangle DEA$  (SAS);  $\overline{AD} \cong \overline{CB}$  (CPCTC);  $ABCD$  is a parallelogram (opposite sides of quadrilateral  $ABCD$  are congruent)

PTS: 6

REF: 080938ge

STA: G.G.41

TOP: Special Quadrilaterals

**0110ge**  
**Answer Section**

1 ANS: 2

The length of the midsegment of a trapezoid is the average of the lengths of its bases.  $\frac{x+30}{2} = 44.$

$$x + 30 = 88$$

$$x = 58$$

PTS: 2                      REF: 011001ge                      STA: G.G.40                      TOP: Trapezoids

2 ANS: 1

$$x + 2x + 2 + 3x + 4 = 180$$

$$6x + 6 = 180$$

$$x = 29$$

PTS: 2                      REF: 011002ge                      STA: G.G.30                      TOP: Interior and Exterior Angles of Triangles

3 ANS: 2                      PTS: 2                      REF: 011003ge                      STA: G.G.55

TOP: Properties of Transformations

4 ANS: 2                      PTS: 2                      REF: 011004ge                      STA: G.G.17

TOP: Constructions

5 ANS: 1

The closer a chord is to the center of a circle, the longer the chord.

PTS: 2                      REF: 011005ge                      STA: G.G.49                      TOP: Chords

6 ANS: 2                      PTS: 2                      REF: 011006ge                      STA: G.G.56

TOP: Isometries

7 ANS: 3                      PTS: 2                      REF: 011007ge                      STA: G.G.31

TOP: Isosceles Triangle Theorem

8 ANS: 4

$$x^2 = (4 + 5) \times 4$$

$$x^2 = 36$$

$$x = 6$$

PTS: 2                      REF: 011008ge                      STA: G.G.53                      TOP: Segments Intercepted by Circle

KEY: tangent and secant

9 ANS: 4                      PTS: 2                      REF: 011009ge                      STA: G.G.19

TOP: Constructions

10 ANS: 3                      PTS: 2                      REF: 011010ge                      STA: G.G.71

TOP: Equations of Circles

11 ANS: 2                      PTS: 2                      REF: 011011ge                      STA: G.G.22

TOP: Locus

12 ANS: 4                      PTS: 2                      REF: 011012ge                      STA: G.G.1

TOP: Planes

13 ANS: 1

Opposite sides of a parallelogram are congruent.  $4x - 3 = x + 3$ .  $SV = (2) + 3 = 5$ .

$$3x = 6$$

$$x = 2$$

PTS: 2

REF: 011013ge

STA: G.G.38

TOP: Parallelograms

14 ANS: 3

$$m = \frac{-A}{B} = \frac{5}{2}, m = \frac{-A}{B} = \frac{10}{4} = \frac{5}{2}$$

PTS: 2

REF: 011014ge

STA: G.G.63

TOP: Parallel and Perpendicular Lines

15 ANS: 2

$$\frac{87+35}{2} = \frac{122}{2} = 61$$

PTS: 2

REF: 011015ge

STA: G.G.51

TOP: Arcs Determined by Angles

KEY: inside circle

16 ANS: 1

$$a^2 + (5\sqrt{2})^2 = (2\sqrt{15})^2$$

$$a^2 + (25 \times 2) = 4 \times 15$$

$$a^2 + 50 = 60$$

$$a^2 = 10$$

$$a = \sqrt{10}$$

PTS: 2

REF: 011016ge

STA: G.G.48

TOP: Pythagorean Theorem

17 ANS: 4

$$d = \sqrt{(-3-1)^2 + (2-0)^2} = \sqrt{16+4} = \sqrt{20} = \sqrt{4} \cdot \sqrt{5} = 2\sqrt{5}$$

PTS: 2

REF: 011017ge

STA: G.G.67

TOP: Distance

18 ANS: 4

The slope of  $y = -3x + 2$  is  $-3$ . The perpendicular slope is  $\frac{1}{3}$ .  $-1 = \frac{1}{3}(3) + b$ 

$$-1 = 1 + b$$

$$b = -2$$

PTS: 2

REF: 011018ge

STA: G.G.64

TOP: Parallel and Perpendicular Lines

19 ANS: 4

PTS: 2

REF: 011019ge

STA: G.G.44

TOP: Similarity Proofs

20 ANS: 2

PTS: 2

REF: 011020ge

STA: G.G.74

TOP: Graphing Circles

21 ANS: 1

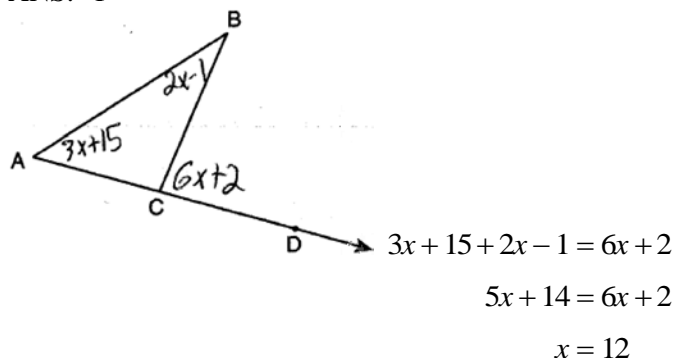

PTS: 2 REF: 011021ge STA: G.G.32 TOP: Exterior Angle Theorem

22 ANS: 2

Because the triangles are similar,  $\frac{m\angle A}{m\angle D} = 1$

PTS: 2 REF: 011022ge STA: G.G.45 TOP: Similarity

KEY: perimeter and area

23 ANS: 3

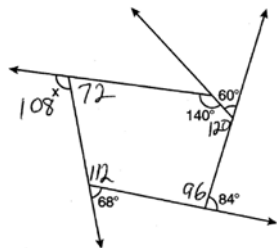

PTS: 2 REF: 011023ge STA: G.G.36 TOP: Interior and Exterior Angles of Polygons

24 ANS: 1 PTS: 2 REF: 011024ge STA: G.G.3  
TOP: Planes

25 ANS: 3

$$m = \frac{-A}{B} = -\frac{3}{4}$$

PTS: 2 REF: 011025ge STA: G.G.62 TOP: Parallel and Perpendicular Lines

26 ANS: 1  
 $A'(2,4)$ PTS: 2 REF: 011023ge STA: G.G.54 TOP: Compositions of Transformations  
KEY: basic

27 ANS: 3

$$V = \pi r^2 h = \pi \cdot 6^2 \cdot 27 = 972\pi$$

PTS: 2 REF: 011027ge STA: G.G.14 TOP: Volume

28 ANS: 3 PTS: 2 REF: 011028ge STA: G.G.26  
TOP: Conditional Statements

29 ANS:

$$67. \frac{180-46}{2} = 67$$

PTS: 2

REF: 011029ge

STA: G.G.31

TOP: Isosceles Triangle Theorem

30 ANS:

$$4. l_1 w_1 h_1 = l_2 w_2 h_2$$

$$10 \times 2 \times h = 5 \times w_2 \times h$$

$$20 = 5w_2$$

$$w_2 = 4$$

PTS: 2

REF: 011030ge

STA: G.G.11

TOP: Volume

31 ANS:

$$(6, -4). C_x = \frac{Q_x + R_x}{2}. C_y = \frac{Q_y + R_y}{2}.$$

$$3.5 = \frac{1 + R_x}{2} \quad 2 = \frac{8 + R_y}{2}$$

$$7 = 1 + R_x \quad 4 = 8 + R_y$$

$$6 = R_x \quad -4 = R_y$$

PTS: 2

REF: 011031ge

STA: G.G.66

TOP: Midpoint

32 ANS:

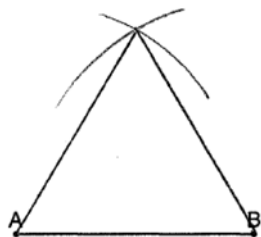

PTS: 2

REF: 011032ge

STA: G.G.20

TOP: Constructions

33 ANS:

$$5. \frac{3}{x} = \frac{6+3}{15}$$

$$9x = 45$$

$$x = 5$$

PTS: 2

REF: 011033ge

STA: G.G.46

TOP: Side Splitter Theorem

34 ANS:

6. The centroid divides each median into segments whose lengths are in the ratio 2 : 1.  $\overline{TD} = 6$  and  $\overline{DB} = 3$

PTS: 2

REF: 011034ge

STA: G.G.43

TOP: Centroid

35 ANS:

36, because a dilation does not affect angle measure. 10, because a dilation does affect distance.

PTS: 4

REF: 011035ge

STA: G.G.59

TOP: Properties of Transformations

36 ANS:

$\overline{JK} \cong \overline{LM}$  because opposite sides of a parallelogram are congruent.  $\overline{LM} \cong \overline{LN}$  because of the Isosceles Triangle Theorem.  $\overline{LM} \cong \overline{JM}$  because of the transitive property.  $JKLM$  is a rhombus because all sides are congruent.

PTS: 4

REF: 011036ge

STA: G.G.41

TOP: Special Quadrilaterals

37 ANS:

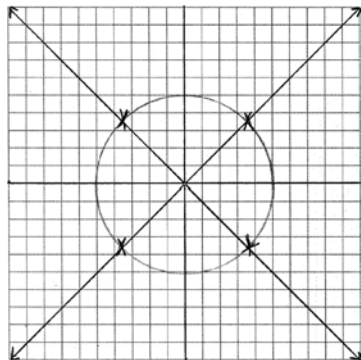

PTS: 4

REF: 011037ge

STA: G.G.23

TOP: Locus

38 ANS:

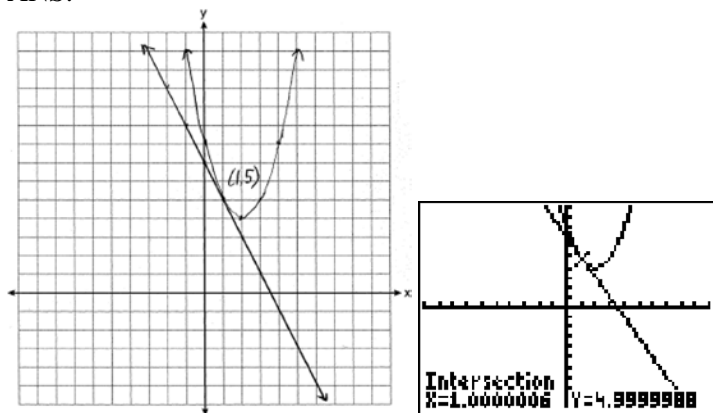

PTS: 6

REF: 011038ge

STA: G.G.70

TOP: Quadratic-Linear Systems

## 0610ge Answer Section

1 ANS: 1

Parallel lines intercept congruent arcs.

PTS: 2

REF: 061001ge

STA: G.G.52

TOP: Chords

2 ANS: 2

PTS: 2

REF: 061002ge

STA: G.G.24

TOP: Negations

3 ANS: 4

PTS: 2

REF: 061003ge

STA: G.G.10

TOP: Solids

4 ANS: 3

PTS: 2

REF: 061004ge

STA: G.G.31

TOP: Isosceles Triangle Theorem

5 ANS: 1

PTS: 2

REF: 061005ge

STA: G.G.55

TOP: Properties of Transformations

6 ANS: 4

$$L = 2\pi rh = 2\pi \cdot 5 \cdot 11 \approx 345.6$$

PTS: 2

REF: 061006ge

STA: G.G.14

TOP: Volume

7 ANS: 2

PTS: 2

REF: 061007ge

STA: G.G.35

TOP: Parallel Lines and Transversals

8 ANS: 4

PTS: 2

REF: 061008ge

STA: G.G.40

TOP: Trapezoids

9 ANS: 1

PTS: 2

REF: 061009ge

STA: G.G.26

TOP: Converse

10 ANS: 1

PTS: 2

REF: 061010ge

STA: G.G.34

TOP: Angle Side Relationship

11 ANS: 3

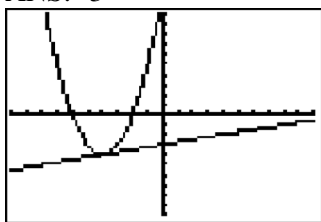

PTS: 2

REF: 061011ge

STA: G.G.70

TOP: Quadratic-Linear Systems

12 ANS: 1

PTS: 2

REF: 061012ge

STA: G.G.20

TOP: Constructions

13 ANS: 1

PTS: 2

REF: 061013ge

STA: G.G.50

TOP: Tangents KEY: point of tangency

14 ANS: 4

The radius is 4.  $r^2 = 16$ .

PTS: 2

REF: 061014ge

STA: G.G.72

TOP: Equations of Circles

15 ANS: 4

PTS: 2

REF: 061015ge

STA: G.G.56

TOP: Identifying Transformations



16 ANS: 3

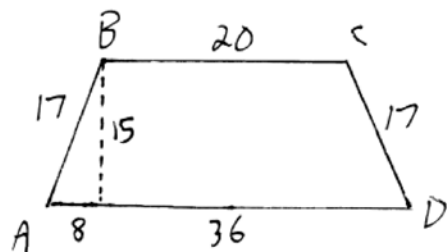

$$\frac{36-20}{2} = 8. \quad \sqrt{17^2 - 8^2} = 15$$

PTS: 2

REF: 061016ge

STA: G.G.40

TOP: Trapezoids

17 ANS: 3

PTS: 2

REF: 061017ge

STA: G.G.1

TOP: Planes

18 ANS: 4

PTS: 2

REF: 061018ge

STA: G.G.56

TOP: Identifying Transformations

19 ANS: 3

$$\frac{36+20}{2} = 28$$

PTS: 2

REF: 061019ge

STA: G.G.51

TOP: Arcs Determined by Angles

KEY: inside circle

20 ANS: 2

PTS: 2

REF: 061020ge

STA: G.G.19

TOP: Constructions

21 ANS: 4

$$d = \sqrt{(146 - (-4))^2 + (52 - 2)^2} = \sqrt{25,000} \approx 158.1$$

PTS: 2

REF: 061021ge

STA: G.G.67

TOP: Distance

22 ANS: 2

PTS: 2

REF: 061022ge

STA: G.G.62

TOP: Parallel and Perpendicular Lines

23 ANS: 2

$$(d+4)4 = 12(6)$$

$$4d + 16 = 72$$

$$d = 14$$

$$r = 7$$

PTS: 2

REF: 061023ge

STA: G.G.53

TOP: Segments Intercepted by Circle

KEY: two secants

24 ANS: 2

$$x^2 + (x+7)^2 = 13^2$$

$$x^2 + x^2 + 7x + 7x + 49 = 169$$

$$2x^2 + 14x - 120 = 0$$

$$x^2 + 7x - 60 = 0$$

$$(x+12)(x-5) = 0$$

$$x = 5$$

$$2x = 10$$

PTS: 2 REF: 061024ge STA: G.G.48 TOP: Pythagorean Theorem

25 ANS: 4

$\overline{BG}$  is also an angle bisector since it intersects the concurrence of  $\overline{CD}$  and  $\overline{AE}$

PTS: 2 REF: 061025ge STA: G.G.21

KEY: Centroid, Orthocenter, Incenter and Circumcenter

26 ANS: 2

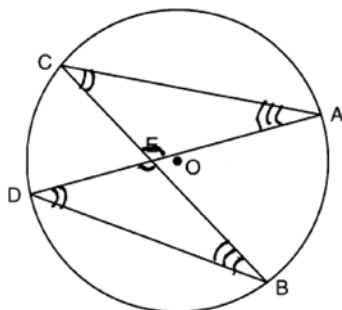

PTS: 2 REF: 061026GE STA: G.G.51 TOP: Arcs Determined by Angles

KEY: inscribed

27 ANS: 1

$$-2\left(-\frac{1}{2}y = 6x + 10\right)$$

$$y = -12x - 20$$

PTS: 2 REF: 061027ge STA: G.G.63 TOP: Parallel and Perpendicular Lines

28 ANS: 2

Adjacent sides of a rectangle are perpendicular and have opposite and reciprocal slopes.

PTS: 2 REF: 061028ge STA: G.G.69 TOP: Quadrilaterals in the Coordinate Plane

29 ANS:

$$452. SA = 4\pi r^2 = 4\pi \cdot 6^2 = 144\pi \approx 452$$

PTS: 2 REF: 061029ge STA: G.G.16 TOP: Volume and Surface Area

30 ANS:

37. Since  $\overline{DE}$  is a midsegment,  $AC = 14$ .  $10 + 13 + 14 = 37$

PTS: 2

REF: 061030ge

STA: G.G.42

TOP: Midsegments

31 ANS:

$$34. 2x - 12 + x + 90 = 180$$

$$3x + 78 = 90$$

$$3x = 102$$

$$x = 34$$

PTS: 2

REF: 061031ge

STA: G.G.30

TOP: Interior and Exterior Angles of Triangles

32 ANS:

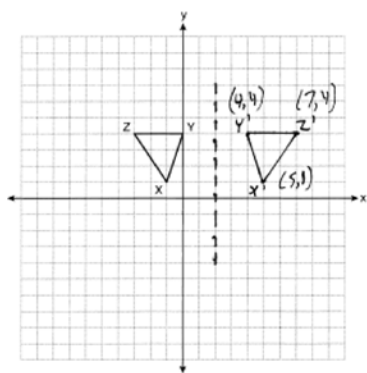

PTS: 2

REF: 061032ge

STA: G.G.54

TOP: Reflections

KEY: grids

33 ANS:

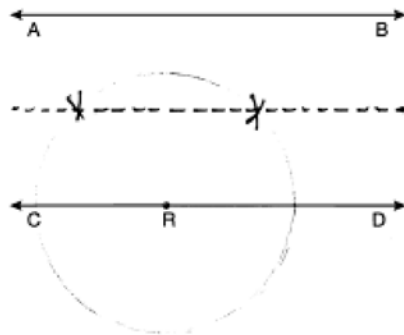

PTS: 2

REF: 061033ge

STA: G.G.22

TOP: Locus

34 ANS:

$$18. \quad V = \frac{1}{3} Bh = \frac{1}{3} lwh$$

$$288 = \frac{1}{3} \cdot 8 \cdot 6 \cdot h$$

$$288 = 16h$$

$$18 = h$$

PTS: 2

REF: 061034ge

STA: G.G.13

TOP: Volume

35 ANS:

$\overline{BD} \cong \overline{DB}$  (Reflexive Property);  $\triangle ABD \cong \triangle CDB$  (SSS);  $\angle BDC \cong \angle ABD$  (CPCTC).

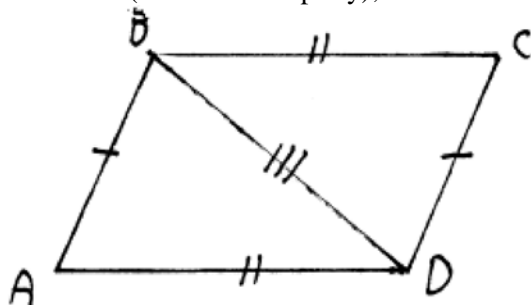

PTS: 4

REF: 061035ge

STA: G.G.27

TOP: Quadrilateral Proofs

36 ANS:

$$y = \frac{2}{3}x + 1. \quad 2y + 3x = 6 \quad . \quad y = mx + b$$

$$2y = -3x + 6 \quad 5 = \frac{2}{3}(6) + b$$

$$y = -\frac{3}{2}x + 3 \quad 5 = 4 + b$$

$$m = -\frac{3}{2} \quad 1 = b$$

$$m_{\perp} = \frac{2}{3} \quad y = \frac{2}{3}x + 1$$

PTS: 4

REF: 061036ge

STA: G.G.64

TOP: Parallel and Perpendicular Lines

37 ANS:

$$\text{Midpoint: } \left( \frac{-4+4}{2}, \frac{2+(-4)}{2} \right) = (0, -1). \text{ Distance: } d = \sqrt{(-4-4)^2 + (2-(-4))^2} = \sqrt{100} = 10$$

$$r = 5$$

$$r^2 = 25$$

$$x^2 + (y+1)^2 = 25$$

PTS: 4

REF: 061037ge

STA: G.G.71

TOP: Equations of Circles

38 ANS:

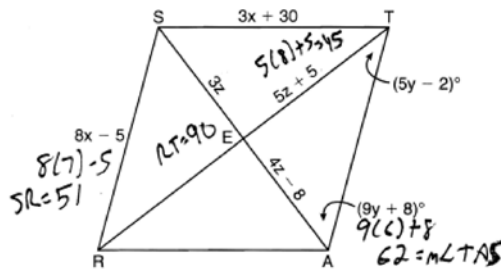

$$8x - 5 = 3x + 30. \quad 4z - 8 = 3z. \quad 9y + 8 + 5y - 2 = 90.$$

$$5x = 35 \quad z = 8 \quad 14y + 6 = 90$$

$$x = 7 \quad 14y = 84$$

$$y = 6$$

PTS: 6

REF: 061038ge

STA: G.G.39

TOP: Special Parallelograms

**0810ge**  
**Answer Section**

1 ANS: 4

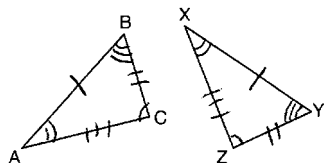

PTS: 2

REF: 081001ge

STA: G.G.29

TOP: Triangle Congruency

2 ANS: 3

PTS: 2

REF: 081002ge

STA: G.G.9

TOP: Planes

3 ANS: 1

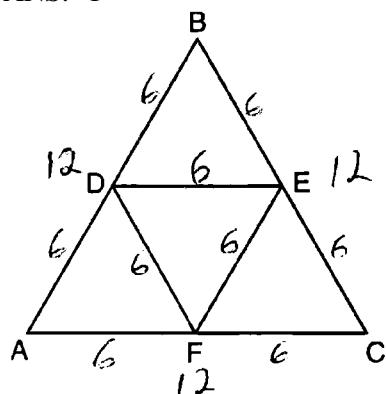

PTS: 2

REF: 081003ge

STA: G.G.42

TOP: Midsegments

4 ANS: 3

$$(x+3)^2 - 4 = 2x + 5$$

$$x^2 + 6x + 9 - 4 = 2x + 5$$

$$x^2 + 4x = 0$$

$$x(x+4) = 0$$

$$x = 0, -4$$

PTS: 2

REF: 081004ge

STA: G.G.70

TOP: Quadratic-Linear Systems

5 ANS: 4

PTS: 2

REF: 081005ge

STA: G.G.18

TOP: Constructions

6 ANS: 4

$$180 - (50 + 30) = 100$$

PTS: 2

REF: 081006ge

STA: G.G.45

TOP: Similarity

KEY: basic

7 ANS: 2

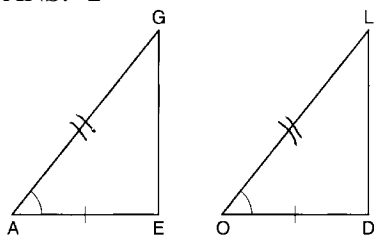

PTS: 2 REF: 081007ge STA: G.G.28 TOP: Triangle Congruency

8 ANS: 1 PTS: 2 REF: 081008ge STA: G.G.3

TOP: Planes

9 ANS: 1 PTS: 2 REF: 081009ge STA: G.G.73

TOP: Equations of Circles

10 ANS: 4

The slope of a line in standard form is  $-\frac{A}{B}$ , so the slope of this line is  $\frac{-4}{2} = -2$ . A parallel line would also have a slope of  $-2$ . Since the answers are in slope intercept form, find the  $y$ -intercept:  $y = mx + b$

$$3 = -2(7) + b$$

$$17 = b$$

PTS: 2 REF: 081010ge STA: G.G.65 TOP: Parallel and Perpendicular Lines

11 ANS: 4

Longest side of a triangle is opposite the largest angle. Shortest side is opposite the smallest angle.

PTS: 2 REF: 081011ge STA: G.G.34 TOP: Angle Side Relationship

12 ANS: 1 PTS: 2 REF: 081012ge STA: G.G.50

TOP: Tangents KEY: two tangents

13 ANS: 4

$$d = \sqrt{(-6-2)^2 + (4-(-5))^2} = \sqrt{64+81} = \sqrt{145}$$

PTS: 2 REF: 081013ge STA: G.G.67 TOP: Distance

14 ANS: 2

$$y + \frac{1}{2}x = 4 \quad 3x + 6y = 12$$

$$y = -\frac{1}{2}x + 4 \quad 6y = -3x + 12$$

$$y = -\frac{3}{6}x + 2$$

$$m = -\frac{1}{2}$$

$$y = -\frac{1}{2}x + 2$$

PTS: 2 REF: 081014ge STA: G.G.63 TOP: Parallel and Perpendicular Lines

15 ANS: 2 PTS: 2 REF: 081015ge STA: G.G.55

TOP: Properties of Transformations

16 ANS: 4

sum of interior  $\angle$ s = sum of exterior  $\angle$ s

$$(n-2)180 = n \left( 180 - \frac{(n-2)180}{n} \right)$$

$$180n - 360 = 180n - 180n + 360$$

$$180n = 720$$

$$n = 4$$

PTS: 2

REF: 081016ge

STA: G.G.36

TOP: Interior and Exterior Angles of Polygons

17 ANS: 1

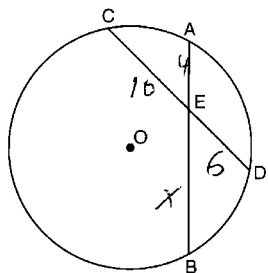

$$4x = 6 \cdot 10$$

$$x = 15$$

PTS: 2

REF: 081017ge

STA: G.G.53

TOP: Segments Intercepted by Circle

KEY: two chords

18 ANS: 1

The centroid divides each median into segments whose lengths are in the ratio 2 : 1.

$$\overline{GC} = 2\overline{FG}$$

$$\overline{GC} + \overline{FG} = 24$$

$$2\overline{FG} + \overline{FG} = 24$$

$$3\overline{FG} = 24$$

$$\overline{FG} = 8$$

PTS: 2

REF: 081018ge

STA: G.G.43

TOP: Centroid

19 ANS: 2

$$M_x = \frac{3x+5+x-1}{2} = \frac{4x+4}{2} = 2x+2. \quad M_y = \frac{3y+(-y)}{2} = \frac{2y}{2} = y.$$

PTS: 2

REF: 081019ge

STA: G.G.66

TOP: Midpoint



20 ANS: 4

$$SA = 4\pi r^2 \quad V = \frac{4}{3}\pi r^3 = \frac{4}{3}\pi \cdot 6^3 = 288\pi$$

$$144\pi = 4\pi r^2$$

$$36 = r^2$$

$$6 = r$$

PTS: 2 REF: 081020ge STA: G.G.16 TOP: Volume and Surface Area

21 ANS: 3 PTS: 2 REF: 081021ge STA: G.G.57

TOP: Properties of Transformations

22 ANS: 1

$$\angle A = \frac{(n-2)180}{n} = \frac{(5-2)180}{5} = 108 \quad \angle AEB = \frac{180-108}{2} = 36$$

PTS: 2 REF: 081022ge STA: G.G.37 TOP: Interior and Exterior Angles of Polygons

23 ANS: 4 PTS: 2 REF: 081023ge STA: G.G.45

TOP: Similarity KEY: perimeter and area

24 ANS: 3

$2y = -6x + 8$  Perpendicular lines have slope the opposite and reciprocal of each other.

$$y = -3x + 4$$

$$m = -3$$

$$m_{\perp} = \frac{1}{3}$$

PTS: 2 REF: 081024ge STA: G.G.62 TOP: Parallel and Perpendicular Lines

25 ANS: 2

$$\frac{140 - \overline{RS}}{2} = 40$$

$$140 - \overline{RS} = 80$$

$$\overline{RS} = 60$$

PTS: 2 REF: 081025ge STA: G.G.51 TOP: Arcs Determined by Angles

KEY: outside circle

26 ANS: 3 PTS: 2 REF: 081026ge STA: G.G.26

TOP: Contrapositive

27 ANS: 2

$$\frac{3}{7} = \frac{6}{x}$$

$$3x = 42$$

$$x = 14$$

PTS: 2 REF: 081027ge STA: G.G.46 TOP: Side Splitter Theorem

28 ANS: 1                      PTS: 2                      REF: 081028ge                      STA: G.G.21  
 TOP: Centroid, Orthocenter, Incenter and Circumcenter

29 ANS:  
 70.  $3x + 5 + 3x + 5 + 2x + 2x = 180$   
 $10x + 10 = 360$   
 $10x = 350$   
 $x = 35$   
 $2x = 70$

PTS: 2                      REF: 081029ge                      STA: G.G.40                      TOP: Trapezoids

30 ANS:  
 $375\pi L = \pi r l = \pi(15)(25) = 375\pi$

PTS: 2                      REF: 081030ge                      STA: G.G.15                      TOP: Volume and Lateral Area

31 ANS:  
 110.  $6x + 20 = x + 40 + 4x - 5$   
 $6x + 20 = 5x + 35$   
 $x = 15$   
 $6((15) + 20 = 110$

PTS: 2                      REF: 081031ge                      STA: G.G.31                      TOP: Isosceles Triangle Theorem

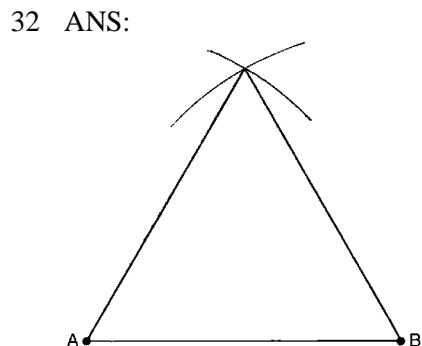

PTS: 2                      REF: 081032ge                      STA: G.G.20                      TOP: Constructions

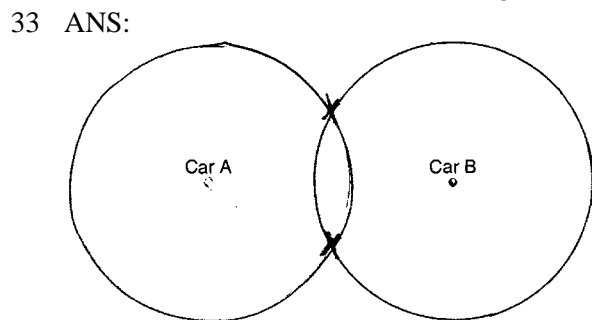

PTS: 2                      REF: 081033ge                      STA: G.G.22                      TOP: Locus

34 ANS:

$$(x+1)^2 + (y-2)^2 = 36$$

PTS: 2

REF: 081034ge

STA: G.G.72

TOP: Equations of Circles

35 ANS:

Yes,  $m\angle ABD = m\angle BDC = 44$   $180 - (93 + 43) = 44$   $x + 19 + 2x + 6 + 3x + 5 = 180$ . Because alternate interior

$$6x + 30 = 180$$

$$6x = 150$$

$$x = 25$$

$$x + 19 = 44$$

angles  $\angle ABD$  and  $\angle CDB$  are congruent,  $\overline{AB}$  is parallel to  $\overline{DC}$ .

PTS: 4

REF: 081035ge

STA: G.G.35

TOP: Parallel Lines and Transversals

36 ANS:

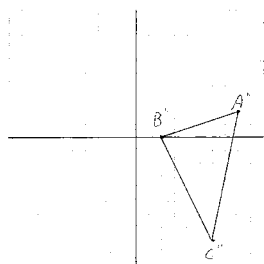

$$A''(8,2), B''(2,0), C''(6,-8)$$

PTS: 4

REF: 081036ge

STA: G.G.58

TOP: Compositions of Transformations

37 ANS:

$$2.4. \quad 5a = 4^2 \quad 5b = 3^2 \quad h^2 = ab$$

$$a = 3.2 \quad b = 1.8 \quad h^2 = 3.2 \cdot 1.8$$

$$h = \sqrt{5.76} = 2.4$$

PTS: 4

REF: 081037ge

STA: G.G.47

TOP: Similarity

KEY: altitude

38 ANS:

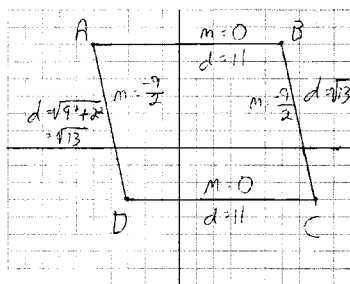

$\overline{AB} \parallel \overline{CD}$  and  $\overline{AD} \parallel \overline{CB}$  because their slopes are equal.  $ABCD$  is a parallelogram because opposite sides are parallel.  $\overline{AB} \neq \overline{BC}$ .  $ABCD$  is not a rhombus because all sides are not equal.  $\overline{AB} \not\perp \overline{BC}$  because their slopes are not opposite reciprocals.  $ABCD$  is not a rectangle because  $\angle ABC$  is not a right angle.

PTS: 4

REF: 081038ge

STA: G.G.69

TOP: Quadrilaterals in the Coordinate Plane

## 0111ge Answer Section

1 ANS: 3

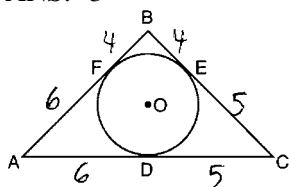

PTS: 2 REF: 011101ge STA: G.G.53 TOP: Segments Intercepted by Circle  
KEY: two tangents

2 ANS: 1 PTS: 2 REF: 011102ge STA: G.G.55  
TOP: Properties of Transformations

3 ANS: 2  
$$\frac{4x + 10}{2} = 2x + 5$$

PTS: 2 REF: 011103ge STA: G.G.42 TOP: Midsegments

4 ANS: 3 PTS: 2 REF: 011104ge STA: G.G.38  
TOP: Parallelograms

5 ANS: 3 PTS: 2 REF: 011105ge STA: G.G.10  
TOP: Solids

6 ANS: 2  
$$M_x = \frac{7 + (-3)}{2} = 2. \quad M_y = \frac{-1 + 3}{2} = 1.$$

PTS: 2 REF: 011106ge STA: G.G.66 TOP: Midpoint

7 ANS: 3  
 $-5 + 3 = -2 \quad 2 + -4 = -2$

PTS: 2 REF: 011107ge STA: G.G.54 TOP: Translations

8 ANS: 4 PTS: 2 REF: 011108ge STA: G.G.27  
TOP: Angle Proofs

9 ANS: 2 PTS: 2 REF: 011109ge STA: G.G.9  
TOP: Planes

10 ANS: 3 PTS: 2 REF: 011110ge STA: G.G.21  
KEY: Centroid, Orthocenter, Incenter and Circumcenter

11 ANS: 3  
 $8^2 + 24^2 \neq 25^2$

PTS: 2 REF: 011111ge STA: G.G.48 TOP: Pythagorean Theorem

12 ANS: 1 PTS: 2 REF: 011112ge STA: G.G.39  
TOP: Special Parallelograms

13 ANS: 3

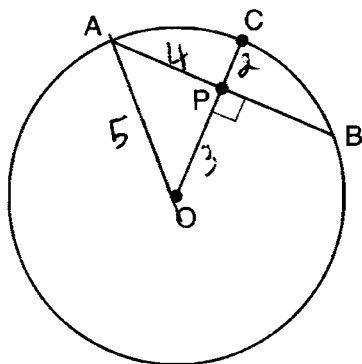

PTS: 2

REF: 011112ge

STA: G.G.49

TOP: Chords

14 ANS: 4

$$y = mx + b$$

$$3 = \frac{3}{2}(-2) + b$$

$$3 = -3 + b$$

$$6 = b$$

PTS: 2

REF: 011114ge

STA: G.G.65

TOP: Parallel and Perpendicular Lines

15 ANS: 4

$$m\angle A = 80$$

PTS: 2

REF: 011115ge

STA: G.G.34

TOP: Angle Side Relationship

16 ANS: 3

PTS: 2

REF: 011116ge

STA: G.G.71

TOP: Equations of Circles

17 ANS: 2

$$V = \pi r^2 h = \pi \cdot 6^2 \cdot 15 = 540\pi$$

PTS: 2

REF: 011117ge

STA: G.G.14

TOP: Volume

18 ANS: 4

PTS: 2

REF: 011118ge

STA: G.G.25

TOP: Compound Statements

KEY: general

19 ANS: 4

$$x + 6y = 12$$

$$3(x - 2) = -y - 4$$

$$6y = -x + 12$$

$$-3(x - 2) = y + 4$$

$$y = -\frac{1}{6}x + 2$$

$$m = -3$$

$$m = -\frac{1}{6}$$

PTS: 2

REF: 011119ge

STA: G.G.63

TOP: Parallel and Perpendicular Lines

20 ANS: 1

PTS: 2

REF: 011120ge

STA: G.G.18

TOP: Constructions

21 ANS: 4

$$d = \sqrt{(-5-3)^2 + (4-(-6))^2} = \sqrt{64+100} = \sqrt{164} = \sqrt{4 \cdot 41} = 2\sqrt{41}$$

PTS: 2 REF: 011121ge STA: G.G.67 TOP: Distance  
KEY: general

22 ANS: 1 PTS: 2 REF: 011122GE STA: G.G.28  
TOP: Triangle Congruency

23 ANS: 4

$$6^2 = x(x+5)$$

$$36 = x^2 + 5x$$

$$0 = x^2 + 5x - 36$$

$$0 = (x+9)(x-4)$$

$$x = 4$$

PTS: 2 REF: 011123ge STA: G.G.47 TOP: Similarity  
KEY: leg

24 ANS: 4 PTS: 2 REF: 011124ge STA: G.G.51  
TOP: Arcs Determined by Angles KEY: inscribed

25 ANS: 2 PTS: 2 REF: 011125ge STA: G.G.74  
TOP: Graphing Circles

26 ANS: 3

$$(3, -2) \rightarrow (2, 3) \rightarrow (8, 12)$$

PTS: 2 REF: 011126ge STA: G.G.54 TOP: Compositions of Transformations  
KEY: basic

27 ANS: 3

$$x + 2x + 15 = 5x + 15 \quad 2(5) + 15 = 25$$

$$3x + 15 = 5x + 15$$

$$10 = 2x$$

$$5 = x$$

PTS: 2 REF: 011127ge STA: G.G.32 TOP: Exterior Angle Theorem

28 ANS: 1 PTS: 2 REF: 011128ge STA: G.G.2

TOP: Planes

29 ANS:

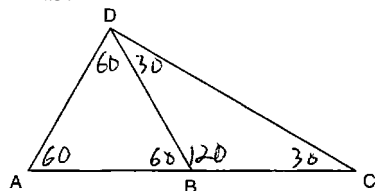

PTS: 2 REF: 011129ge STA: G.G.31 TOP: Isosceles Triangle Theorem

30 ANS:

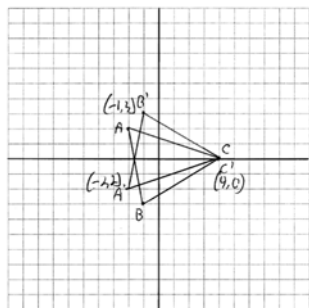

PTS: 2      REF: 011130ge      STA: G.G.54      TOP: Reflections  
 KEY: grids

31 ANS:

$$(5 - 2)180 = 540. \frac{540}{5} = 108 \text{ interior. } 180 - 108 = 72 \text{ exterior}$$

PTS: 2      REF: 011131ge      STA: G.G.37      TOP: Interior and Exterior Angles of Polygons

32 ANS:

$$x^2 = 9 \cdot 8$$

$$x = \sqrt{72}$$

$$x = \sqrt{36} \sqrt{2}$$

$$x = 6\sqrt{2}$$

PTS: 2      REF: 011132ge      STA: G.G.53      TOP: Segments Intercepted by Circle  
 KEY: two chords

33 ANS:

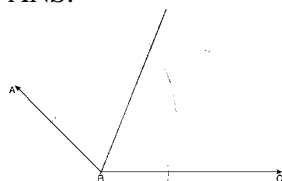

PTS: 2      REF: 011133ge      STA: G.G.17      TOP: Constructions

34 ANS:

$$m = \frac{-A}{B} = \frac{6}{2} = 3. \quad m_{\perp} = -\frac{1}{3}.$$

PTS: 2      REF: 011134ge      STA: G.G.62      TOP: Parallel and Perpendicular Lines



35 ANS:

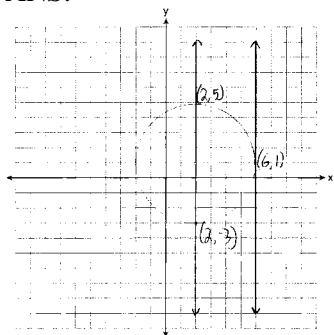

PTS: 4 REF: 011135ge STA: G.G.23 TOP: Locus

36 ANS:

$\angle B$  and  $\angle E$  are right angles because of the definition of perpendicular lines.  $\angle B \cong \angle E$  because all right angles are congruent.  $\angle BFD$  and  $\angle DFE$  are supplementary and  $\angle ECA$  and  $\angle ACB$  are supplementary because of the definition of supplementary angles.  $\angle DFE \cong \angle ACB$  because angles supplementary to congruent angles are congruent.  $\triangle ABC \sim \triangle DEF$  because of AA.

PTS: 4 REF: 011136ge STA: G.G.44 TOP: Similarity Proofs

37 ANS:

$$32. \quad \frac{16}{20} = \frac{x-3}{x+5} \quad \cdot \quad \overline{AC} = x-3 = 35-3 = 32$$

$$16x + 80 = 20x - 60$$

$$140 = 4x$$

$$35 = x$$

PTS: 4 REF: 011137ge STA: G.G.46 TOP: Side Splitter Theorem

38 ANS:

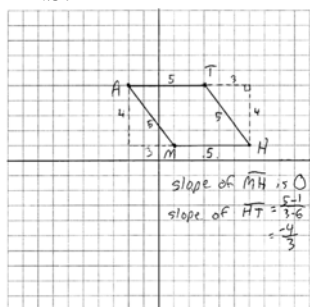

The length of each side of quadrilateral is 5. Since each side is congruent, quadrilateral  $MATH$  is a rhombus. The slope of  $\overline{MH}$  is 0 and the slope of  $\overline{HT}$  is  $-\frac{4}{3}$ . Since the slopes are not negative reciprocals, the sides are not perpendicular and do not form right angles. Since adjacent sides are not perpendicular, quadrilateral  $MATH$  is not a square.

PTS: 6 REF: 011138ge STA: G.G.69 TOP: Quadrilaterals in the Coordinate Plane

**0611ge**  
**Answer Section**

- 1 ANS: 2                   PTS: 2                   REF: 061101ge           STA: G.G.18  
TOP: Constructions
- 2 ANS: 3                   PTS: 2                   REF: 061102ge           STA: G.G.29  
TOP: Triangle Congruency
- 3 ANS: 4                   PTS: 2                   REF: 061103ge           STA: G.G.60  
TOP: Identifying Transformations
- 4 ANS: 1                   PTS: 2                   REF: 061104ge           STA: G.G.43  
TOP: Centroid
- 5 ANS: 1  
Parallel lines intercept congruent arcs.
- PTS: 2                   REF: 061105ge           STA: G.G.52           TOP: Chords
- 6 ANS: 2  
 $7x = 5x + 30$   
 $2x = 30$   
 $x = 15$
- PTS: 2                   REF: 061106ge           STA: G.G.35           TOP: Parallel Lines and Transversals
- 7 ANS: 2                   PTS: 2                   REF: 061107ge           STA: G.G.32  
TOP: Exterior Angle Theorem
- 8 ANS: 1                   PTS: 2                   REF: 061108ge           STA: G.G.9  
TOP: Planes
- 9 ANS: 2  
 $d = \sqrt{(-1 - 7)^2 + (9 - 4)^2} = \sqrt{64 + 25} = \sqrt{89}$
- PTS: 2                   REF: 061109ge           STA: G.G.67           TOP: Distance  
KEY: general
- 10 ANS: 1                   PTS: 2                   REF: 061110ge           STA: G.G.72  
TOP: Equations of Circles
- 11 ANS: 3                   PTS: 2                   REF: 061111ge           STA: G.G.38  
TOP: Parallelograms
- 12 ANS: 2  
 $V = \frac{4}{3} \pi r^3 = \frac{4}{3} \pi \cdot 3^3 = 36\pi$
- PTS: 2                   REF: 061112ge           STA: G.G.16           TOP: Volume and Surface Area
- 13 ANS: 1                   PTS: 2                   REF: 061113ge           STA: G.G.63  
TOP: Parallel and Perpendicular Lines
- 14 ANS: 4                   PTS: 2                   REF: 061114ge           STA: G.G.73  
TOP: Equations of Circles
- 15 ANS: 2                   PTS: 2                   REF: 061115ge           STA: G.G.69  
TOP: Triangles in the Coordinate Plane

16 ANS: 3  
 $\sqrt{5^2 + 12^2} = 13$

PTS: 2 REF: 061116ge STA: G.G.39 TOP: Special Parallelograms

17 ANS: 4  
 $4(x+4) = 8^2$   
 $4x + 16 = 64$   
 $4x = 48$   
 $x = 12$

PTS: 2 REF: 061117ge STA: G.G.53 TOP: Segments Intercepted by Circle  
 KEY: tangent and secant

18 ANS: 4 PTS: 2 REF: 061118ge STA: G.G.1  
 TOP: Planes

19 ANS: 1  
 $3x + 5 + 4x - 15 + 2x + 10 = 180$ .  $m\angle D = 3(20) + 5 = 65$ .  $m\angle E = 4(20) - 15 = 65$ .  
 $9x = 180$   
 $x = 20$

PTS: 2 REF: 061119ge STA: G.G.30 TOP: Interior and Exterior Angles of Triangles

20 ANS: 3  
 $\frac{7x}{4} = \frac{7}{x}$ .  $7(2) = 14$   
 $7x^2 = 28$   
 $x = 2$

PTS: 2 REF: 061120ge STA: G.G.45 TOP: Similarity  
 KEY: basic

21 ANS: 2 PTS: 2 REF: 061121ge STA: G.G.22  
 TOP: Locus

22 ANS: 3 PTS: 2 REF: 061122ge STA: G.G.56  
 TOP: Identifying Transformations

23 ANS: 2

The slope of a line in standard form is  $-\frac{A}{B}$ , so the slope of this line is  $-\frac{4}{3}$ . A parallel line would also have a slope of  $-\frac{4}{3}$ . Since the answers are in standard form, use the point-slope formula.  $y - 2 = -\frac{4}{3}(x + 5)$

$$3y - 6 = -4x - 20$$

$$4x + 3y = -14$$

PTS: 2 REF: 061123ge STA: G.G.65 TOP: Parallel and Perpendicular Lines

24 ANS: 4                   PTS: 2                   REF: 061124ge           STA: G.G.31  
TOP: Isosceles Triangle Theorem

25 ANS: 1                   PTS: 2                   REF: 061125ge           STA: G.G.39  
TOP: Special Parallelograms

26 ANS: 2                   PTS: 2                   REF: 061126ge           STA: G.G.59  
TOP: Properties of Transformations

27 ANS: 4

The slope of  $3x + 5y = 4$  is  $m = \frac{-A}{B} = \frac{-3}{5}$ .  $m_{\perp} = \frac{5}{3}$ .

PTS: 2                   REF: 061127ge           STA: G.G.62           TOP: Parallel and Perpendicular Lines

28 ANS: 1  
 $x^2 = 7(16 - 7)$

$$x^2 = 63$$

$$x = \sqrt{9}\sqrt{7}$$

$$x = 3\sqrt{7}$$

PTS: 2                   REF: 061128ge           STA: G.G.47           TOP: Similarity  
KEY: altitude

29 ANS:  
The medians of a triangle are not concurrent. False.

PTS: 2                   REF: 061129ge           STA: G.G.24           TOP: Negations

30 ANS:

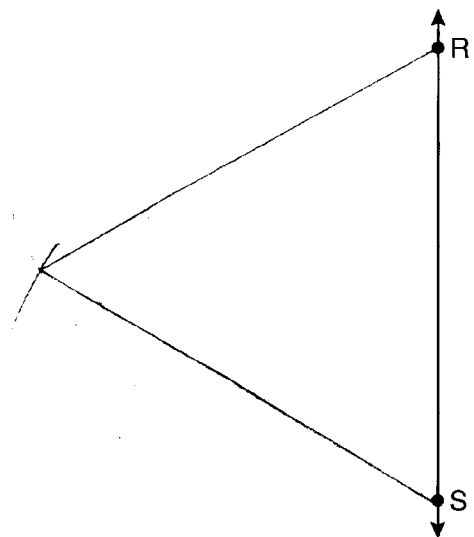

PTS: 2                   REF: 061130ge           STA: G.G.20           TOP: Constructions

31 ANS:

$$9.1. (11)(8)h = 800$$

$$h \approx 9.1$$

PTS: 2

REF: 061131ge

STA: G.G.12

TOP: Volume

32 ANS:

Yes. A reflection is an isometry.

PTS: 2

REF: 061132ge

STA: G.G.56

TOP: Identifying Transformations

33 ANS:

$$16.7. \frac{x}{25} = \frac{12}{18}$$

$$18x = 300$$

$$x \approx 16.7$$

PTS: 2

REF: 061133ge

STA: G.G.46

TOP: Side Splitter Theorem

34 ANS:

$$(2a-3, 3b+2). \left( \frac{3a+a-6}{2}, \frac{2b-1+4b+5}{2} \right) = \left( \frac{4a-6}{2}, \frac{6b+4}{2} \right) = (2a-3, 3b+2)$$

PTS: 2

REF: 061134ge

STA: G.G.66

TOP: Midpoint

35 ANS:

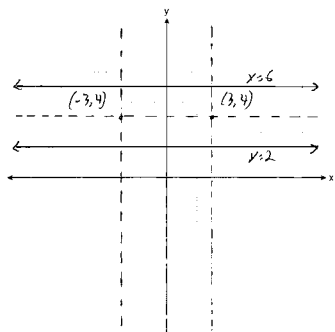

PTS: 4

REF: 061135ge

STA: G.G.23

TOP: Locus

36 ANS:

$$30. 3x + 4x + 5x = 360. \widehat{mLN} : \widehat{mNK} : \widehat{mKL} = 90 : 120 : 150. \frac{150-90}{2} = 30$$

$$x = 20$$

PTS: 4

REF: 061136ge

STA: G.G.51

TOP: Arcs Determined by Angles

KEY: outside circle

37 ANS:

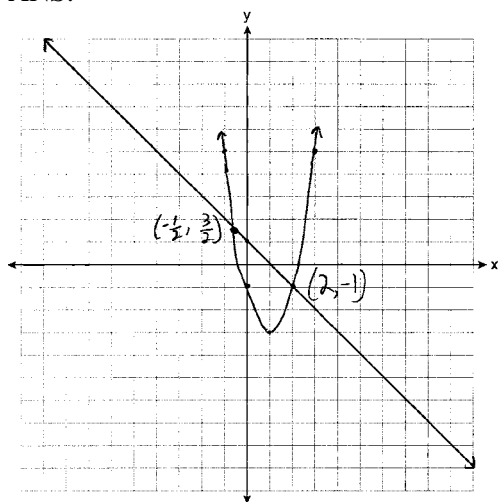

PTS: 4

REF: 061137ge

STA: G.G.70

TOP: Quadratic-Linear Systems

38 ANS:

$\overline{OA} \cong \overline{OB}$  because all radii are equal.  $\overline{OP} \cong \overline{OP}$  because of the reflexive property.  $\overline{OA} \perp \overline{PA}$  and  $\overline{OB} \perp \overline{PB}$  because tangents to a circle are perpendicular to a radius at a point on a circle.  $\angle PAO$  and  $\angle PBO$  are right angles because of the definition of perpendicular.  $\angle PAO \cong \angle PBO$  because all right angles are congruent.  $\triangle AOP \cong \triangle BOP$  because of HL.  $\angle AOP \cong \angle BOP$  because of CPCTC.

PTS: 6

REF: 061138ge

STA: G.G.27

TOP: Circle Proofs

**0811ge**  
**Answer Section**

- 1 ANS: 4                   PTS: 2                   REF: 081101ge           STA: G.G.25  
TOP: Compound Statements           KEY: conjunction
- 2 ANS: 2                   PTS: 2                   REF: 081102ge           STA: G.G.29  
TOP: Triangle Congruency
- 3 ANS: 3  
 $\frac{5}{7} = \frac{10}{x}$   
 $5x = 70$   
 $x = 14$
- PTS: 2                   REF: 081103ge           STA: G.G.46           TOP: Side Splitter Theorem
- 4 ANS: 3                   PTS: 2                   REF: 081104ge           STA: G.G.55  
TOP: Properties of Transformations
- 5 ANS: 4  
 $\sqrt{25^2 - 7^2} = 24$
- PTS: 2                   REF: 081105ge           STA: G.G.50           TOP: Tangents  
KEY: point of tangency
- 6 ANS: 4                   PTS: 2                   REF: 081106ge           STA: G.G.17  
TOP: Constructions
- 7 ANS: 3  
 $d = \sqrt{(1-9)^2 + (-4-2)^2} = \sqrt{64+36} = \sqrt{100} = 10$
- PTS: 2                   REF: 081107ge           STA: G.G.67           TOP: Distance  
KEY: general
- 8 ANS: 2                   PTS: 2                   REF: 081108ge           STA: G.G.54  
TOP: Reflections   KEY: basic
- 9 ANS: 3  
 $7x = 5x + 30$   
 $2x = 30$   
 $x = 15$
- PTS: 2                   REF: 081109ge           STA: G.G.35           TOP: Parallel Lines and Transversals
- 10 ANS: 4                   PTS: 2                   REF: 081110ge           STA: G.G.71  
TOP: Equations of Circles
- 11 ANS: 3                   PTS: 2                   REF: 081111ge           STA: G.G.32  
TOP: Exterior Angle Theorem

12 ANS: 2

$$m = \frac{-A}{B} = \frac{-4}{2} = -2 \quad y = mx + b$$

$$2 = -2(2) + b$$

$$6 = b$$

PTS: 2

REF: 081112ge

STA: G.G.65

TOP: Parallel and Perpendicular Lines

13 ANS: 1

PTS: 2

REF: 081113ge

STA: G.G.54

TOP: Reflections

KEY: basic

14 ANS: 4

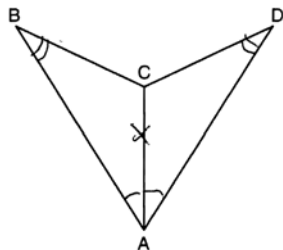

PTS: 2

REF: 081114ge

STA: G.G.28

TOP: Triangle Congruency

15 ANS: 1

$$1 = \frac{-4+x}{2} \quad 5 = \frac{3+y}{2}$$

$$-4+x=2 \quad 3+y=10$$

$$x=6 \quad y=7$$

PTS: 2

REF: 081115ge

STA: G.G.66

TOP: Midpoint

16 ANS: 1

PTS: 2

REF: 081116ge

STA: G.G.7

TOP: Planes

17 ANS: 2

PTS: 2

REF: 081117ge

STA: G.G.23

TOP: Locus

18 ANS: 3

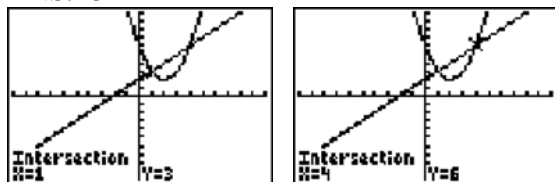

PTS: 2

REF: 081118ge

STA: G.G.70

TOP: Quadratic-Linear Systems

19 ANS: 4

$$\frac{5}{2+3+5} \times 180 = 90$$

PTS: 2

REF: 081119ge

STA: G.G.30

TOP: Interior and Exterior Angles of Triangles

20 ANS: 2

PTS: 2

REF: 081120ge

STA: G.G.8

TOP: Planes



21 ANS: 1 PTS: 2 REF: 081121ge STA: G.G.39  
TOP: Special Parallelograms

22 ANS: 2

The slope of  $x + 2y = 3$  is  $m = \frac{-A}{B} = \frac{-1}{2}$ .  $m_{\perp} = 2$ .

PTS: 2 REF: 081122ge STA: G.G.62 TOP: Parallel and Perpendicular Lines

23 ANS: 3 PTS: 2 REF: 081123ge STA: G.G.12

TOP: Volume

24 ANS: 4

$$\sqrt{6^2 - 2^2} = \sqrt{32} = \sqrt{16} \sqrt{2} = 4\sqrt{2}$$

PTS: 2 REF: 081124ge STA: G.G.49 TOP: Chords

25 ANS: 2

$$(n - 2)180 = (6 - 2)180 = 720. \frac{720}{6} = 120.$$

PTS: 2 REF: 081125ge STA: G.G.37 TOP: Interior and Exterior Angles of Polygons

26 ANS: 1

$$m = \left( \frac{8+0}{2}, \frac{2+6}{2} \right) = (4, 4) \quad m = \frac{6-2}{0-8} = \frac{4}{-8} = -\frac{1}{2} \quad m_{\perp} = 2 \quad y = mx + b$$

$$4 = 2(4) + b$$

$$-4 = b$$

PTS: 2 REF: 081126ge STA: G.G.68 TOP: Perpendicular Bisector

27 ANS: 3

$$x^2 + 7^2 = (x + 1)^2 \quad x + 1 = 25$$

$$x^2 + 49 = x^2 + 2x + 1$$

$$48 = 2x$$

$$24 = x$$

PTS: 2 REF: 081127ge STA: G.G.48 TOP: Pythagorean Theorem

28 ANS: 3 PTS: 2 REF: 081128ge STA: G.G.39

TOP: Special Parallelograms

29 ANS:

$$\frac{180 - 80}{2} = 50$$

PTS: 2 REF: 081129ge STA: G.G.52 TOP: Chords

30 ANS:

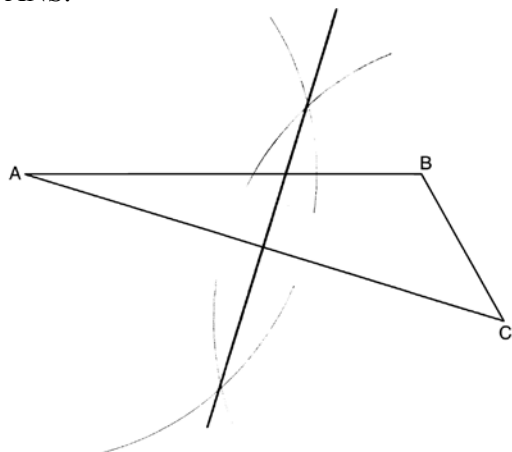

PTS: 2 REF: 081130ge STA: G.G.18 TOP: Constructions

31 ANS:

$$V = \frac{4}{3} \pi \cdot 9^3 = 972\pi$$

PTS: 2 REF: 081131ge STA: G.G.16 TOP: Surface Area

32 ANS:

$$(x - 5)^2 + (y + 4)^2 = 36$$

PTS: 2 REF: 081132ge STA: G.G.72 TOP: Equations of Circles

33 ANS:

$\angle ACB \cong \angle AED$  is given.  $\angle A \cong \angle A$  because of the reflexive property. Therefore  $\triangle ABC \sim \triangle ADE$  because of AA.

PTS: 2 REF: 081133ge STA: G.G.44 TOP: Similarity Proofs

34 ANS:

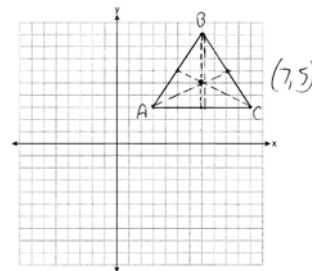

$$(7, 5) \quad m_{\overline{AB}} = \left( \frac{3+7}{2}, \frac{3+9}{2} \right) = (5, 6) \quad m_{\overline{BC}} = \left( \frac{7+11}{2}, \frac{9+3}{2} \right) = (9, 6)$$

PTS: 2 REF: 081134ge STA: G.G.21  
 TOP: Centroid, Orthocenter, Incenter and Circumcenter

35 ANS:

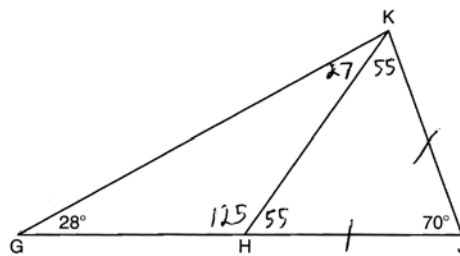
No,  $\angle KGH$  is not congruent to  $\angle GKH$ .

PTS: 2

REF: 081135ge

STA: G.G.31

TOP: Isosceles Triangle Theorem

36 ANS:

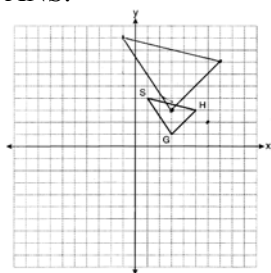
 $G''(3,3), H''(7,7), S''(-1,9)$ 

PTS: 4

REF: 081136ge

STA: G.G.58

TOP: Compositions of Transformations

37 ANS:

$$2 \quad \frac{x+2}{x} = \frac{x+6}{4}$$

$$x^2 + 6x = 4x + 8$$

$$x^2 + 2x - 8 = 0$$

$$(x+4)(x-2) = 0$$

$$x = 2$$

PTS: 4

REF: 081137ge

STA: G.G.45

TOP: Similarity

KEY: basic

38 ANS:

$m_{\overline{AB}} = \left( \frac{-6+2}{2}, \frac{-2+8}{2} \right) = D(2,3)$   $m_{\overline{BC}} = \left( \frac{2+6}{2}, \frac{8+-2}{2} \right) = E(4,3)$   $F(0,-2)$ . To prove that  $ADEF$  is a parallelogram, show that both pairs of opposite sides of the parallelogram are parallel by showing the opposite sides have the same slope:  $m_{\overline{AD}} = \frac{3--2}{-2--6} = \frac{5}{4}$   $\overline{AF} \parallel \overline{DE}$  because all horizontal lines have the same slope.  $ADEF$

$$m_{\overline{FE}} = \frac{3--2}{4-0} = \frac{5}{4}$$

is not a rhombus because not all sides are congruent.  $AD = \sqrt{5^2 + 4^2} = \sqrt{41}$   $AF = 6$

PTS: 6

REF: 081138ge

STA: G.G.69

TOP: Quadrilaterals in the Coordinate Plane

## 0112ge Answer Section

1 ANS: 2

$$6x + 42 = 18x - 12$$

$$54 = 12x$$

$$x = \frac{54}{12} = 4.5$$

PTS: 2 REF: 011201ge STA: G.G.35 TOP: Parallel Lines and Transversals

2 ANS: 3 PTS: 2 REF: 011202ge STA: G.G.21

TOP: Centroid, Orthocenter, Incenter and Circumcenter

3 ANS: 2 PTS: 2 REF: 011203ge STA: G.G.73

TOP: Equations of Circles

4 ANS: 2

The diagonals of a rhombus are perpendicular.  $180 - (90 + 12) = 78$ 

PTS: 2 REF: 011204ge STA: G.G.39 TOP: Special Parallelograms

5 ANS: 1

$$d = \sqrt{(4 - 1)^2 + (7 - 11)^2} = \sqrt{9 + 16} = \sqrt{25} = 5$$

PTS: 2 REF: 011205ge STA: G.G.67 TOP: Distance

KEY: general

6 ANS: 2 PTS: 2 REF: 011206ge STA: G.G.32

TOP: Exterior Angle Theorem

7 ANS: 1 PTS: 2 REF: 011207ge STA: G.G.20

TOP: Constructions

8 ANS: 4 PTS: 2 REF: 011208ge STA: G.G.53

TOP: Segments Intercepted by Circle KEY: two tangents

9 ANS: 3 PTS: 2 REF: 011209ge STA: G.G.44

TOP: Similarity Proofs

10 ANS: 3

$$\frac{3}{8 + 3 + 4} \times 180 = 36$$

PTS: 2 REF: 011210ge STA: G.G.30 TOP: Interior and Exterior Angles of Triangles

11 ANS: 2 PTS: 2 REF: 011211ge STA: G.G.55

TOP: Properties of Transformations

12 ANS: 4 PTS: 2 REF: 011212ge STA: G.G.71

TOP: Equations of Circles

13 ANS: 1 PTS: 2 REF: 011213ge STA: G.G.24

TOP: Negations

14 ANS: 2

$$\frac{50+x}{2} = 34$$

$$50+x = 68$$

$$x = 18$$

PTS: 2 REF: 011214ge STA: G.G.51 TOP: Arcs Determined by Angles  
KEY: inside circle

15 ANS: 2 PTS: 2 REF: 011215ge STA: G.G.12  
TOP: Volume

16 ANS: 4 PTS: 2 REF: 011216ge STA: G.G.29  
TOP: Triangle Congruency

17 ANS: 3 PTS: 2 REF: 011217ge STA: G.G.64  
TOP: Parallel and Perpendicular Lines

18 ANS: 1 PTS: 2 REF: 011218ge STA: G.G.3  
TOP: Planes

19 ANS: 4

$$\sqrt{25^2 - \left(\frac{26-12}{2}\right)^2} = 24$$

PTS: 2 REF: 011219ge STA: G.G.40 TOP: Trapezoids

20 ANS: 1 PTS: 2 REF: 011220ge STA: G.G.72  
TOP: Equations of Circles

21 ANS: 1 PTS: 2 REF: 011221ge STA: G.G.10  
TOP: Solids

22 ANS: 4 PTS: 2 REF: 011222ge STA: G.G.34  
TOP: Angle Side Relationship

23 ANS: 3  
 $(n-2)180 = (5-2)180 = 540$

PTS: 2 REF: 011223ge STA: G.G.36 TOP: Interior and Exterior Angles of Polygons

24 ANS: 3

$$y = mx + b$$

$$-1 = 2(2) + b$$

$$-5 = b$$

PTS: 2 REF: 011224ge STA: G.G.65 TOP: Parallel and Perpendicular Lines

25 ANS: 4

$\overline{AB}$  is a vertical line, so its perpendicular bisector is a horizontal line through the midpoint of  $\overline{AB}$ , which is (0, 3).

PTS: 2 REF: 011225ge STA: G.G.68 TOP: Perpendicular Bisector

26 ANS: 1

$$7x + 4 = 2(2x + 5). \quad PM = 2(2) + 5 = 9$$

$$7x + 4 = 4x + 10$$

$$3x = 6$$

$$x = 2$$

PTS: 2

REF: 011226ge

STA: G.G.43

TOP: Centroid

27 ANS: 4

$$x \cdot 4x = 6^2. \quad PQ = 4x + x = 5x = 5(3) = 15$$

$$4x^2 = 36$$

$$x = 3$$

PTS: 2

REF: 011227ge

STA: G.G.47

TOP: Similarity

KEY: leg

28 ANS: 2

$$5 - 3 = 2, 5 + 3 = 8$$

PTS: 2

REF: 011228ge

STA: G.G.33

TOP: Triangle Inequality Theorem

29 ANS:

$$2x - 20 = x + 20. \quad \widehat{mAB} = x + 20 = 40 + 20 = 60$$

$$x = 40$$

PTS: 2

REF: 011229ge

STA: G.G.52

TOP: Chords

30 ANS:

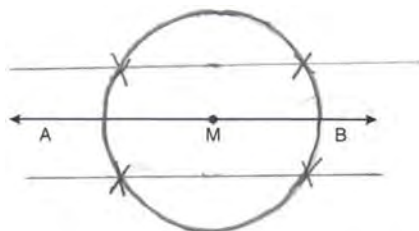

PTS: 2

REF: 011230ge

STA: G.G.22

TOP: Locus

31 ANS:

The slope of  $y = 2x + 3$  is 2. The slope of  $2y + x = 6$  is  $\frac{-A}{B} = \frac{-1}{2}$ . Since the slopes are opposite reciprocals, the lines are perpendicular.

PTS: 2

REF: 011231ge

STA: G.G.63

TOP: Parallel and Perpendicular Lines

32 ANS:

$R'(-3, -2)$ ,  $S'(-4, 4)$ , and  $T'(2, 2)$ .

PTS: 2

REF: 011232ge

STA: G.G.54

TOP: Rotations

33 ANS:

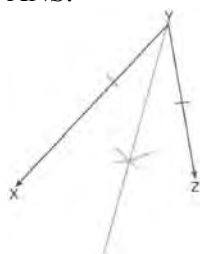

PTS: 2 REF: 011233ge STA: G.G.17 TOP: Constructions

34 ANS:

$$EO = 6. CE = \sqrt{10^2 - 6^2} = 8$$

PTS: 2 REF: 011234ge STA: G.G.49 TOP: Chords

35 ANS:

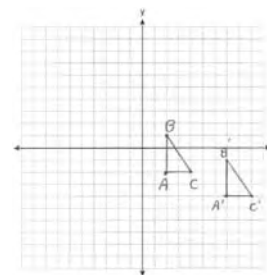

$A'(7, -4), B'(7, -1), C'(9, -4)$ . The areas are equal because translations preserve distance.

PTS: 4 REF: 011235ge STA: G.G.55 TOP: Properties of Transformations

36 ANS:

$$V = \pi r^2 h \quad L = 2\pi r h = 2\pi \cdot 5\sqrt{2} \cdot 12 \approx 533.1$$

$$600\pi = \pi r^2 \cdot 12$$

$$50 = r^2$$

$$\sqrt{25} \sqrt{2} = r$$

$$5\sqrt{2} = r$$

PTS: 4 REF: 011236ge STA: G.G.14 TOP: Volume

37 ANS:

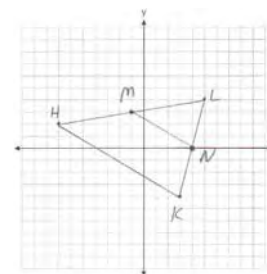

$$M\left(\frac{-7+3}{2}, \frac{3+3}{2}\right) = M(-1, 3). \quad N\left(\frac{-3+3}{2}, \frac{3+0}{2}\right) = N(0, 1.5)$$

$\overline{MN}$  is a midsegment.

PTS: 4 REF: 011237ge STA: G.G.42 TOP: Midsegments

38 ANS:

Quadrilateral  $ABCD$ ,  $\overline{AD} \cong \overline{BC}$  and  $\angle DAE \cong \angle BCE$  are given.  $\overline{AD} \parallel \overline{BC}$  because if two lines are cut by a transversal so that a pair of alternate interior angles are congruent, the lines are parallel.  $ABCD$  is a parallelogram because if one pair of opposite sides of a quadrilateral are both congruent and parallel, the quadrilateral is a parallelogram.  $\overline{AE} \cong \overline{CE}$  because the diagonals of a parallelogram bisect each other.  $\angle FEA \cong \angle GEC$  as vertical angles.  $\triangle AEF \cong \triangle CEG$  by ASA.

PTS: 6

REF: 011238ge

STA: G.G.27

TOP: Quadrilateral Proofs



**0612ge**  
**Answer Section**

- 1 ANS: 2                    PTS: 2                    REF: 061201ge            STA: G.G.59  
TOP: Properties of Transformations
- 2 ANS: 2                    PTS: 2                    REF: 061202ge            STA: G.G.24  
TOP: Negations
- 3 ANS: 4                    PTS: 2                    REF: 061203ge            STA: G.G.9  
TOP: Planes
- 4 ANS: 1

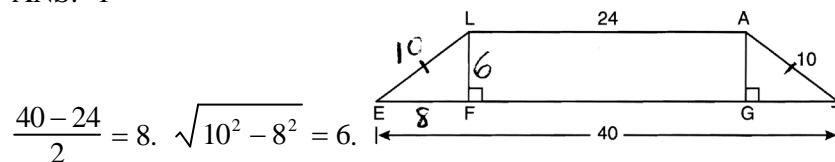

- PTS: 2                    REF: 061204ge            STA: G.G.40            TOP: Trapezoids
- 5 ANS: 3  
 $\frac{180-70}{2} = 55$

- PTS: 2                    REF: 061205ge            STA: G.G.52            TOP: Chords
- 6 ANS: 2  
 $AC = BD$   
 $AC - BC = BD - BC$   
 $AB = CD$

- PTS: 2                    REF: 061206ge            STA: G.G.27            TOP: Line Proofs
- 7 ANS: 2  
 $V = \frac{4}{3} \pi r^3 = \frac{4}{3} \pi \cdot \left(\frac{15}{2}\right)^3 \approx 1767.1$

- PTS: 2                    REF: 061207ge            STA: G.G.16            TOP: Volume and Surface Area
- 8 ANS: 2                    PTS: 2                    REF: 061208ge            STA: G.G.19  
TOP: Constructions
- 9 ANS: 1

The diagonals of a parallelogram intersect at their midpoints.  $M_{AC} \left( \frac{1+3}{2}, \frac{5+(-1)}{2} \right) = (2, 2)$

- PTS: 2                    REF: 061209ge            STA: G.G.69            TOP: Quadrilaterals in the Coordinate Plane
- 10 ANS: 3                    PTS: 2                    REF: 061210ge            STA: G.G.71  
TOP: Equations of Circles

11 ANS: 4

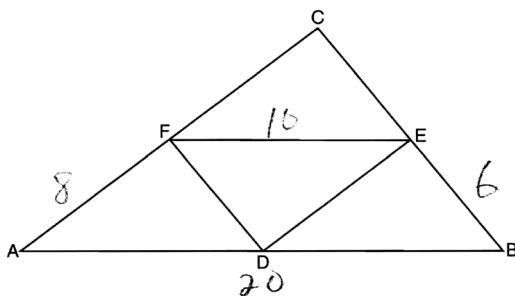

$$20 + 8 + 10 + 6 = 44.$$

PTS: 2

REF: 061211ge

STA: G.G.42

TOP: Midsegments

12 ANS: 1

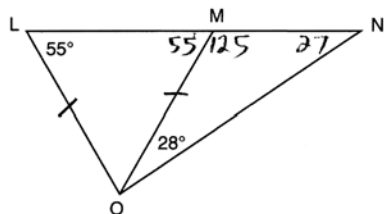

PTS: 2

REF: 061211ge

STA: G.G.31

TOP: Isosceles Triangle Theorem

13 ANS: 4

PTS: 2

REF: 061213ge

STA: G.G.5

TOP: Planes

14 ANS: 1

PTS: 2

REF: 061214ge

STA: G.G.21

TOP: Centroid, Orthocenter, Incenter and Circumcenter

15 ANS: 4

$$m_{\perp} = -\frac{1}{3}. \quad y = mx + b$$

$$6 = -\frac{1}{3}(-9) + b$$

$$6 = 3 + b$$

$$3 = b$$

PTS: 2

REF: 061215ge

STA: G.G.64

TOP: Parallel and Perpendicular Lines

16 ANS: 3

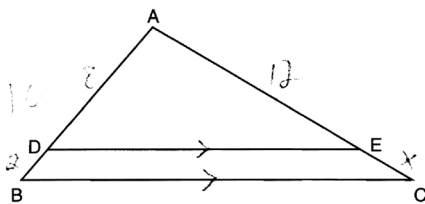

$$\frac{8}{2} = \frac{12}{x}$$

$$8x = 24$$

$$x = 3$$

PTS: 2

REF: 061216ge

STA: G.G.46

TOP: Side Splitter Theorem

17 ANS: 3

$$d = \sqrt{(-1-4)^2 + (0-(-3))^2} = \sqrt{25+9} = \sqrt{34}$$

PTS: 2 REF: 061217ge STA: G.G.67 TOP: Distance  
KEY: general

18 ANS: 3 PTS: 2 REF: 061218ge STA: G.G.36  
TOP: Interior and Exterior Angles of Polygons

19 ANS: 2

$$m = \frac{-A}{B} = \frac{-20}{-2} = 10. \quad m_{\perp} = -\frac{1}{10}$$

PTS: 2 REF: 061219ge STA: G.G.62 TOP: Parallel and Perpendicular Lines

20 ANS: 3 PTS: 2 REF: 061220ge STA: G.G.74  
TOP: Graphing Circles

21 ANS: 2

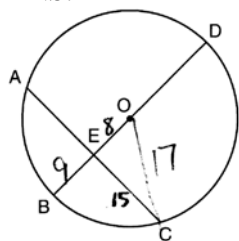

$$\sqrt{17^2 - 15^2} = 8. \quad 17 - 8 = 9$$

PTS: 2 REF: 061221ge STA: G.G.49 TOP: Chords

22 ANS: 3

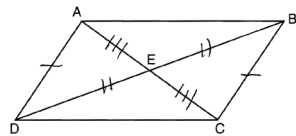

. Opposite sides of a parallelogram are congruent and the diagonals of a parallelogram bisect each other.

PTS: 2 REF: 061222ge STA: G.G.28 TOP: Triangle Congruency

23 ANS: 1 PTS: 2 REF: 061223ge STA: G.G.73  
TOP: Equations of Circles

24 ANS: 3 PTS: 2 REF: 061224ge STA: G.G.45  
TOP: Similarity KEY: basic

25 ANS: 4

$$x^2 - 6x + 2x - 3 = 9x + 27$$

$$x^2 - 4x - 3 = 9x + 27$$

$$x^2 - 13x - 30 = 0$$

$$(x - 15)(x + 2) = 0$$

$$x = 15, -2$$

PTS: 2 REF: 061225ge STA: G.G.32 TOP: Exterior Angle Theorem

26 ANS: 4

$$m = \frac{-A}{B} = \frac{-3}{2}. \quad y = mx + b$$

$$-1 = \left(\frac{-3}{2}\right)(2) + b$$

$$-1 = -3 + b$$

$$2 = b$$

PTS: 2                      REF: 061226ge                      STA: G.G.65                      TOP: Parallel and Perpendicular Lines

27 ANS: 2                      PTS: 2                      REF: 061227ge                      STA: G.G.56  
TOP: Identifying Transformations

28 ANS: 3                      PTS: 2                      REF: 061228ge                      STA: G.G.39  
TOP: Special Parallelograms

29 ANS:

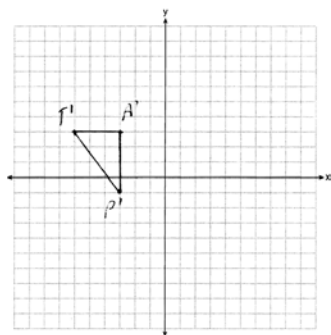

$T'(-6, 3), A'(-3, 3), P'(-3, -1)$

PTS: 2                      REF: 061229ge                      STA: G.G.54                      TOP: Translations

30 ANS:  
 $180 - (90 + 63) = 27$

PTS: 2                      REF: 061230ge                      STA: G.G.35                      TOP: Parallel Lines and Transversals

31 ANS:  
The slope of  $x + 2y = 4$  is  $m = \frac{-A}{B} = \frac{-1}{2}$ . The slope of  $4y - 2x = 12$  is  $\frac{-A}{B} = \frac{2}{4} = \frac{1}{2}$ . Since the slopes are neither equal nor opposite reciprocals, the lines are neither parallel nor perpendicular.

PTS: 2                      REF: 061231ge                      STA: G.G.63                      TOP: Parallel and Perpendicular Lines

32 ANS:

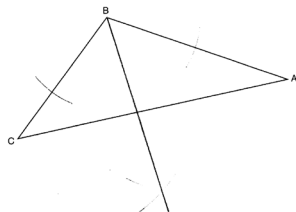

PTS: 2                      REF: 061232ge                      STA: G.G.17                      TOP: Constructions

33 ANS:

$$L = 2\pi rh = 2\pi \cdot 12 \cdot 22 \approx 1659. \quad \frac{1659}{600} \approx 2.8. \quad \text{3 cans are needed.}$$

PTS: 2

REF: 061233ge

STA: G.G.14

TOP: Lateral Area

34 ANS:

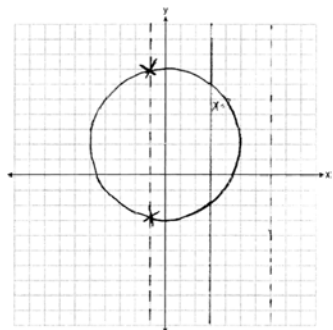

PTS: 2

REF: 061234ge

STA: G.G.23

TOP: Locus

35 ANS:

$\angle B$  and  $\angle C$  are right angles because perpendicular lines form right angles.  $\angle B \cong \angle C$  because all right angles are congruent.  $\angle AEB \cong \angle DEC$  because vertical angles are congruent.  $\triangle ABE \cong \triangle DCE$  because of ASA.  $\overline{AB} \cong \overline{DC}$  because CPCTC.

PTS: 4

REF: 061235ge

STA: G.G.27

TOP: Triangle Proofs

36 ANS:

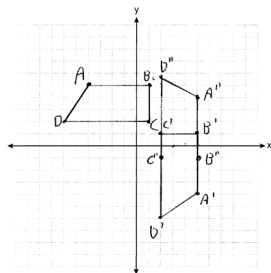

$$A'(5, -4), B'(5, 1), C'(2, 1), D'(2, -6); A''(5, 4), B''(5, -1), C''(2, -1), D''(2, 6)$$

PTS: 4

REF: 061236ge

STA: G.G.58

TOP: Compositions of Transformations

KEY: grids

37 ANS:

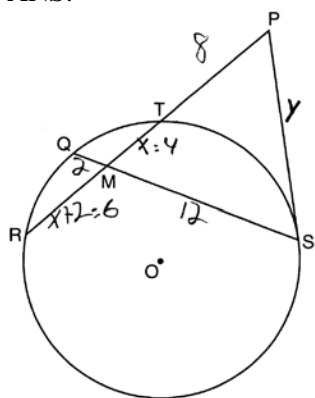

$$x(x+2) = 12 \cdot 2. \quad \overline{RT} = 6+4 = 10. \quad y \cdot y = 18 \cdot 8$$

$$x^2 + 2x - 24 = 0 \qquad y^2 = 144$$

$$(x+6)(x-4) = 0 \qquad y = 12$$

$$x = 4$$

PTS: 4      REF: 061237ge      STA: G.G.53      TOP: Segments Intercepted by Circle  
 KEY: tangent and secant

38 ANS:

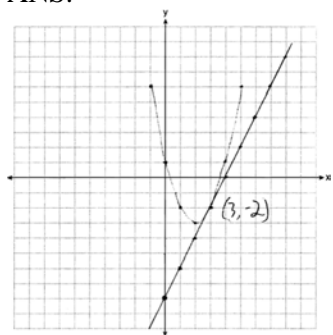

PTS: 6      REF: 061238ge      STA: G.G.70      TOP: Quadratic-Linear Systems

## 0812ge

## Answer Section

1 ANS: 4

Parallel lines intercept congruent arcs.

PTS: 2

REF: 081201ge

STA: G.G.52

TOP: Chords

2 ANS: 2

PTS: 2

REF: 081202ge

STA: G.G.55

TOP: Properties of Transformations

3 ANS: 4

$$-5 = \frac{-3+x}{2}, \quad 2 = \frac{6+y}{2}$$

$$-10 = -3 + x \quad 4 = 6 + y$$

$$-7 = x \quad -2 = y$$

PTS: 2

REF: 081203ge

STA: G.G.66

TOP: Midpoint

4 ANS: 3

PTS: 2

REF: 081204ge

STA: G.G.59

TOP: Properties of Transformations

5 ANS: 2

PTS: 2

REF: 081205ge

STA: G.G.17

TOP: Constructions

6 ANS: 4

PTS: 2

REF: 081206ge

STA: G.G.30

TOP: Interior and Exterior Angles of Triangles

7 ANS: 1

$$AB = CD$$

$$AB + BC = CD + BC$$

$$AC = BD$$

PTS: 2

REF: 081207ge

STA: G.G.27

TOP: Triangle Proofs

8 ANS: 3

PTS: 2

REF: 081208ge

STA: G.G.27

TOP: Quadrilateral Proofs

9 ANS: 3

PTS: 2

REF: 081209ge

STA: G.G.71

TOP: Equations of Circles

10 ANS: 1

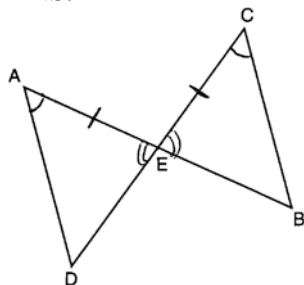

PTS: 2

REF: 081210ge

STA: G.G.28

TOP: Triangle Congruency

11 ANS: 4

PTS: 2

REF: 081211ge

STA: G.G.5

TOP: Planes

12 ANS: 2                   PTS: 2                   REF: 081212ge           STA: G.G.72  
TOP: Equations of Circles

13 ANS: 3  
 $4x + 14 + 8x + 10 = 180$   
 $12x = 156$   
 $x = 13$

PTS: 2                   REF: 081213ge           STA: G.G.35           TOP: Parallel Lines and Transversals  
14 ANS: 2                   PTS: 2                   REF: 081214ge           STA: G.G.50  
TOP: Tangents           KEY: point of tangency

15 ANS: 2  
 $V = \frac{4}{3} \pi r^3 = \frac{4}{3} \pi \cdot \left(\frac{6}{2}\right)^3 \approx 36\pi$

PTS: 2                   REF: 081215ge           STA: G.G.16           TOP: Volume and Surface Area  
16 ANS: 4                   PTS: 2                   REF: 081216ge           STA: G.G.45  
TOP: Similarity           KEY: basic

17 ANS: 1  
 $m = \frac{3}{2} \quad y = mx + b$   
 $2 = \frac{3}{2}(1) + b$   
 $\frac{1}{2} = b$

PTS: 2                   REF: 081217ge           STA: G.G.65           TOP: Parallel and Perpendicular Lines  
18 ANS: 3                   PTS: 2                   REF: 081218ge           STA: G.G.1  
TOP: Planes

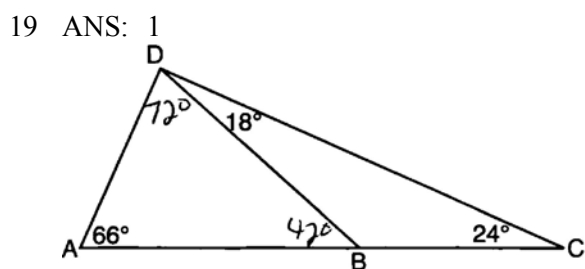

PTS: 2                   REF: 081219ge           STA: G.G.34           TOP: Angle Side Relationship  
20 ANS: 4  
The centroid divides each median into segments whose lengths are in the ratio 2 : 1.

PTS: 2                   REF: 081220ge           STA: G.G.43           TOP: Centroid



21 ANS: 1

The length of the midsegment of a trapezoid is the average of the lengths of its bases.  $\frac{x+3+5x-9}{2} = 2x+2$ .

$$6x - 6 = 4x + 4$$

$$2x = 10$$

$$x = 5$$

PTS: 2 REF: 081221ge STA: G.G.40 TOP: Trapezoids

22 ANS: 2

$$3x + x + 20 + x + 20 = 180$$

$$5x = 40$$

$$x = 28$$

PTS: 2 REF: 081222ge STA: G.G.31 TOP: Isosceles Triangle Theorem

23 ANS: 3

$$180(n-2) = n \left( 180 - \frac{180(n-2)}{n} \right)$$

$$180n - 360 = 180n - 180n + 360$$

$$180n = 720$$

$$n = 4$$

PTS: 2 REF: 081223ge STA: G.G.36 TOP: Interior and Exterior Angles of Polygons

24 ANS: 4 PTS: 2 REF: 081224ge STA: G.G.21

TOP: Centroid, Orthocenter, Incenter and Circumcenter

25 ANS: 3

The slope of  $9x - 3y = 27$  is  $m = \frac{-A}{B} = \frac{-9}{-3} = 3$ , which is the opposite reciprocal of  $-\frac{1}{3}$ .

PTS: 2 REF: 081225ge STA: G.G.62 TOP: Parallel and Perpendicular Lines

26 ANS: 2 PTS: 2 REF: 081226ge STA: G.G.69

TOP: Triangles in the Coordinate Plane

27 ANS: 3 PTS: 2 REF: 081227ge STA: G.G.42

TOP: Midsegments

28 ANS: 3

The slope of  $2y = x + 2$  is  $\frac{1}{2}$ , which is the opposite reciprocal of  $-2$ .  $3 = -2(4) + b$

$$11 = b$$

PTS: 2 REF: 081228ge STA: G.G.64 TOP: Parallel and Perpendicular Lines

29 ANS:

2 is not a prime number, false.

PTS: 2 REF: 081229ge STA: G.G.24 TOP: Negations

30 ANS:

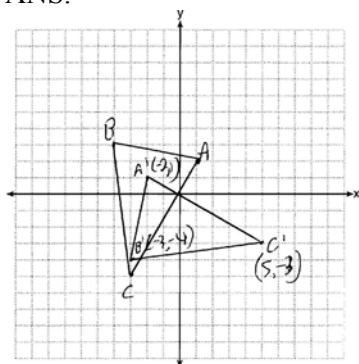

$A'(-2, 1)$ ,  $B'(-3, -4)$ , and  $C'(5, -3)$

PTS: 2 REF: 081230ge STA: G.G.54 TOP: Rotations

31 ANS:

$$V = \pi r^2 h = \pi(5)^2 \cdot 7 = 175\pi$$

PTS: 2 REF: 081231ge STA: G.G.14 TOP: Volume

32 ANS:

$$\sqrt{(-4-2)^2 + (3-5)^2} = \sqrt{36+4} = \sqrt{40} = \sqrt{4} \sqrt{10} = 2\sqrt{10}.$$

PTS: 2 REF: 081232ge STA: G.G.67 TOP: Distance

33 ANS:

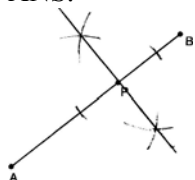

PTS: 2 REF: 081233ge STA: G.G.19 TOP: Constructions

34 ANS:

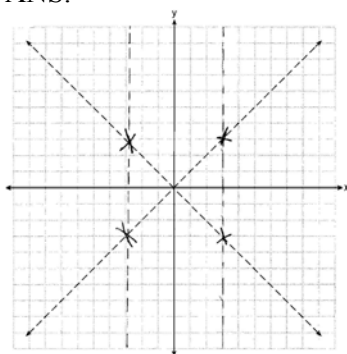

PTS: 2 REF: 081234ge STA: G.G.23 TOP: Locus

35 ANS:

$$11. \quad x^2 + 6x = x + 14. \quad 6(2) - 1 = 11$$

$$x^2 + 5x - 14 = 0$$

$$(x + 7)(x - 2) = 0$$

$$x = 2$$

PTS: 2

REF: 081235ge

STA: G.G.38

TOP: Parallelograms

36 ANS:

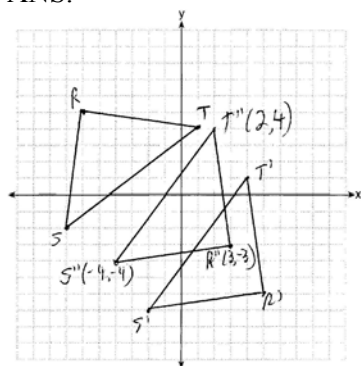

PTS: 4

REF: 081236ge

STA: G.G.58

TOP: Compositions of Transformations

KEY: grids

37 ANS:

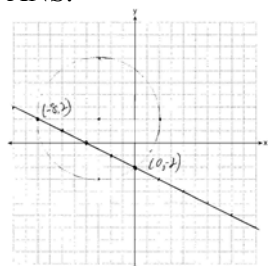

PTS: 4

REF: 081237ge

STA: G.G.70

TOP: Quadratic-Linear Systems

38 ANS:

$$52, 40, 80. \quad 360 - (56 + 112) = 192. \quad \frac{192 - 112}{2} = 40. \quad \frac{112 + 48}{2} = 80$$

$$\frac{1}{4} \times 192 = 48$$

$$\frac{56 + 48}{2} = 52$$

PTS: 6

REF: 081238ge

STA: G.G.51

TOP: Arcs Determined by Angles

KEY: mixed

**0113ge**  
**Answer Section**

1 ANS: 1                      PTS: 2                      REF: 011301ge                      STA: G.G.29  
TOP: Triangle Congruency

2 ANS: 2

Parallel chords intercept congruent arcs.  $\frac{360 - (104 + 168)}{2} = 44$

PTS: 2                      REF: 011302ge                      STA: G.G.52                      TOP: Chords

3 ANS: 1                      PTS: 2                      REF: 011303ge                      STA: G.G.24

TOP: Statements

4 ANS: 3                      PTS: 2                      REF: 011304ge                      STA: G.G.56

TOP: Identifying Transformations

5 ANS: 3

$$6 = \frac{4+x}{2}. \quad 8 = \frac{2+y}{2}.$$

$$4 + x = 12 \quad 2 + y = 16$$

$$x = 8 \quad y = 14$$

PTS: 2                      REF: 011305ge                      STA: G.G.66                      TOP: Midpoint

6 ANS: 4                      PTS: 2                      REF: 011306ge                      STA: G.G.9

TOP: Planes

7 ANS: 2

Perimeter of  $\triangle DEF$  is  $5 + 8 + 11 = 24$ .  $\frac{5}{24} = \frac{x}{60}$

$$24x = 300$$

$$x = 12.5$$

PTS: 2                      REF: 011307ge                      STA: G.G.45                      TOP: Similarity

KEY: perimeter and area

8 ANS: 1

$$x^2 = 3 \times 12$$

$$x = 6$$

PTS: 2                      REF: 011308ge                      STA: G.G.47                      TOP: Similarity

KEY: altitude

9 ANS: 3                      PTS: 2                      REF: 011309ge                      STA: G.G.20

TOP: Constructions

10 ANS: 2

The slope of  $2x + 4y = 12$  is  $m = \frac{-A}{B} = \frac{-2}{4} = -\frac{1}{2}$ .  $m_{\perp} = 2$ .

PTS: 2                      REF: 011310ge                      STA: G.G.62                      TOP: Parallel and Perpendicular Lines

- 11 ANS: 3                      PTS: 2                      REF: 011311ge                      STA: G.G.42  
TOP: Midsegments
- 12 ANS: 3  
 $x^2 + 5^2 = 25$   
 $x = 0$
- PTS: 2                      REF: 011312ge                      STA: G.G.70                      TOP: Quadratic-Linear Systems
- 13 ANS: 2  
 $\sqrt{(-2-4)^2 + (-3-(-1))^2} = \sqrt{40} = \sqrt{4} \sqrt{10} = 2\sqrt{10}$
- PTS: 2                      REF: 011313ge                      STA: G.G.39                      TOP: Special Parallelograms
- 14 ANS: 1  
 $\frac{180-52}{2} = 64. \quad 180 - (90 + 64) = 26$
- PTS: 2                      REF: 011314ge                      STA: G.G.30                      TOP: Interior and Exterior Angles of Triangles
- 15 ANS: 4                      PTS: 2                      REF: 011315ge                      STA: G.G.1  
TOP: Planes
- 16 ANS: 2  
 $2^2 + 3^2 \neq 4^2$
- PTS: 2                      REF: 011316ge                      STA: G.G.48                      TOP: Pythagorean Theorem
- 17 ANS: 2                      PTS: 2                      REF: 011317ge                      STA: G.G.22  
TOP: Locus
- 18 ANS: 4                      PTS: 2                      REF: 011318ge                      STA: G.G.73  
TOP: Equations of Circles
- 19 ANS: 4  
 $m = \frac{2}{3} \quad . \quad 2 = -\frac{3}{2}(4) + b$   
 $m_{\perp} = -\frac{3}{2} \quad 2 = -6 + b$   
 $8 = b$
- PTS: 2                      REF: 011319ge                      STA: G.G.64                      TOP: Parallel and Perpendicular Lines
- 20 ANS: 1                      PTS: 2                      REF: 011320ge                      STA: G.G.26  
TOP: Conditional Statements
- 21 ANS: 3  
 $2(4x + 20) + 2(3x - 15) = 360. \quad \angle D = 3(25) - 15 = 60$   
 $8x + 40 + 6x - 30 = 360$   
 $14x + 10 = 360$   
 $14x = 350$   
 $x = 25$
- PTS: 2                      REF: 011321ge                      STA: G.G.40                      TOP: Trapezoids

- 22 ANS: 3                      PTS: 2                      REF: 011322ge                      STA: G.G.49  
TOP: Chords
- 23 ANS: 4                      PTS: 2                      REF: 011323ge                      STA: G.G.72  
TOP: Equations of Circles
- 24 ANS: 3  
$$m = \frac{-A}{B} = \frac{-3}{-2} = \frac{3}{2}$$
- PTS: 2                      REF: 011324ge                      STA: G.G.63                      TOP: Parallel and Perpendicular Lines
- 25 ANS: 1  
$$\frac{70 - 20}{2} = 25$$
- PTS: 2                      REF: 011325ge                      STA: G.G.51                      TOP: Arcs Determined by Angles  
KEY: outside circle
- 26 ANS: 2  
$$\frac{(n-2)180}{n} = 120 .$$
  
$$180n - 360 = 120n$$
$$60n = 360$$
$$n = 6$$
- PTS: 2                      REF: 011326ge                      STA: G.G.37                      TOP: Interior and Exterior Angles of Polygons
- 27 ANS: 4  
 $2x - 8 = x + 2$ .  $AE = 10 + 2 = 12$ .  $AC = 2(AE) = 2(12) = 24$   
 $x = 10$
- PTS: 2                      REF: 011327ge                      STA: G.G.39                      TOP: Special Parallelograms
- 28 ANS: 3  
 $AB = 8 - 4 = 4$ .  $BC = \sqrt{(-2 - (-5))^2 + (8 - 6)^2} = \sqrt{13}$ .  $AC = \sqrt{(-2 - (-5))^2 + (4 - 6)^2} = \sqrt{13}$
- PTS: 2                      REF: 011328ge                      STA: G.G.69                      TOP: Triangles in the Coordinate Plane
- 29 ANS:  
Distance is preserved after the reflection.  $2x + 13 = 9x - 8$   
$$21 = 7x$$
$$3 = x$$
- PTS: 2                      REF: 011329ge                      STA: G.G.55                      TOP: Properties of Transformations

30 ANS:

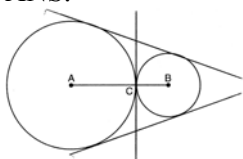

PTS: 2 REF: 011330ge STA: G.G.50 TOP: Tangents  
 KEY: common tangency

31 ANS:

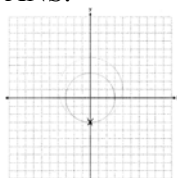

PTS: 2 REF: 011331ge STA: G.G.23 TOP: Locus

32 ANS:

If  $r = 5$ , then  $r^2 = 25$ .  $(x + 3)^2 + (y - 2)^2 = 25$

PTS: 2 REF: 011332ge STA: G.G.71 TOP: Equations of Circles

33 ANS:

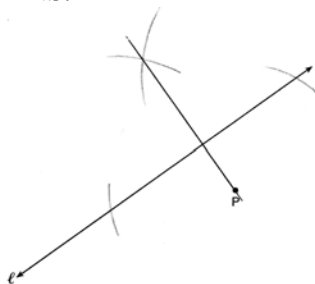

PTS: 2 REF: 011333ge STA: G.G.19 TOP: Constructions

34 ANS:

$$M = \left( \frac{3+3}{2}, \frac{-1+5}{2} \right) = (3, 2). \quad y = 2.$$

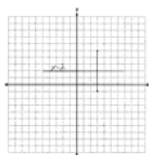

PTS: 2 REF: 011334ge STA: G.G.68 TOP: Perpendicular Bisector

35 ANS:

$$L = 2\pi r h = 2\pi \cdot 3 \cdot 5 \approx 94.25. \quad V = \pi r^2 h = \pi(3)^2(5) \approx 141.37$$

PTS: 4 REF: 011335ge STA: G.G.14 TOP: Volume

36 ANS:

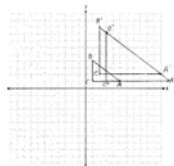
 $A''(11, 1), B''(3, 7), C''(3, 1)$ 

PTS: 4 REF: 011336ge STA: G.G.58 TOP: Compositions of Transformations

37 ANS:

$x^2 + 12 + 11x + 5 + 13x - 17 = 180$ .  $m\angle A = 6^2 + 12 = 48$ .  $\angle B$  is the largest angle, so  $\overline{AC}$  is the longest side.

$$x^2 + 24x - 180 = 0 \quad m\angle B = 11(6) + 5 = 71$$

$$(x + 30)(x - 6) = 0 \quad m\angle C = 13(6) - 7 = 61$$

$$x = 6$$

PTS: 4 REF: 011337ge STA: G.G.34 TOP: Angle Side Relationship

38 ANS:

Rectangle  $ABCD$  with points  $E$  and  $F$  on side  $\overline{AB}$ , segments  $CE$  and  $DF$  intersect at  $G$ , and  $\angle ADG \cong \angle BCE$  are given.  $\overline{AD} \cong \overline{BC}$  because opposite sides of a rectangle are congruent.  $\angle A$  and  $\angle B$  are right angles and congruent because all angles of a rectangle are right and congruent.  $\triangle ADF \cong \triangle BCE$  by ASA.  $\overline{AF} \cong \overline{BE}$  per CPCTC.  $\overline{EF} \cong \overline{FE}$  under the Reflexive Property.  $\overline{AF} - \overline{EF} \cong \overline{BE} - \overline{FE}$  using the Subtraction Property of Segments.  $\overline{AE} \cong \overline{BF}$  because of the Definition of Segments.

PTS: 6 REF: 011338ge STA: G.G.27 TOP: Quadrilateral Proofs



**0613ge**  
**Answer Section**

1 ANS: 2

Isosceles or not,  $\triangle RSV$  and  $\triangle RST$  have a common base, and since  $\overline{RS}$  and  $\overline{VT}$  are bases, congruent altitudes.

PTS: 2 REF: 061301ge STA: G.G.40 TOP: Trapezoids

2 ANS: 2

(1) is true because of vertical angles. (3) and (4) are true because CPCTC.

PTS: 2 REF: 061302ge STA: G.G.29 TOP: Triangle Congruency

3 ANS: 4

TOP: Locus

PTS: 2

REF: 061303ge

STA: G.G.22

4 ANS: 4

$(x,y) \rightarrow (-x,-y)$

PTS: 2 REF: 061304ge STA: G.G.54 TOP: Rotations

5 ANS: 2

TOP: Constructions

PTS: 2

REF: 061305ge

STA: G.G.18

6 ANS: 3

TOP: Equations of Circles

PTS: 2

REF: 061306ge

STA: G.G.71

7 ANS: 1

TOP: Properties of Transformations

PTS: 2

REF: 061307ge

STA: G.G.55

8 ANS: 3

$$3x + 1 + 4x - 17 + 5x - 20 = 180. \quad 3(18) + 1 = 55$$

$$12x - 36 = 180 \quad 4(18) - 17 = 55$$

$$12x = 216 \quad 5(18) - 20 = 70$$

$$x = 18$$

PTS: 2 REF: 061308ge STA: G.G.30 TOP: Interior and Exterior Angles of Triangles

9 ANS: 3

TOP: Equations of Circles

PTS: 2

REF: 061309ge

STA: G.G.72

10 ANS: 1

TOP: Planes

PTS: 2

REF: 061310ge

STA: G.G.2

11 ANS: 3

$$3x - 15 = 2(6)$$

$$3x = 27$$

$$x = 9$$

PTS: 2 REF: 061311ge STA: G.G.42 TOP: Midsegments

12 ANS: 2

$$M_x = \frac{8 + (-3)}{2} = 2.5. \quad M_y = \frac{-4 + 2}{2} = -1.$$

PTS: 2 REF: 061312ge STA: G.G.66 TOP: Midpoint

- 13 ANS: 2                   PTS: 2                   REF: 061313ge           STA: G.G.70  
TOP: Quadratic-Linear Systems
- 14 ANS: 1                   PTS: 2                   REF: 061314ge           STA: G.G.26  
TOP: Converse and Biconditional
- 15 ANS: 2                   PTS: 2                   REF: 061315ge           STA: G.G.13  
TOP: Classifying Solids
- 16 ANS: 3  
 $2y = 3x - 4$      $1 = \frac{3}{2}(6) + b$   
 $y = \frac{3}{2}x - 2$      $1 = 9 + b$   
                   $-8 = b$
- PTS: 2                   REF: 061316ge           STA: G.G.65           TOP: Parallel and Perpendicular Lines
- 17 ANS: 1  
 $V = \frac{4}{3}\pi r^3$   
 $44.6022 = \frac{4}{3}\pi r^3$   
 $10.648 \approx r^3$   
 $2.2 \approx r$
- PTS: 2                   REF: 061317ge           STA: G.G.16           TOP: Volume and Surface Area
- 18 ANS: 4  
 $m_{\overleftrightarrow{AB}} = \frac{6-3}{7-5} = \frac{3}{2}$  ·  $m_{\overleftrightarrow{CD}} = \frac{4-0}{6-9} = \frac{4}{-3}$
- PTS: 2                   REF: 061318ge           STA: G.G.63           TOP: Parallel and Perpendicular Lines
- 19 ANS: 4                   PTS: 2                   REF: 061319ge           STA: G.G.73  
TOP: Equations of Circles
- 20 ANS: 3                   PTS: 2                   REF: 061320ge           STA: G.G.35  
TOP: Parallel Lines and Transversals
- 21 ANS: 2                   PTS: 2                   REF: 061321ge           STA: G.G.34  
TOP: Angle Side Relationship
- 22 ANS: 2                   PTS: 2                   REF: 061322ge           STA: G.G.51  
TOP: Arcs Determined by Angles  
KEY: inscribed
- 23 ANS: 3  
 $25 \times 9 \times 12 = 15^2h$   
 $2700 = 15^2h$   
 $12 = h$
- PTS: 2                   REF: 061323ge           STA: G.G.11           TOP: Volume
- 24 ANS: 2                   PTS: 2                   REF: 061324ge           STA: G.G.44  
TOP: Similarity Proofs
- 25 ANS: 1                   PTS: 2                   REF: 061325ge           STA: G.G.74  
TOP: Graphing Circles

26 ANS: 2

$$\sqrt{8^2 + 15^2} = 17$$

PTS: 2

REF: 061326ge STA: G.G.39

TOP: Special Parallelograms

27 ANS: 3

$$x^2 = 3 \times 12. \quad \sqrt{6^2 + 3^2} = \sqrt{45} = \sqrt{9} \sqrt{5} = 3\sqrt{5}$$

$$x = 6$$

PTS: 2

REF: 061327ge STA: G.G.47

TOP: Similarity

KEY: altitude

28 ANS: 1

$$12(8) = x(6)$$

$$96 = 6x$$

$$16 = x$$

PTS: 2

REF: 061328ge STA: G.G.53

TOP: Segments Intercepted by Circle

KEY: two secants

29 ANS:

$$L = 2\pi rh = 2\pi \cdot 3 \cdot 7 = 42\pi$$

PTS: 2

REF: 061329ge STA: G.G.14

TOP: Volume

30 ANS:

$$(n-2)180 = (8-2)180 = 1080. \quad \frac{1080}{8} = 135.$$

PTS: 2

REF: 061330ge STA: G.G.37

TOP: Interior and Exterior Angles of Polygons

31 ANS:

$$\sqrt{(7-3)^2 + (-8-0)^2} = \sqrt{16+64} = \sqrt{80} = 4\sqrt{5}$$

PTS: 2

REF: 061331ge STA: G.G.69

TOP: Triangles in the Coordinate Plane

32 ANS:

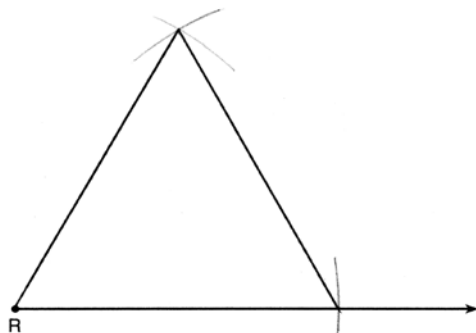

PTS: 2

REF: 061332ge STA: G.G.20

TOP: Constructions

33 ANS:

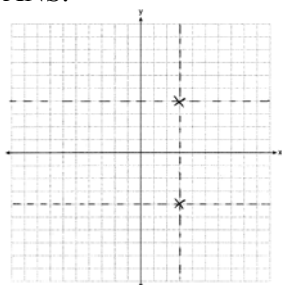

PTS: 2 REF: 061333ge STA: G.G.23 TOP: Locus

34 ANS:

$$m_{\overline{AB}} = \frac{4-1}{4-2} = \frac{3}{2} \cdot m_{\overline{BC}} = -\frac{2}{3}$$

PTS: 4 REF: 061334ge STA: G.G.69 TOP: Quadrilaterals in the Coordinate Plane

35 ANS:

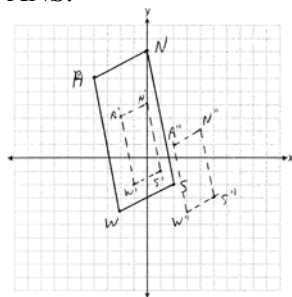
 $S''(5, -3), W''(3, -4), A''(2, 1), \text{ and } N''(4, 2)$ 
PTS: 4 REF: 061335ge STA: G.G.58 TOP: Compositions of Transformations  
KEY: grids

36 ANS:

$$2(y + 10) = 4y - 20. \overline{DF} = y + 10 = 20 + 10 = 30. \overline{OA} = \overline{OD} = \sqrt{16^2 + 30^2} = 34$$

$$2y + 20 = 4y - 20$$

$$40 = 2y$$

$$20 = y$$

PTS: 4 REF: 061336ge STA: G.G.49 TOP: Chords

37 ANS:

$$x^2 - 8x = 5x + 30. m\angle C = 4(15) - 5 = 55$$

$$x^2 - 13x - 30 = 0$$

$$(x - 15)(x + 2) = 0$$

$$x = 15$$

PTS: 4 REF: 061337ge STA: G.G.45 TOP: Similarity  
KEY: basic

38 ANS:

$\triangle MAH$ ,  $\overline{MH} \cong \overline{AH}$  and medians  $\overline{AB}$  and  $\overline{MT}$  are given.  $\overline{MA} \cong \overline{AM}$  (reflexive property).  $\triangle MAH$  is an isosceles triangle (definition of isosceles triangle).  $\angle AMB \cong \angle MAT$  (isosceles triangle theorem).  $B$  is the midpoint of  $\overline{MH}$  and  $T$  is the midpoint of  $\overline{AH}$  (definition of median).  $m\overline{MB} = \frac{1}{2} m\overline{MH}$  and  $m\overline{AT} = \frac{1}{2} m\overline{AH}$  (definition of midpoint).  $\overline{MB} \cong \overline{AT}$  (multiplication postulate).  $\triangle MBA \cong \triangle ATM$  (SAS).  $\angle MBA \cong \angle ATM$  (CPCTC).

PTS: 6

REF: 061338ge

STA: G.G.27

TOP: Triangle Proofs

## 0813ge

## Answer Section

- 1 ANS: 2                      PTS: 2                      REF: 081301ge                      STA: G.G.24  
TOP: Statements
- 2 ANS: 1  
Parallel chords intercept congruent arcs.  $m\widehat{AC} = m\widehat{BD}$ .  $\frac{180 - 110}{2} = 35$ .
- PTS: 2                      REF: 081302ge                      STA: G.G.52                      TOP: Chords
- 3 ANS: 1                      PTS: 2                      REF: 081303ge                      STA: G.G.24  
TOP: Negations
- 4 ANS: 4  
Distance is preserved after a rotation.
- PTS: 2                      REF: 081304ge                      STA: G.G.55                      TOP: Properties of Transformations
- 5 ANS: 4                      PTS: 2                      REF: 081305ge                      STA: G.G.71  
TOP: Equations of Circles
- 6 ANS: 2                      PTS: 2                      REF: 081306ge                      STA: G.G.34  
TOP: Angle Side Relationship
- 7 ANS: 3  
The centroid divides each median into segments whose lengths are in the ratio 2 : 1.
- PTS: 2                      REF: 081307ge                      STA: G.G.43                      TOP: Centroid
- 8 ANS: 4                      PTS: 2                      REF: 081308ge                      STA: G.G.49  
TOP: Chords
- 9 ANS: 3                      PTS: 2                      REF: 081309ge                      STA: G.G.29  
TOP: Triangle Congruency
- 10 ANS: 4  
 $6x = x + 40 + 3x + 10$ .  $m\angle CAB = 25 + 40 = 65$   
 $6x = 4x + 50$   
 $2x = 50$   
 $x = 25$
- PTS: 2                      REF: 081310ge                      STA: G.G.32                      TOP: Exterior Angle Theorem
- 11 ANS: 2                      PTS: 2                      REF: 081311ge                      STA: G.G.10  
TOP: Solids
- 12 ANS: 3                      PTS: 2                      REF: 081312ge                      STA: G.G.72  
TOP: Equations of Circles
- 13 ANS: 4                      PTS: 2                      REF: 081313ge                      STA: G.G.19  
TOP: Constructions
- 14 ANS: 3  
 $120\pi = \pi(12)(l)$   
 $10 = l$
- PTS: 2                      REF: 081314ge                      STA: G.G.15                      TOP: Volume and Lateral Area

15 ANS: 4

$$3y + 6 = 2x \quad 2y - 3x = 6$$

$$3y = 2x - 6 \quad 2y = 3x + 6$$

$$y = \frac{2}{3}x - 2 \quad y = \frac{3}{2}x + 3$$

$$m = \frac{2}{3} \quad m = \frac{3}{2}$$

PTS: 2 REF: 081315ge STA: G.G.63 TOP: Parallel and Perpendicular Lines

16 ANS: 2 PTS: 2 REF: 081316ge STA: G.G.23

TOP: Locus

17 ANS: 3

$$\frac{15}{18} = \frac{5}{6}$$

PTS: 2 REF: 081317ge STA: G.G.45 TOP: Similarity

KEY: perimeter and area

18 ANS: 4 PTS: 2 REF: 081318ge STA: G.G.26

TOP: Converse and Biconditional

19 ANS: 2

$$(x - 4)^2 - 2 = -2x + 6. \quad y = -2(4) + 6 = -2$$

$$x^2 - 8x + 16 - 2 = -2x + 6 \quad y = -2(2) + 6 = 2$$

$$x^2 - 6x + 8 = 0$$

$$(x - 4)(x - 2) = 0$$

$$x = 4, 2$$

PTS: 2 REF: 081319ge STA: G.G.70 TOP: Quadratic-Linear Systems

20 ANS: 3 PTS: 2 REF: 081320ge STA: G.G.42

TOP: Midsegments

21 ANS: 1

If two prisms have equal heights and volume, the area of their bases is equal.

PTS: 2 REF: 081321ge STA: G.G.11 TOP: Volume

22 ANS: 4

$$(n - 2)180 - n \left( \frac{(n - 2)180}{n} \right) = 180n - 360 - 180n + 180n - 360 = 180n - 720.$$

$$180(5) - 720 = 180$$

PTS: 2 REF: 081322ge STA: G.G.37 TOP: Interior and Exterior Angles of Polygons

23 ANS: 1 PTS: 2 REF: 081323ge STA: G.G.9

TOP: Planes

24 ANS: 1 PTS: 2 REF: 081324ge STA: G.G.74

TOP: Graphing Circles

25 ANS: 2  
 $\sqrt{15^2 - 12^2} = 9$

PTS: 2 REF: 081325ge STA: G.G.50 TOP: Tangents  
 KEY: point of tangency

26 ANS: 3  
 $x^2 = 2(2 + 10)$   
 $x^2 = 24$

$$x = \sqrt{24} = \sqrt{4} \sqrt{6} = 2\sqrt{6}$$

PTS: 2 REF: 081326ge STA: G.G.47 TOP: Similarity  
 KEY: leg

27 ANS: 3

midpoint:  $\left(\frac{6+8}{2}, \frac{8+4}{2}\right) = (7, 6)$ . slope:  $\frac{8-4}{6-8} = \frac{4}{-2} = -2$ ;  $m_{\perp} = \frac{1}{2}$ .  $6 = \frac{1}{2}(7) + b$

$$\frac{12}{2} = \frac{7}{2} + b$$

$$\frac{5}{2} = b$$

PTS: 2 REF: 081327ge STA: G.G.68 TOP: Perpendicular Bisector

28 ANS: 1  
 $8 \times 12 = 16x$   
 $6 = x$

PTS: 2 REF: 081328ge STA: G.G.53 TOP: Segments Intercepted by Circle  
 KEY: two chords

29 ANS:  
 $A'(2, 2), B'(3, 0), C(1, -1)$

PTS: 2 REF: 081329ge STA: G.G.58 TOP: Dilations

30 ANS:

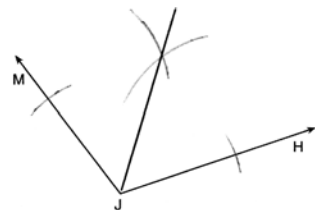

PTS: 2 REF: 081330ge STA: G.G.17 TOP: Constructions

31 ANS:  
 $\sqrt{(-1-3)^2 + (4-(-2))^2} = \sqrt{16+36} = \sqrt{52} = \sqrt{4} \sqrt{13} = 2\sqrt{13}$

PTS: 2 REF: 081331ge STA: G.G.67 TOP: Distance



32 ANS:

$$A = 2B - 15 \quad . \quad 2B - 15 + B + 2B - 15 + B = 180$$

$$C = A + B \qquad \qquad \qquad 6B - 30 = 180$$

$$C = 2B - 15 + B \qquad \qquad \qquad 6B = 210$$

$$B = 35$$

PTS: 2                      REF: 081332ge              STA: G.G.30              TOP: Interior and Exterior Angles of Triangles

33 ANS:

center: (3, -4); radius:  $\sqrt{10}$

PTS: 2                      REF: 081333ge              STA: G.G.73              TOP: Equations of Circles

34 ANS:

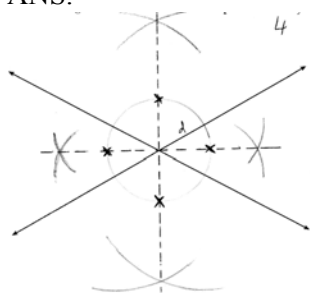

PTS: 2                      REF: 081334ge              STA: G.G.22              TOP: Locus

35 ANS:

$\triangle ABC$ ,  $\overline{BD}$  bisects  $\angle ABC$ ,  $\overline{BD} \perp \overline{AC}$  (Given).  $\angle CBD \cong \angle ABD$  (Definition of angle bisector).  $\overline{BD} \cong \overline{BD}$  (Reflexive property).  $\angle CDB$  and  $\angle ADB$  are right angles (Definition of perpendicular).  $\angle CDB \cong \angle ADB$  (All right angles are congruent).  $\triangle CDB \cong \triangle ADB$  (SAS).  $\overline{AB} \cong \overline{CB}$  (CPCTC).

PTS: 4                      REF: 081335ge              STA: G.G.27              TOP: Triangle Proofs

36 ANS:

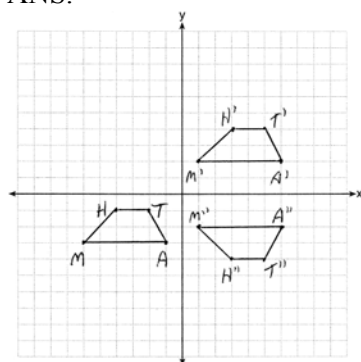

$M'''(1, -2), A'''(6, -2), T'''(5, -4), H'''(3, -4)$

PTS: 4                      REF: 081336ge              STA: G.G.58              TOP: Compositions of Transformations  
KEY: grids

37 ANS:

$$12x - 4 + 180 - 6x + 6x + 7x + 13 = 360. \quad 16y + 1 = \frac{12y + 1 + 18y + 6}{2}$$

$$19x + 189 = 360 \quad 32y + 2 = 30y + 7$$

$$19x = 171 \quad 2y = 5$$

$$x = 9 \quad y = \frac{5}{2}$$

PTS: 4

REF: 081337ge

STA: G.G.40

TOP: Trapezoids

38 ANS:

$$M\left(\frac{-7+3}{2}, \frac{4+6}{2}\right) = M(-5, 5). \quad m_{\overline{MN}} = \frac{5-3}{-5-0} = \frac{2}{-5}. \quad \text{Since both opposite sides have equal slopes and are}$$

$$N\left(\frac{-3+3}{2}, \frac{6+0}{2}\right) = N(0, 3) \quad m_{\overline{PQ}} = \frac{-4-2}{2-3} = \frac{-2}{-1} = \frac{2}{1}$$

$$P\left(\frac{3+1}{2}, \frac{0+8}{2}\right) = P(2, 4) \quad m_{\overline{NA}} = \frac{3-4}{0-2} = \frac{-1}{-2} = \frac{1}{2}$$

$$Q\left(\frac{-7+1}{2}, \frac{4+8}{2}\right) = Q(-3, 6) \quad m_{\overline{QM}} = \frac{-2-5}{-3-5} = \frac{-7}{-8} = \frac{7}{8}$$

parallel,  $MNPQ$  is a parallelogram.  $\overline{MN} = \sqrt{(-5-0)^2 + (5-3)^2} = \sqrt{29}$ .  $\overline{MN}$  is not congruent to  $\overline{NP}$ , so  $MNPQ$

$$\overline{NA} = \sqrt{(0-2)^2 + (3-4)^2} = \sqrt{5}$$

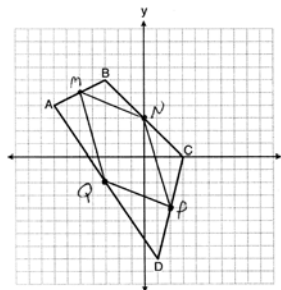

is not a rhombus since not all sides are congruent.

PTS: 6

REF: 081338ge

STA: G.G.69

TOP: Quadrilaterals in the Coordinate Plane